

EVALUATION KIT
AVAILABLE

MAXIM

Low-Noise, 2.5GHz Downconverter Mixer

MAX2690

General Description

The MAX2690 is a miniature, low-noise, low-power downconverter mixer designed for use in portable consumer equipment. Signals at the RF input port are mixed with signals at the local-oscillator (LO) port using a double-balanced mixer. The RF port frequency range is 400MHz to 2500MHz. The LO port frequency range is 700MHz to 2500MHz. The IF frequency range is 10MHz to 500MHz, provided the LO and RF frequencies are chosen appropriately.

The IF port is differential, which provides good linearity and low LO emissions, as well as providing compatibility with applications using differential IF filters, such as CDMA cellular phones. The mixer noise figure is 10dB at 900MHz.

The MAX2690 draws 16mA at $V_{CC} = 3V$ and operates from a +2.7V to +5.5V supply. A logic-controlled shutdown mode reduces the supply current to less than 1 μ A, making it ideal for battery-operated equipment. This device is offered in a miniature 10-pin μ MAX package.

Applications

2.45GHz Industrial-Scientific-Medical (ISM)
Band Radios
Wireless Local Area Networks (WLANs)
Personal Communications Systems (PCS)
Code-Division Multiple Access (CDMA)
Communications Systems
Cellular and Cordless Phones
Hand-Held Radios

Pin Configuration

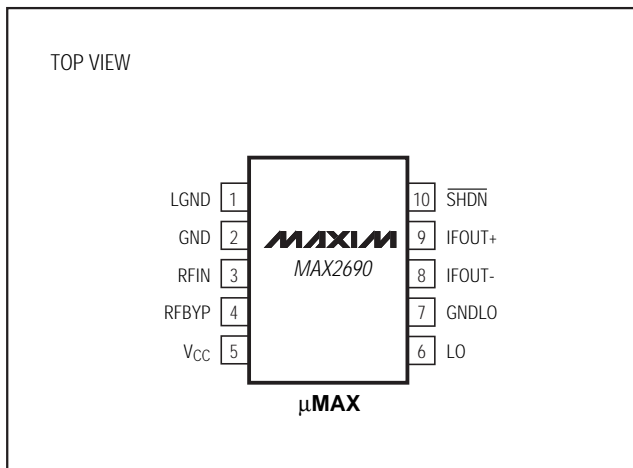

Features

- ◆ 7.6dBm Input Third-Order Intercept Point
- ◆ 10dB Downconverter Mixer Noise Figure
- ◆ 7.9dB Gain
- ◆ 400MHz to 2500MHz Wideband Operation
- ◆ Low Cost
- ◆ +2.7V to +5.5V Single-Supply Operation
- ◆ <1 μ A Shutdown Mode
- ◆ Ultra-Small 10-Pin μ MAX Package

Ordering Information

PART	TEMP. RANGE	PIN-PACKAGE
MAX2690EUB	-40°C to +85°C	10 μ MAX

Typical Operating Circuit appears at end of data sheet.

Functional Diagram

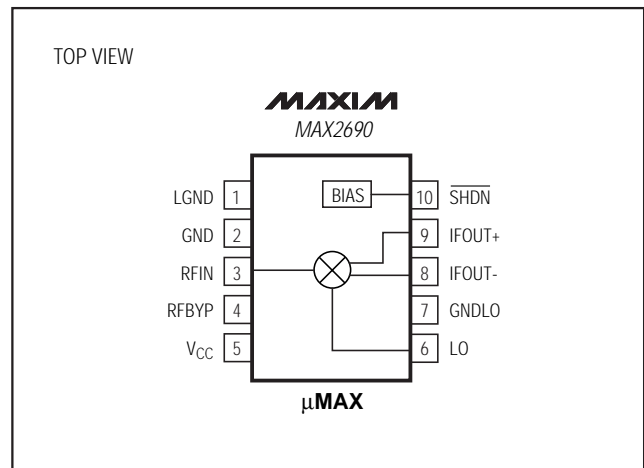

Low-Noise, 2.5GHz Downconverter Mixer

ABSOLUTE MAXIMUM RATINGS

V _{CC} to GND	-0.3V to +6.0V
RFIN Input Power	10dBm
LO Input Power	10dBm
$\overline{\text{SHDN}}$ Input Voltage	-0.3V to (V _{CC} + 0.3V)
Continuous Power Dissipation 10-Pin μ MAX (derate 4.1mW/°C above +70°C)	330mW

Operating Temperature Range MAX2690EUB	-40°C to +85°C
Junction Temperature	+150°C
Storage Temperature Range	-65°C to +165°C
Lead Temperature (soldering, 10sec)	+300°C

Stresses beyond those listed under "Absolute Maximum Ratings" may cause permanent damage to the device. These are stress ratings only, and functional operation of the device at these or any other conditions beyond those indicated in the operational sections of the specifications is not implied. Exposure to absolute maximum rating conditions for extended periods may affect device reliability.

DC ELECTRICAL CHARACTERISTICS

(V_{CC} = +2.7V to +5.5V, no RF signals applied, LO = open, IFOUT+ = IFOUT- = V_{CC}, $\overline{\text{SHDN}}$ = high, LGND = GND = GNDLO = 0V, T_A = T_{MIN} to T_{MAX}. Typical values are at V_{CC} = +3.0V and T_A = +25°C, unless otherwise noted. Minimum and maximum values are guaranteed by design and characterization over temperature.)

PARAMETER	CONDITIONS	MIN	TYP	MAX	UNITS
Operating Supply Current		9.5	16	20.1	mA
Shutdown Input Voltage High		2			V
Shutdown Input Voltage Low				0.5	V
Shutdown Supply Current	$\overline{\text{SHDN}}$ = 0V		0.4		μ A
	$\overline{\text{SHDN}}$ = low			2	
Shutdown Input Bias Current	0V < $\overline{\text{SHDN}}$ < V _{CC}	-5	4	25	μ A

AC ELECTRICAL CHARACTERISTICS

(MAX2690 EV kit; V_{CC} = +3.0V; P_{LO} = -3dBm; P_{RF} = -25dBm; $\overline{\text{SHDN}}$ = high; RFIN matched for 900MHz, 1.95GHz, and 2.45GHz as noted below. Inductor connected from LGND to GND = 39nH for 900MHz operation, 27nH for 1.95GHz operation, and 6.8nH for 2.45GHz operation. T_A = +25°C, unless otherwise noted.)

PARAMETER	CONDITIONS	MIN	TYP	MAX	UNITS
Conversion Gain (Note 1)	f _{RF} = 900MHz, f _{LO} = 1.1GHz		7.9		dB
	f _{RF} = 1.95GHz, f _{LO} = 1.75GHz		6.4		
	f _{RF} = 2.45GHz, f _{LO} = 2.1GHz		4		
Gain Variation over Temperature	f _{RF} = 1.95GHz, T _A = T _{MIN} to T _{MAX} (Note 2)		±0.6	±1.2	dB
Input Third-Order Intercept	Two tones at -25dBm per tone, f _{RF2} = 1MHz above f _{RF}	f _{RF} = 900MHz, f _{LO} = 1.1GHz		7.6	dBm
		f _{RF} = 1.95GHz, f _{LO} = 1.75GHz		5.3	
		f _{RF} = 2.45GHz, f _{LO} = 2.1GHz		4.3	
Noise-Figure Single Sideband	f _{RF} = 900MHz, f _{LO} = 1.1GHz		10		dB
	f _{RF} = 1.95GHz, f _{LO} = 1.75GHz		11.5		
	f _{RF} = 2.45GHz, f _{LO} = 2.1GHz		12		

Low-Noise, 2.5GHz Downconverter Mixer

MAX2690

AC ELECTRICAL CHARACTERISTICS (continued)

(MAX2690 EV kit: $V_{CC} = +3.0V$; $P_{LO} = -3dBm$; $P_{RF} = -25dBm$; $\overline{SHDN} = \text{high}$; R_{FIN} matched for 900MHz, 1.95GHz, and 2.45GHz as noted below. Inductor connected from LGND to GND = 39nH for 900MHz operation, 27nH for 1.95GHz operation, and 6.8nH for 2.45GHz operation. $T_A = +25^\circ C$, unless otherwise noted.)

PARAMETER	CONDITIONS	MIN	TYP	MAX	UNITS
LO Emission at IF Port	$f_{RF} = 900MHz, f_{LO} = 1.1GHz$		-32		dBm
	$f_{RF} = 1.95GHz, f_{LO} = 1.75GHz$		-32		
	$f_{RF} = 2.45GHz, f_{LO} = 2.1GHz$		-28		
LO Emission at RF Port	$f_{RF} = 900MHz, f_{LO} = 1.1GHz$		-30		dBm
	$f_{RF} = 1.95GHz, f_{LO} = 1.75GHz$		-27		
	$f_{RF} = 2.45GHz, f_{LO} = 2.1GHz$		-25		
IF/2 Spurious Response (Note 3)	RF input = -15dBm	$f_{RF} = 1.0GHz, f_{LO} = 1.1GHz$		-74	dBm
		$f_{RF} = 1.85GHz, f_{LO} = 1.75GHz$		-62	
		$f_{RF} = 2.275GHz, f_{LO} = 2.1GHz$		-56	
Turn-On Time	(Note 4)		1		μs
Turn-Off Time	(Note 4)		1.6		μs

Note 1: Consult the *Applications Information* section for information on designing a matching network.

Note 2: Guaranteed by design and characterization.

Note 3: This spurious response is caused by a higher-order mixing product (2x2). Specified RF frequency is applied and IF output power is observed at the desired IF frequency (200MHz for $f_{RF} = 900MHz$, or 1.95GHz, and 350MHz for $f_{RF} = 2.45GHz$).

Note 4: From the time \overline{SHDN} goes high to the time I_{CC} reaches 90% of its final value (on), or from the time \overline{SHDN} goes low to the time I_{CC} drops below 10 μA (off).

Low-Noise, 2.5GHz Downconverter Mixer

Typical Operating Characteristics

(MAX2690 EV kit, $V_{CC} = +3.0V$, $P_{LO} = -3dBm$, $P_{RF} = -25dBm$, $f_{RF} = 1.95GHz$, $f_{IF} = 200MHz$, $\overline{SHDN} = high$, $T_A = +25^\circ C$, unless otherwise noted.)

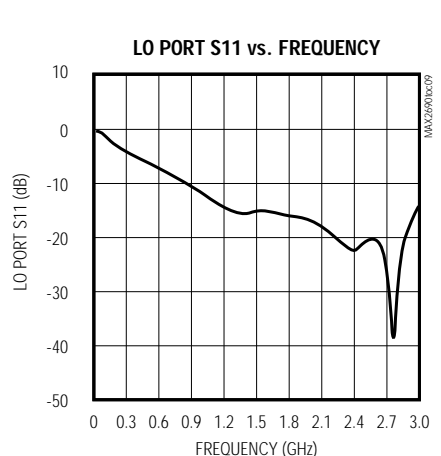
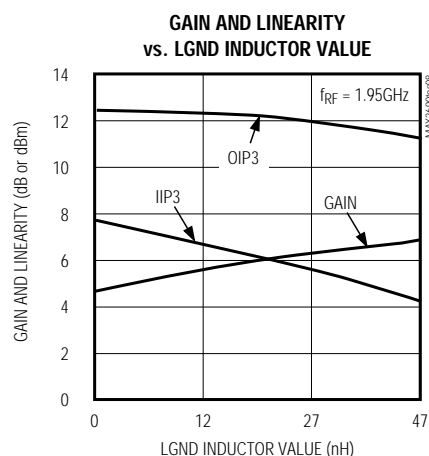
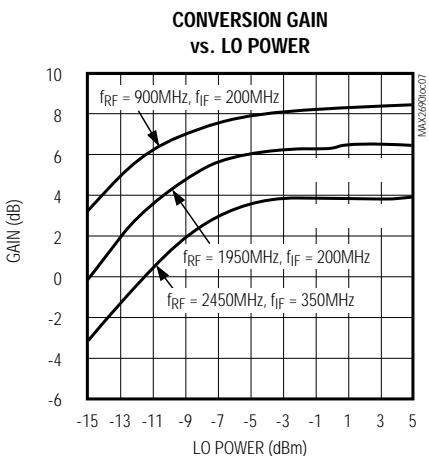
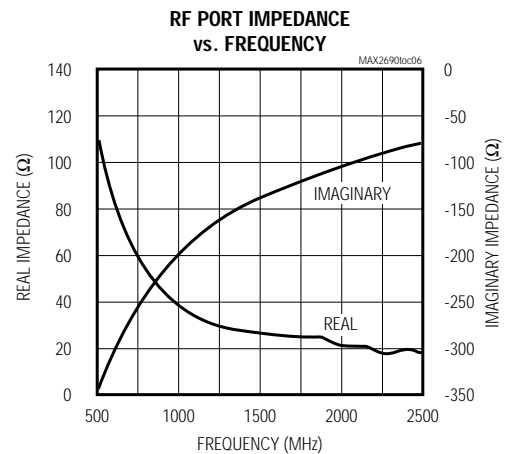
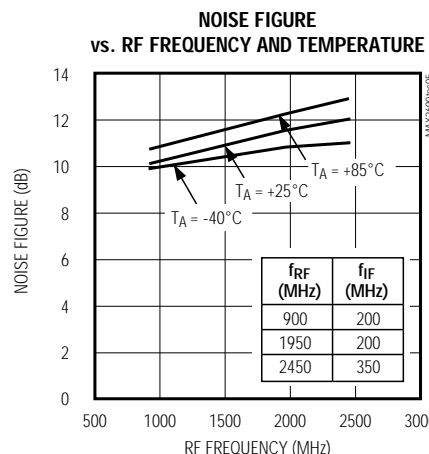
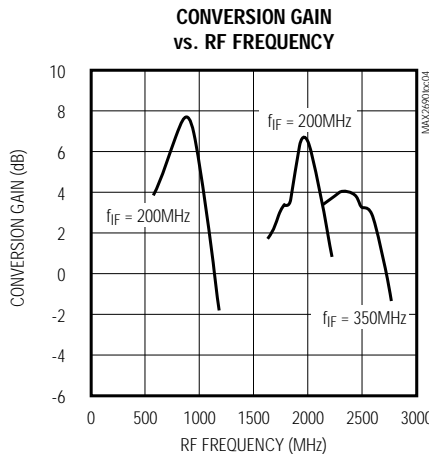
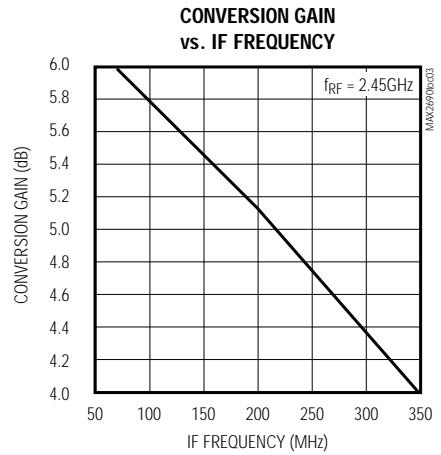
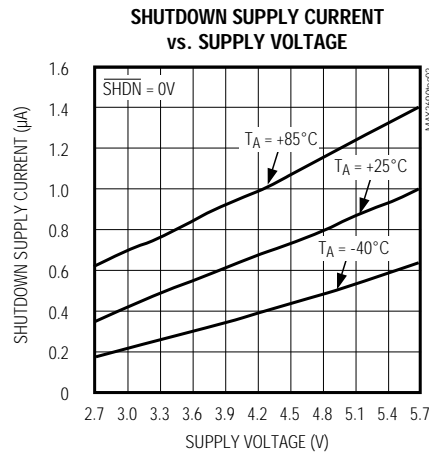
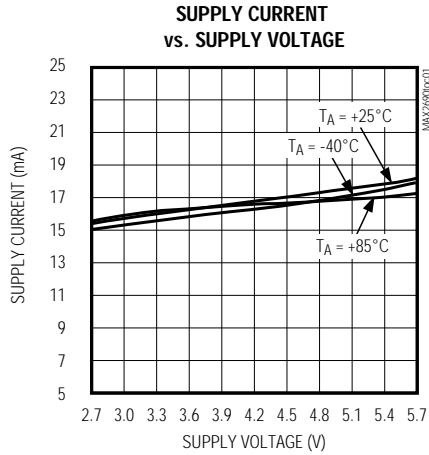

Low-Noise, 2.5GHz Downconverter Mixer

MAX2690

Typical Operating Characteristics (continued)

(MAX2690 EV kit, $V_{CC} = +3.0V$, $P_{LO} = -3dBm$, $P_{RF} = -25dBm$, $f_{RF} = 1.95GHz$, $f_{IF} = 200MHz$, $\overline{SHDN} = high$, $T_A = +25^\circ C$, unless otherwise noted.)

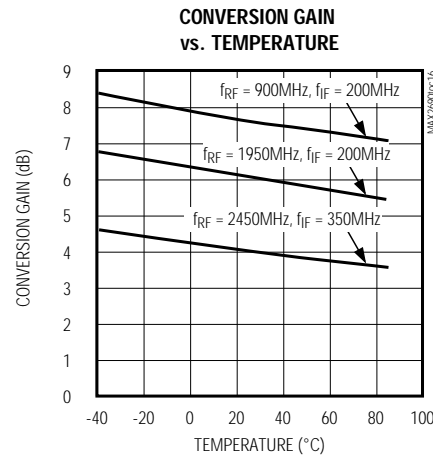
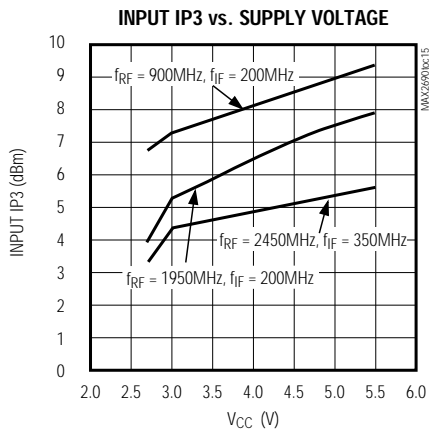
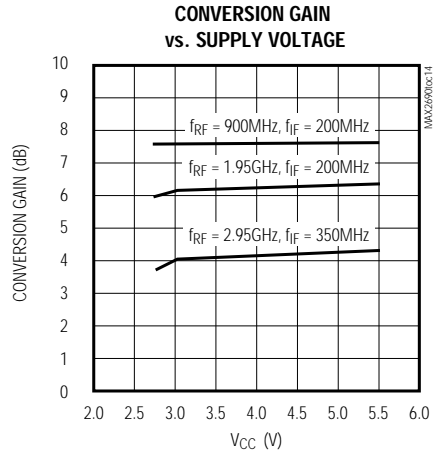
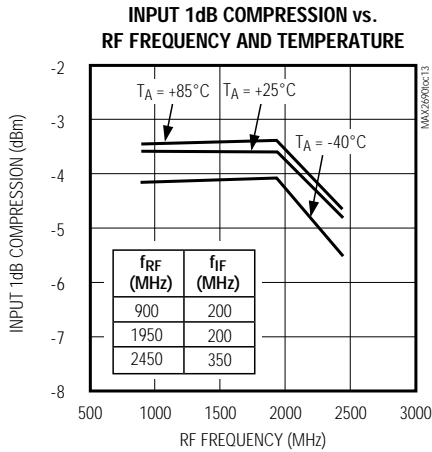
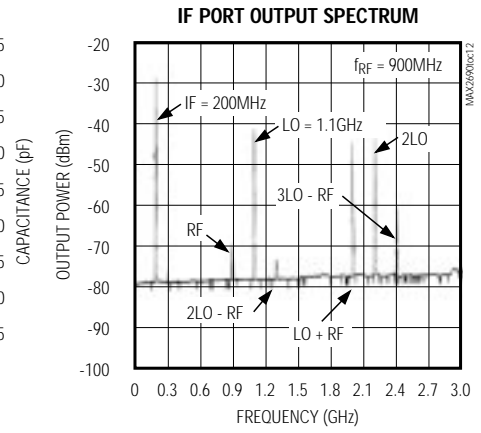
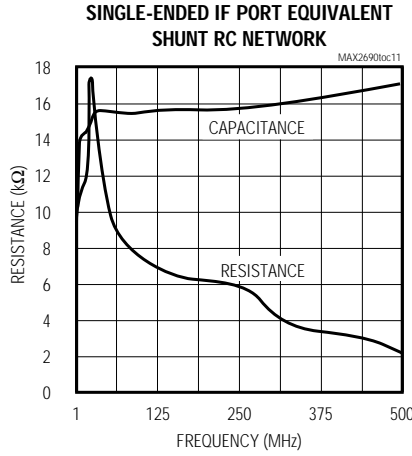
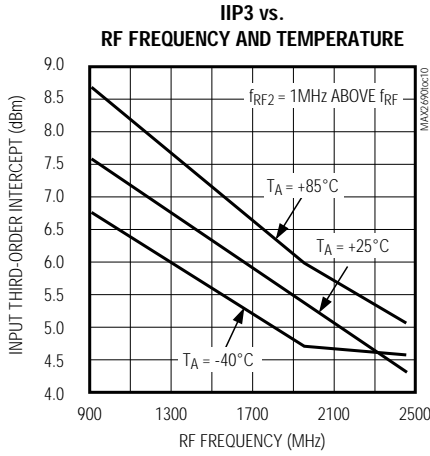

Low-Noise, 2.5GHz Downconverter Mixer

Key Specification Statistics

(MAX2690 EV kit, $V_{CC} = +3.0V$, $P_{LO} = -3dBm$, $P_{RF} = -25dBm$, $f_{RF} = 1.95GHz$, $f_{IF} = 200MHz$, $\overline{SHDN} = high$, $T_A = +25^{\circ}C$, unless otherwise noted.) Histograms represent measured data from a 30-unit sample taken from one wafer lot. The Gaussian curve is calculated for the measured data's mean and standard deviation and is scaled to account for process variations (the listed mean and standard deviation are from the scaled distribution, as plotted).

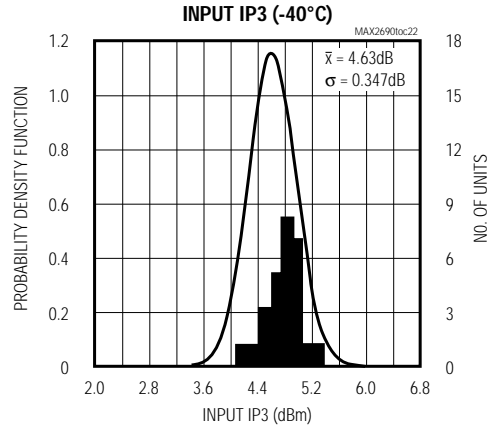
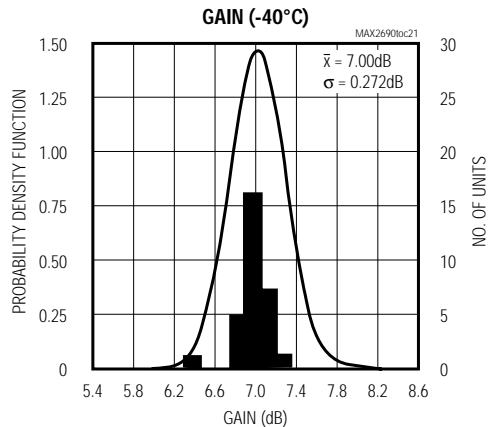
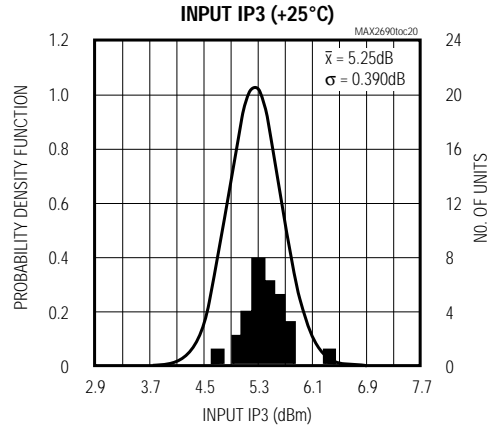
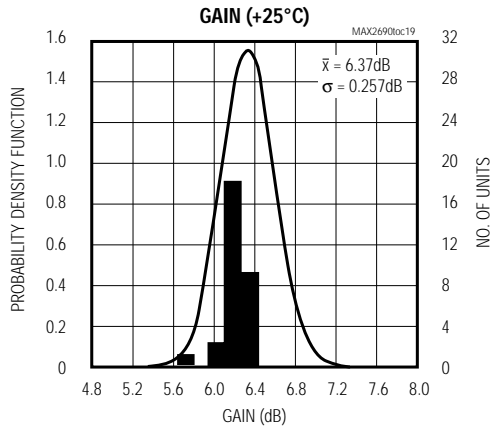
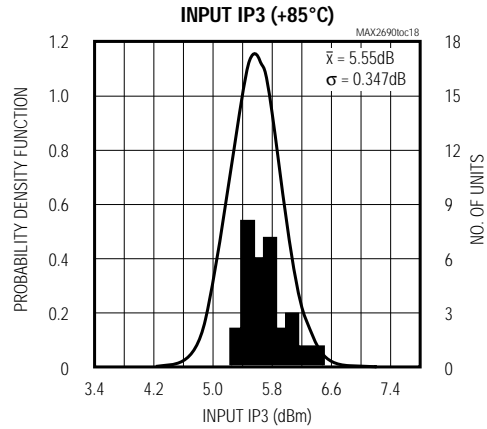
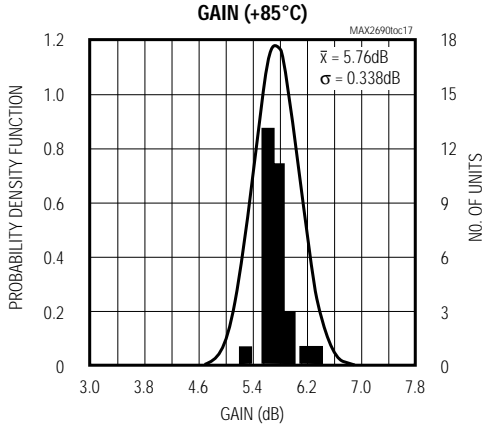

Low-Noise, 2.5GHz Downconverter Mixer

Pin Description

MAX2690

PIN	NAME	FUNCTION
1	LGND	Inductive Degeneration Pin. For maximum linearity, connect LGND directly to ground with no series inductance. Trade off linearity for gain by increasing the series inductance from LGND to ground. See the <i>Applications Information</i> section for more information.
2	GND	RF Ground. This pin must have a separate via to the ground plane, as close to the pin as possible to minimize inductance.
3	RFIN	RF Input Port. RF Input of Downconverter Mixer. See the <i>Applications Information</i> section for details on matching to RFIN.
4	RFBYP	RF Bypassing Capacitor Pin. Bypass RFBYP with an appropriate-value capacitor (typically 1000pF) to ground.
5	VCC	Supply-Voltage Input, +2.7V to +5.5V. Connect 0.1μF and 1000pF capacitors (in parallel) between VCC and GND.
6	LO	Local-Oscillator Input. LO should be AC coupled and presents a 50Ω load impedance. See the <i>Applications Information</i> section for more information.
7	GNDLO	Ground for the LO Port. This pin must have its own via to the ground plane, as close as possible to the pin to minimize inductance.
8	IFOUT-	Differential IF Inverting Output. IFOUT- is an open-collector output and must be pulled up to VCC with an external inductor for proper biasing. A resistor in parallel with the inductor may also be used to set a terminating impedance. See the <i>Typical Operating Characteristics</i> section for a plot of IF port characteristics vs. frequency (see plot titled Single-Ended IF Port Equivalent Shunt RC Network).
9	IFOUT+	Differential IF Noninverting Output. IFOUT+ is an open-collector output and must be pulled up to VCC with an external inductor for proper biasing. A resistor in parallel with the inductor may also be used to set a terminating impedance. See the <i>Typical Operating Characteristics</i> section for a plot of IF port characteristics vs. frequency (see plot titled Single-Ended IF Port Equivalent Shunt RC Network).
10	$\overline{\text{SHDN}}$	Active-Low Shutdown Input. A digital logic-low level at $\overline{\text{SHDN}}$ deactivates all part functions and reduces the supply current to typically 0.4μA.

Detailed Description

The MAX2690 is a 2.5GHz, double-balanced downconverter mixer designed to provide optimum intermodulation performance for a given supply current. It consists of a double-balanced Gilbert-cell mixer with single-ended RF and LO port connections, and a differential IF port. An on-chip bias cell provides a low-power shutdown feature.

RF Input

The RFIN and RFBYP pins form the MAX2690's RF input. The single-ended RF input signal is applied to the RFIN pin (refer to the RF Port Impedance vs. Frequency graph in the *Typical Operating Characteristics*). The RFBYP pin should be AC grounded typically with a 1000pF capacitor. This capacitor value should present a low impedance at both the RF and IF frequencies.

IF Output

The IFOUT+ and IFOUT- pins form the MAX2690's differential open-collector IF output. The IF output is coupled to the load using shunt inductors to VCC and series capacitors to the load. Most applications use a resistive termination of 500Ω (typical) resistors in parallel with the pull-up inductors to set a terminating impedance. The part's conversion gain has been specified with the resistors in place (using the output network on the MAX2690 EV kit), accounting for a 3dB loss due to the resistors. Therefore, it is possible to achieve an increase in gain with a properly designed matching network. However, the resistors provide for minimum passband ripple when this port is connected to typical IF filters.

Bias

The bias cell includes compensation circuitry to minimize conversion-gain variations over temperature as well as shutdown control circuitry. The $\overline{\text{SHDN}}$ pin can be used to disable all functions and reduce supply current to typically 0.4μA.

Low-Noise, 2.5GHz Downconverter Mixer

Applications Information

Local-Oscillator (LO) Input

The LO input is a single-ended broadband 50Ω input with a return loss of better than 10dB from 900MHz to 3GHz, improving at high frequency. For lower-frequency LO operation, a shunt resistor can be used to improve the LO port match (see the *Typical Operating Circuit* for more information). AC couple to LO. The LO signal is mixed with the input RF signal, and the resulting downconverted output appears on the IFOUT+ and IFOUT- pins.

RF Input

The typical RF input frequency range is 400MHz to 2.5GHz. For optimum performance, the RF input requires an impedance-matching network. Consult Table 1 as well as the RF Port Impedance vs. Frequency graph in the *Typical Operating Characteristics*.

Table 1. RF Input Impedance

PART	FREQUENCY		
	900MHz	1.95GHz	2.45GHz
Series Z	$45 - j 219\Omega$	$20 - j 110\Omega$	$18 - j 85\Omega$
Equivalent Shunt R	1100Ω	630Ω	400Ω
Equivalent Shunt C	0.7pF	0.7pF	0.7pF

IF Output

The IF output frequency range is typically 10MHz to 500MHz. The IFOUT+ and IFOUT- pins require external inductors to VCC for proper biasing. These outputs are high-impedance open collectors. In many applications, the biasing inductors have resistors in parallel with them to set an output impedance. Alternatively, a resistor between IFOUT+ and IFOUT- may be used. Consult the *Typical Operating Characteristics* section for more information.

For single-ended operation, the IFOUT- pin can be tied directly to VCC.

Power Supply and Bypassing

Proper attention to supply bypassing is essential for a high-frequency RF circuit. VCC (pin 5) must be properly bypassed with a $0.1\mu\text{F}$ capacitor in parallel with 1000pF to ground. Separate vias to the ground plane are needed for each of the bypass capacitors, as well as minimal trace length to reduce inductance. Each ground pin should have a separate via to the ground

plane. Low-inductance ground connections and controlled-impedance lines should be used in the layout.

To minimize noise on the internal bias cell, $\overline{\text{SHDN}}$ should be decoupled with a 1000pF capacitor to ground. A series resistor (typically 100Ω) can also be used to reduce high-frequency signals coupling into the $\overline{\text{SHDN}}$ pin.

Inductive Degeneration Pin (LGND)

A series inductor is typically connected from LGND to GND. Adjusting the value of this inductor allows the MAX2690 to be set to the optimum gain and linearity point for a particular application. A short from LGND to ground provides maximum linearity. Increasing the inductor value trades off linearity for gain. A large inductor provides maximum gain. See the *Typical Operating Characteristics* for a graph of conversion gain and linearity for several inductor values. The inductor's self-resonant frequency (SRF) should be as close as possible to or above the desired RF frequency for optimal performance.

Layout Issues

A well-designed PC board is an essential part of an RF circuit. For best performance, pay attention to power-supply issues as well as the layout of the RFIN matching network.

Power-Supply Layout

To minimize coupling between different sections of the IC, the ideal power-supply layout is a star configuration, which has a large decoupling capacitor at a central VCC node. The VCC traces branch out from this node, each going to a separate VCC node in the MAX2690 circuit. At the end of each of these traces is a bypass capacitor that is good at the RF frequency of interest. This arrangement provides local decoupling at each VCC pin. At high frequencies, any signal leaking out one supply pin sees a relatively high impedance (formed by the VCC trace inductance) to the central VCC node, and an even higher impedance to any other supply pin, as well as a low impedance to ground.

Matching-Network Layout

The layout of the RFIN matching network can be very sensitive to parasitic circuit elements. To minimize parasitic inductance, keep all traces short, and place components as close to the chip as possible. To minimize parasitic capacitance, a cut-out in the ground plane (and any other planes) below the matching network components can be used.

Low-Noise, 2.5GHz Downconverter Mixer

Typical Operating Circuit

MAX2690

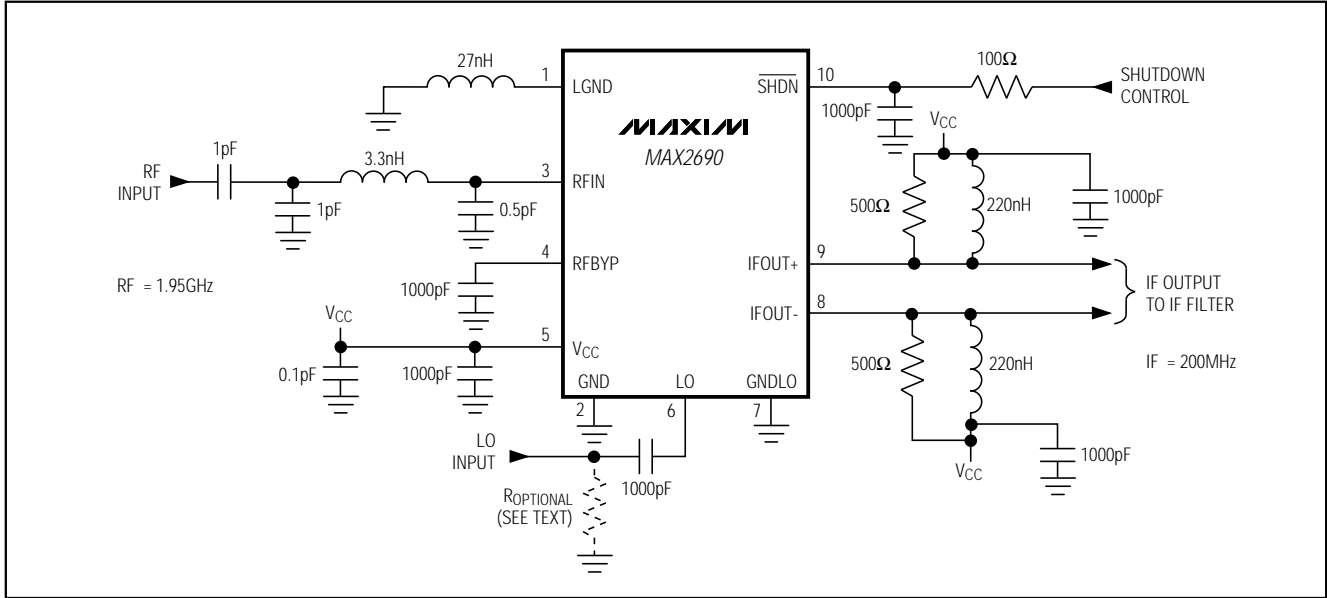

Low-Noise, 2.5GHz Downconverter Mixer

Package Information

T0LUMAXB.EPS

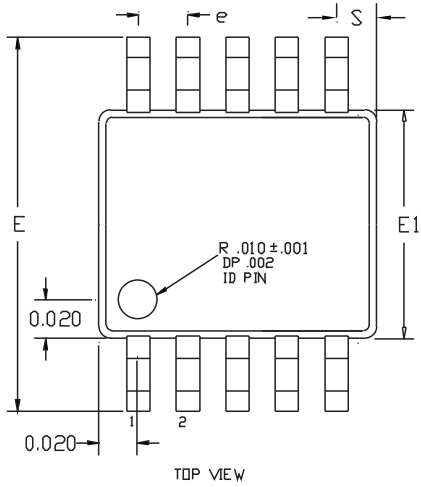

DIM	INCHES		MILLIMETERS	
	MIN	MAX	MIN	MAX
A	0.037	0.043	0.939	1.092
A1	0.002	0.006	0.051	0.152
A2	0.030	0.038	0.762	0.965
D1	0.112	0.124	2.845	3.150
D2	0.110	0.122	2.794	3.099
E1	0.112	0.124	2.845	3.150
E2	0.110	0.122	2.794	3.099
E	0.185	0.201	4.699	5.105
L	0.0155	0.0275	0.394	0.699
L1	0.037	REF	0.940	REF
b	0.007	0.0106	0.177	0.270
e	0.0197	BSC	.500	BSC
c	0.0035	0.0078	0.090	0.200
S	0.0196	REF	.498	REF
α	0°	6°	0°	6°

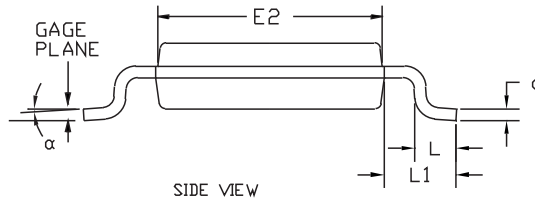
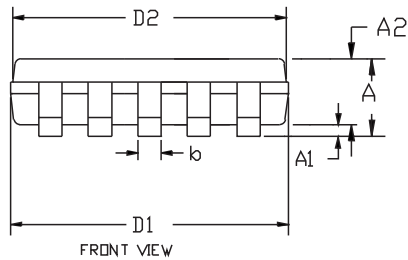

NOTES:

1. D&E DO NOT INCLUDE MOLD FLASH.
2. MOLD FLASH OR PROTRUSIONS NOT TO EXCEED .15mm(.006").
3. CONTROLLING DIMENSION: INCHES

MAXIM		
PROPRIETARY INFORMATION		
TITLE: PACKAGE OUTLINE, 10L MICRO MAX		
APPROVAL	DOCUMENT CONTROL NO. 21-0061	REV B 1/1