



# Advanced Chemistry-Independent, Level 2 Battery Charger with Input Current Limiting

MAX1645

## General Description

The MAX1645 is a high-efficiency battery charger capable of charging batteries of any chemistry type. It uses the Intel System Management Bus (SMBus™) to control voltage and current charge outputs.

When charging lithium-ion (Li+) batteries, the MAX1645 automatically transitions from regulating current to regulating voltage. The MAX1645 can also limit line input current so as not to exceed a predetermined current drawn from the DC source. A 175sec charge safety timer prevents "runaway charging" should the MAX1645 stop receiving charging voltage/current commands.

The MAX1645 employs a next-generation synchronous buck control circuitry that lowers the minimum input-to-output voltage drop by allowing the duty cycle to exceed 99%. The MAX1645 can easily charge one to four series Li+ cells.

## Applications

Notebook Computers  
Point-of-Sale Terminals  
Personal Digital Assistants

## Pin Configuration

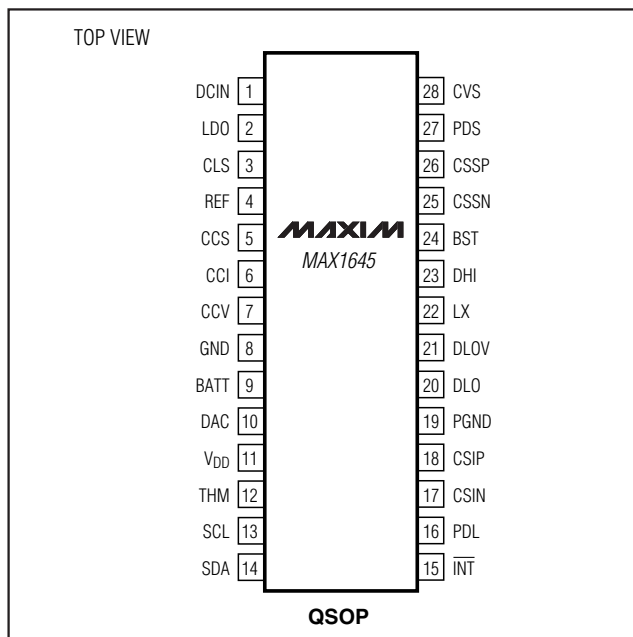

## Features

- ◆ Input Current Limiting
- ◆ 175sec Charge Safety Timeout
- ◆ 128mA Wake-Up Charge
- ◆ Charges Any Chemistry Battery:  
Li+, NiCd, NiMH, Lead Acid, etc.
- ◆ Intel SMBus 2-Wire Serial Interface
- ◆ Compliant with Level 2 Smart Battery Charger  
Spec. Rev. 1.0
- ◆ +8V to +28V Input Voltage Range
- ◆ Up to 18.4V Battery Voltage
- ◆ 11-Bit Battery Voltage Setting
- ◆ ±0.8% Output Voltage Accuracy with Internal  
Reference
- ◆ 3A max Battery Charge Current
- ◆ 6-Bit Charge Current Setting
- ◆ 99.99% max Duty Cycle for Low-Dropout Operation
- ◆ Load/Source Switchover Drivers
- ◆ >97% Efficiency

## Ordering Information

PART	TEMP. RANGE	PIN-PACKAGE
MAX1645EEI	-40°C to +85°C	28 QSOP

Typical Operating Circuit appears at end of data sheet.

SMBus is a trademark of Intel Corp.



Maxim Integrated Products 1

For free samples & the latest literature: <http://www.maxim-ic.com>, or phone 1-800-998-8800.  
For small orders, phone 1-800-835-8769.

# Advanced Chemistry-Independent, Level 2 Battery Charger with Input Current Limiting

## ABSOLUTE MAXIMUM RATINGS

DCIN, CVS, CSSP, CSSN, LX to GND .....-0.3V to +30V  
 CSSP to CSSN, CSIP to CSIN .....-0.3V to +0.3V  
 PDS, PDL to GND .....-0.3V to (V<sub>CS</sub>SP + 0.3V)  
 BST to LX.....-0.3V to +6V  
 DHI to LX.....-0.3V to (V<sub>BST</sub> + 0.3V)  
 CSIP, CSIN, BATT to GND .....-0.3V to +22V  
 LDO to GND .....-0.3V to (lower of 6V or V<sub>DCIN</sub> + 0.3V)  
 DLO to GND .....-0.3V to (V<sub>DLOV</sub> + 0.3V)  
 REF, DAC, CCV, CCI, CCS, CLS to GND.....-0.3V to (V<sub>LDO</sub> + 0.3V)

V<sub>DD</sub>, SCL, SDA, INT, DLOV to GND .....-0.3V to +6V  
 THM to GND .....-0.3V to (V<sub>DD</sub> + 0.3V)  
 PGND to GND .....-0.3V to +0.3V  
 LDO Continuous Current.....50mA  
 Continuous Power Dissipation (T<sub>A</sub> = +70°C)  
   28-Pin QSOP (derate 10.8mW/°C above +70°C).....860mW  
 Operating Temperature Range .....-40°C to +85°C  
 Storage Temperature.....-60°C to +150°C  
 Lead Temperature (soldering, 10sec).....+300°C

Stresses beyond those listed under "Absolute Maximum Ratings" may cause permanent damage to the device. These are stress ratings only, and functional operation of the device at these or any other conditions beyond those indicated in the operational sections of the specifications is not implied. Exposure to absolute maximum rating conditions for extended periods may affect device reliability.

## ELECTRICAL CHARACTERISTICS

(Circuit of Figure 1, V<sub>DD</sub> = +3.3V, V<sub>BATT</sub> = +16.8V, V<sub>DCIN</sub> = +18V, T<sub>A</sub> = 0°C to +85°C, unless otherwise noted. Typical values are at T<sub>A</sub> = +25°C.)

PARAMETER	SYMBOL	CONDITIONS	MIN	TYP	MAX	UNITS
<b>GENERAL SPECIFICATIONS</b>						
DCIN Typical Operating Range	V <sub>DCIN</sub>		8		28	V
DCIN Supply Current	I <sub>DCIN</sub>	8V < V <sub>DCIN</sub> < 28V		1.7	6	mA
DCIN Supply Current Charging Inhibited		8V < V <sub>DCIN</sub> < 28V		0.7	2	mA
DCIN Undervoltage Threshold		When AC_PRESENT switches	DCIN rising	7.5	7.85	V
			DCIN falling	7	7.4	
LDO Output Voltage	V <sub>LDO</sub>	8V < V <sub>DCIN</sub> < 28V, 0 < I <sub>LDO</sub> < 15mA	5.15	5.4	5.65	V
V <sub>DD</sub> Input Voltage Range (Note 1)		8V < V <sub>DCIN</sub> < 28V	2.8		5.65	V
V <sub>DD</sub> Undervoltage Threshold		When the SMB responds to commands	V <sub>DD</sub> rising	2.55	2.8	V
			V <sub>DD</sub> falling	2.1	2.5	
V <sub>DD</sub> Quiescent Current	I <sub>DD</sub>	0 < V <sub>DCIN</sub> < 6V, V <sub>DD</sub> = 5V, V <sub>SCL</sub> = 5V, V <sub>SDA</sub> = 5V		80	150	μA
REF Output Voltage	V <sub>REF</sub>	0 < I <sub>REF</sub> < 200μA	4.066	4.096	4.126	V
BATT Undervoltage Threshold (Note 2)		When I <sub>CHARGE</sub> drops to 128mA	2.4		2.8	V
PDS Charging Source Switch Turn-Off Threshold	V <sub>PDS-OFF</sub>	V <sub>CVS</sub> referred to V <sub>BATT</sub> , V <sub>CVS</sub> falling	50	100	150	mV
PDS Charging Source Switch Threshold Hysteresis	V <sub>PDS-HYS</sub>	V <sub>CVS</sub> referred to V <sub>BATT</sub>	100	200	300	mV
PDS Output Low Voltage, PDS Below CSSP		I <sub>PDS</sub> = 0	8	10	12	V
PDS Turn-On Current		PDS = CSSP	100	150	300	μA
PDS Turn-Off Current		V <sub>PDS</sub> = V <sub>CS</sub> SP - 2V, V <sub>DCIN</sub> = 16V	10	50		mA
PDL Load Switch Turn-Off Threshold	V <sub>PDL-OFF</sub>	V <sub>CVS</sub> referred to V <sub>BATT</sub> , V <sub>CVS</sub> rising	-150	-100	-50	mV

# Advanced Chemistry-Independent, Level 2 Battery Charger with Input Current Limiting

MAX1645

## ELECTRICAL CHARACTERISTICS (continued)

(Circuit of Figure 1,  $V_{DD} = +3.3V$ ,  $V_{BATT} = +16.8V$ ,  $V_{DCIN} = +18V$ ,  $T_A = 0^{\circ}C$  to  $+85^{\circ}C$ , unless otherwise noted. Typical values are at  $T_A = +25^{\circ}C$ .)

PARAMETER	SYMBOL	CONDITIONS	MIN	TYP	MAX	UNITS	
PDL Load Switch Threshold Hysteresis	$V_{PDL-HYS}$	$V_{CVS}$ referred to $V_{BATT}$	100	200	300	mV	
PDL Turn-Off Current		$V_{CSSN} - V_{PDL} = 1V$	6	12		mA	
PDL Turn-On Resistance		PDL to GND	50	100	150	k $\Omega$	
CVS Input Bias Current		$V_{CVS} = 28V$		6	20	$\mu A$	
BATT Full-Charge Voltage	$V_0$	ChargingVoltage() = 0x41A0	16.666	16.8	16.934	V	
		ChargingVoltage() = 0x3130	12.492	12.592	12.692		
		ChargingVoltage() = 0x20D0	8.333	8.4	8.467		
		Charging Voltage() = 0x1060	4.150	4.192	4.234		
BATT Charge Current (Note 3)	$I_0$	$R_{CS} = 50m\Omega$	ChargingCurrent() = 0x0BC0	2.798	3.008	3.218	A
			ChargingCurrent() = 0x0080	61.6	128	194.4	mA
DCIN Source Current Limit (Note 3)		$R_{CSS} = 40m\Omega$	$V_{CLS} = 4.096V$	4.714	5.12	5.526	A
			$V_{CLS} = 2.048V$	2.282	2.56	2.838	
BATT Undervoltage Charge Current		$V_{BATT} = 1V$ , $R_{CSI} = 50m\Omega$	20	128	200	mA	
BATT/CSIP/CSIN Input Voltage Range			0		20	V	
Total BATT Input Bias Current		Total of $I_{BATT}$ , $I_{CSIP}$ , and $I_{CSIN}$ ; $V_{BATT} = 0$ to 20V	-700		700	$\mu A$	
Total BATT Quiescent Current		Total of $I_{BATT}$ , $I_{CSIP}$ , and $I_{CSIN}$ ; $V_{BATT} = 0$ to 20V, charge inhibited	-100		100	$\mu A$	
Total BATT Standby Current		Total of $I_{BATT}$ , $I_{CSIP}$ , and $I_{CSIN}$ ; $V_{BATT} = 0$ to 20V, $V_{DCIN} = 0$	-5		5	$\mu A$	
CSSP Input Bias Current		$V_{CSSP} = V_{CSSN} = V_{DCIN} = 0$ to 28V	-100	540	1000	$\mu A$	
CSSN Input Bias Current		$V_{CSSP} = V_{CSSN} = V_{DCIN} = 0$ to 28V	-100	35	100	mA	
CSSP/CSSN Quiescent Current		$V_{CSSP} = V_{CSSN} = 28V$ , $V_{DCIN} = 0$	-1		1	$\mu A$	
Battery Voltage-Error Amp DC Gain		From BATT to CCV	200	500		V/V	
CLS Input Bias Current		$V_{CLS} = V_{REF}/2$ to $V_{REF}$	-1	0.05	1	$\mu A$	
Battery Voltage-Error Amp Transconductance		From BATT to CCV, ChargingVoltage() = 0x41A0, $V_{BATT} = 16.8V$	0.111	0.222	0.444	$\mu A/mV$	
Battery Current-Error Amp Transconductance		From CSIP/CSIN to CCI, ChargingCurrent() = 0x0BC0, $V_{CSIP} - V_{CSIN} = 150.4mV$	0.5	1	2	$\mu A/mV$	
Input Current-Error Amp Transconductance		From CSSP/CSSN to CCS, $V_{CLS} = 2.048V$ , $V_{CSSP} - V_{CSSN} = 102.4mV$	0.5	1	2	$\mu A/mV$	
CCV/CCI/CCS Clamp Voltage (Note 4)		$V_{CCV} = V_{CCI} = V_{CCS} = 0.25V$ to 2V	150	300	600	mV	

# Advanced Chemistry-Independent, Level 2 Battery Charger with Input Current Limiting

## ELECTRICAL CHARACTERISTICS (continued)

(Circuit of Figure 1,  $V_{DD} = +3.3V$ ,  $V_{BATT} = +16.8V$ ,  $V_{DCIN} = +18V$ ,  $T_A = 0^{\circ}C$  to  $+85^{\circ}C$ , unless otherwise noted. Typical values are at  $T_A = +25^{\circ}C$ .)

PARAMETER	SYMBOL	CONDITIONS	MIN	TYP	MAX	UNITS
<b>DC-TO-DC CONVERTER SPECIFICATIONS</b>						
Minimum Off-Time	$t_{OFF}$		1	1.25	1.5	$\mu s$
Maximum On-Time	$t_{ON}$		5	10	15	ms
Maximum Duty Cycle			99	99.99		%
LX Input Bias Current		$V_{DCIN} = 28V$ , $V_{BATT} = V_{LX} = 20V$		200	500	$\mu A$
LX Input Quiescent Current		$V_{DCIN} = 0$ , $V_{BATT} = V_{LX} = 20V$			1	$\mu A$
BST Supply Current		DHI high		6	15	$\mu A$
DLOV Supply Current		$V_{DLOV} = V_{LDO}$ , DLO low		5	10	$\mu A$
Inductor Peak Current Limit		$R_{CSI} = 50m\Omega$	5.0	6.0	7.0	A
DHI Output Resistance		DHI high or low, $V_{BST} - V_{LX} = 4.5V$		6	14	$\Omega$
DLO Output Resistance		DLO high or low, $V_{DLOV} = 4.5V$		6	14	$\Omega$
<b>THERMISTOR COMPARATOR SPECIFICATIONS</b>						
THM Input Bias Current		$V_{THM} = 4\%$ of $V_{DD}$ to $96\%$ of $V_{DD}$ , $V_{DD} = 2.8V$ to $5.65V$	-1		1	$\mu A$
Thermistor Overrange Threshold		$V_{DD} = 2.8V$ to $5.65V$ , $V_{THM}$ falling	89.5	91	92.5	% of $V_{DD}$
Thermistor Cold Threshold		$V_{DD} = 2.8V$ to $5.65V$ , $V_{THM}$ falling	74	75.5	77	% of $V_{DD}$
Thermistor Hot Threshold		$V_{DD} = 2.8V$ to $5.65V$ , $V_{THM}$ falling	22	23.5	25	% of $V_{DD}$
Thermistor Underrange Threshold		$V_{DD} = 2.8V$ to $5.65V$ , $V_{THM}$ falling	6	7.5	9	% of $V_{DD}$
Thermistor Comparator Threshold Hysteresis		All 4 comparators, $V_{DD} = 2.8V$ to $5.65V$		1		% of $V_{DD}$
<b>SMB INTERFACE LEVEL SPECIFICATIONS</b> ( $V_{DD} = 2.8V$ to $5.65V$ )						
SDA/SCL Input Low Voltage					0.6	V
SDA/SCL Input High Voltage			1.4			V
SDA/SCL Input Hysteresis				220		mV
SDA/SCL Input Bias Current			-1		1	$\mu A$
SDA Output Low Sink Current		$V_{SDA} = 0.4V$	6			mA
$\overline{INT}$ Output High Leakage		$V_{\overline{INT}} = 5.65V$			1	$\mu A$
$\overline{INT}$ Output Low Voltage		$I_{\overline{INT}} = 1mA$		25	200	mV
<b>SMB INTERFACE TIMING SPECIFICATIONS</b> ( $V_{DD} = 2.8V$ to $5.65V$ , Figures 4 and 5)						
SCL High Period	$t_{HIGH}$		4			$\mu s$
SCL Low Period	$t_{LOW}$		4.7			$\mu s$
Start Condition Setup Time from SCL	$t_{SU:STA}$		4.7			$\mu s$
Start Condition Hold Time from SCL	$t_{HD:STA}$		4			$\mu s$
SDA Setup Time from SCL	$t_{SU:DAT}$		250			ns
SDA Hold Time from SCL	$t_{HD:DAT}$		0			ns

# Advanced Chemistry-Independent, Level 2 Battery Charger with Input Current Limiting

**MAX1645**

## ELECTRICAL CHARACTERISTICS (continued)

(Circuit of Figure 1,  $V_{DD} = +3.3V$ ,  $V_{BATT} = +16.8V$ ,  $V_{DCIN} = +18V$ ,  $T_A = 0^{\circ}C$  to  $+85^{\circ}C$ , unless otherwise noted. Typical values are at  $T_A = +25^{\circ}C$ .)

PARAMETER	SYMBOL	CONDITIONS	MIN	TYP	MAX	UNITS
SDA Output Data Valid from SCL	$t_{DV}$				1	$\mu s$
Maximum Charge Period Without a Charging Voltage() or Charging Current() Loaded	$t_{WDT}$		140	175	210	sec

## ELECTRICAL CHARACTERISTICS

(Circuit of Figure 1,  $V_{DD} = +3.3V$ ,  $V_{BATT} = +16.8V$ ,  $V_{DCIN} = +18V$ ,  $T_A = -40^{\circ}C$  to  $+85^{\circ}C$ , unless otherwise noted. Guaranteed by design.)

PARAMETER	SYMBOL	CONDITIONS	MIN	MAX	UNITS
<b>GENERAL SPECIFICATIONS</b>					
DCIN Typical Operating Range	$V_{DCIN}$		8	28	V
DCIN Supply Current	$I_{DCIN}$	$8V < V_{DCIN} < 28V$		6	mA
DCIN Supply Current Charging Inhibited		$8V < V_{DCIN} < 28V$		2	mA
DCIN Undervoltage Threshold		When AC_PRESENT switches	DCIN rising	7.85	V
			DCIN falling	7	
LDO Output Voltage	$V_{LDO}$	$8V < V_{DCIN} < 28V$ , $0 < I_{LDO} < 15mA$	5.15	5.65	V
$V_{DD}$ Input Voltage Range (Note 1)		$8V < V_{DCIN} < 28V$	2.8	5.65	V
$V_{DD}$ Undervoltage Threshold		When the SMB responds to commands	$V_{DD}$ rising	2.8	V
			$V_{DD}$ falling	2.1	
$V_{DD}$ Quiescent Current	$I_{DD}$	$0 < V_{DCIN} < 6V$ , $V_{DD} = 5V$ , $V_{SCL} = 5V$ , $V_{SDA} = 5V$		150	$\mu A$
REF Output Voltage	$V_{REF}$	$0 < I_{REF} < 200\mu A$	4.035	4.157	V
BATT Undervoltage Threshold (Note 2)		When $I_{CHARGE}$ drops to 128mA	2.4	2.8	V
PDS Charging Source Switch Turn-Off Threshold	$V_{PDS-OFF}$	$V_{CVS}$ referred to $V_{BATT}$ , $V_{CVS}$ falling	50	150	mV
PDS Charging Source Switch Threshold Hysteresis	$V_{PDS-HYS}$	$V_{CVS}$ referred to $V_{BATT}$	100	300	mV
PDS Output Low Voltage, PDS Below CSSP		$I_{PDS} = 0$	8	12	V
PDS Turn-On Current		$PDS = CSSP$	100	300	$\mu A$
PDS Turn-Off Current		$V_{PDS} = V_{CSSP} - 2V$ , $V_{DCIN} = 16V$	10		mA
PDL Load Switch Turn-Off Threshold	$V_{PDL-OFF}$	$V_{CVS}$ referred to $V_{BATT}$ , $V_{CVS}$ rising	-150	-50	mV
PDL Load Switch Threshold Hysteresis	$V_{PDL-HYS}$	$V_{CVS}$ referred to $V_{BATT}$	100	300	mV
PDL Turn-Off Current		$V_{CSSN} - V_{PDL} = 1V$	6		mA

# Advanced Chemistry-Independent, Level 2 Battery Charger with Input Current Limiting

## ELECTRICAL CHARACTERISTICS (continued)

(Circuit of Figure 1,  $V_{DD} = +3.3V$ ,  $V_{BATT} = +16.8V$ ,  $V_{DCIN} = +18V$ ,  $T_A = -40^{\circ}C$  to  $+85^{\circ}C$ , unless otherwise noted. Guaranteed by design.)

PARAMETER	SYMBOL	CONDITIONS		MIN	MAX	UNITS
PDL Turn-On Resistance		PDL to GND		50	150	$k\Omega$
CVS Input Bias Current		$V_{CVS} = 28V$			20	$\mu A$
<b>ERROR AMPLIFIER SPECIFICATIONS</b>						
BATT Full-Charge Voltage	VO	ChargingVoltage() = 0x41A0		16.532	17.068	V
		ChargingVoltage() = 0x3130		12.391	12.793	
		ChargingVoltage() = 0x20D0		8.266	8.534	
		ChargingVoltage() = 0x1060		4.124	4.260	
BATT Charge Current (Note 3)	IO	$R_{CSI} = 50m\Omega$	ChargingCurrent() = 0x0BC0	2.608	3.408	A
			ChargingCurrent() = 0x0080	15.2	240.8	mA
DCIN Source Current Limit (Note 3)		$R_{CSS} = 40m\Omega$	$V_{CLS} = 4.096V$	4.358	5.882	A
			$V_{CLS} = 2.048V$	2.054	3.006	
BATT Undervoltage Charge Current		$V_{BATT} = 1V$ , $R_{CSI} = 50m\Omega$		20	200	mA
BATT/CSIP/CSIN Input Voltage Range				0	20	V
Total BATT Input Bias Current		Total of $I_{BATT}$ , $I_{CSIP}$ , and $I_{CSIN}$ ; $V_{BATT} = 0$ to $20V$		-700	700	$\mu A$
Total BATT Quiescent Current		Total of $I_{BATT}$ , $I_{CSIP}$ , and $I_{CSIN}$ ; $V_{BATT} = 0$ to $20V$ , charge inhibited		-100	100	$\mu A$
Total BATT Standby Current		Total of $I_{BATT}$ , $I_{CSIP}$ , and $I_{CSIN}$ ; $V_{BATT} = 0$ to $20V$ , $V_{DCIN} = 0$		-5	5	$\mu A$
CSSP/Input Bias Current		$V_{CSSP} = V_{CSSN} = V_{DCIN} = 28V$		-100	1000	$\mu A$
CSSN Input Bias Current		$V_{CSSP} = V_{CSSN} = V_{DCIN} = 28V$		-100	100	$\mu A$
CSSP/CSSN Quiescent Current		$V_{CSSP} = V_{CSSN} = 28V$ , $V_{DCIN} = 0$		-1	1	$\mu A$
Battery Voltage-Error Amp DC Gain		From BATT to CCV		200		V/V
CLS Input Bias Current		$V_{CLS} = V_{REF}/2$ to $V_{REF}$		-1	1	$\mu A$
Battery Voltage-Error Amp Transconductance		From BATT to CCV, ChargingVoltage() = 0x41A0, $V_{BATT} = 16.8V$		0.111	0.444	$\mu A/mV$
Battery Current-Error Amp Transconductance		From CSIP/CSIN to CCI, ChargingCurrent() = 0x0BC0, $V_{CSIP} - V_{CSIN} = 150.4mV$		0.5	2	$\mu A/mV$
Input Current-Error Amp Transconductance		From CSSP/CSSN to CCS, $V_{CLS} = 2.048V$ , $V_{CSSP} - V_{CSSN} = 102.4mV$		0.5	2	$\mu A/mV$
CCV/CCI/CCS Clamp Voltage (Note 4)		$V_{CCV} = V_{CCI} = V_{CCS} = 0.25V$ to $2V$		150	600	mV
<b>DC-TO-DC CONVERTER SPECIFICATIONS</b>						
Minimum Off-Time	$t_{OFF}$			1	1.5	$\mu s$
Maximum On-Time	$t_{ON}$			5	15	ms
Maximum Duty Cycle				99		%

# Advanced Chemistry-Independent, Level 2 Battery Charger with Input Current Limiting

MAX1645

## ELECTRICAL CHARACTERISTICS (continued)

(Circuit of Figure 1,  $V_{DD} = +3.3V$ ,  $V_{BATT} = +16.8V$ ,  $V_{DCIN} = +18V$ ,  $T_A = -40^{\circ}C$  to  $+85^{\circ}C$ , unless otherwise noted. Guaranteed by design.)

PARAMETER	SYMBOL	CONDITIONS	MIN	MAX	UNITS
LX Input Bias Current		$V_{DCIN} = 28V$ , $V_{BATT} = V_{LX} = 20V$		500	$\mu A$
LX Input Quiescent Current		$V_{DCIN} = 0$ , $V_{BATT} = V_{LX} = 20V$		1	$\mu A$
BST Supply Current		DHI high		15	$\mu A$
DLOV Supply Current		$V_{DLOV} = V_{LDO}$ , DLO low		10	$\mu A$
Inductor Peak Current Limit		$R_{CSI} = 50m\Omega$	5.0	7.0	A
DHI Output Resistance		DHI high or low, $V_{BST} - V_{LX} = 4.5V$		14	$\Omega$
DLO Output Resistance		DLO high or low, $V_{DLOV} = 4.5V$		14	$\Omega$
<b>THERMISTOR COMPARATOR SPECIFICATIONS</b>					
THM Input Bias Current		$V_{THM} = 4\%$ of $V_{DD}$ to $96\%$ of $V_{DD}$ , $V_{DD} = 2.8V$ to $5.65V$	-1	1	$\mu A$
Thermistor Overrange Threshold		$V_{DD} = 2.8V$ to $5.65V$ , $V_{THM}$ falling	89.5	92.5	% of $V_{DD}$
Thermistor Cold Threshold		$V_{DD} = 2.8V$ to $5.65V$ , $V_{THM}$ falling	74	77	% of $V_{DD}$
Thermistor Hot Threshold		$V_{DD} = 2.8V$ to $5.65V$ , $V_{THM}$ falling	22	25	% of $V_{DD}$
Thermistor Underrange Threshold		$V_{DD} = 2.8V$ to $5.65V$ , $V_{THM}$ falling	6	9	% of $V_{DD}$
<b>SMB INTERFACE LEVEL SPECIFICATIONS</b> ( $V_{DD} = 2.8V$ to $5.65V$ )					
SDA/SCL Input Low Voltage				0.6	V
SDA/SCL Input High Voltage			1.4		V
SDA/SCL Input Bias Current			-1	1	$\mu A$
SDA Output Low Sink Current		$V_{SDA} = 0.4V$	6		mA
$\overline{INT}$ Output High Leakage		$V_{\overline{INT}} = 5.65V$		1	$\mu A$
$\overline{INT}$ Output Low Voltage		$I_{\overline{INT}} = 1mA$		200	mV
<b>SMB INTERFACE TIMING SPECIFICATIONS</b> ( $V_{DD} = 2.8V$ to $5.65V$ , Figures 4 and 5)					
SCL High Period	$t_{HIGH}$		4		$\mu s$
SCL Low Period	$t_{LOW}$		4.7		$\mu s$
Start Condition Setup Time from SCL	$t_{SU:STA}$		4.7		$\mu s$
Start Condition Hold Time from SCL	$t_{HD:STA}$		4		$\mu s$
SDA Setup Time from SCL	$t_{SU:DAT}$		250		ns
SDA Hold Time from SCL	$t_{HD:DAT}$		0		ns

# Advanced Chemistry-Independent, Level 2 Battery Charger with Input Current Limiting

## ELECTRICAL CHARACTERISTICS (continued)

(Circuit of Figure 1,  $V_{DD} = +3.3V$ ,  $V_{BATT} = +16.8V$ ,  $V_{DCIN} = +18V$ ,  $T_A = -40^{\circ}C$  to  $+85^{\circ}C$ , unless otherwise noted. Guaranteed by design.)

PARAMETER	SYMBOL	CONDITIONS	MIN	MAX	UNITS
SDA Output Data Valid from SCL	$t_{DV}$			1	$\mu s$
Maximum Charge Period Without a Charging Voltage() or Charging Current() loaded	$t_{WDT}$		140	210	sec

**Note 1:** Guaranteed by meeting the SMB timing specs.

**Note 2:** The charger reverts to a trickle-charge mode of  $I_{CHARGE} = 128mA$  below this threshold.

**Note 3:** Does not include current-sense resistor tolerance.

**Note 4:** Voltage difference between CCV, and CCI or CCS when one of these three pins is held low and the others try to pull high.

## Typical Operating Characteristics

(Circuit of Figure 1,  $V_{DCIN} = 20V$ ,  $T_A = +25^{\circ}C$ , unless otherwise noted.)

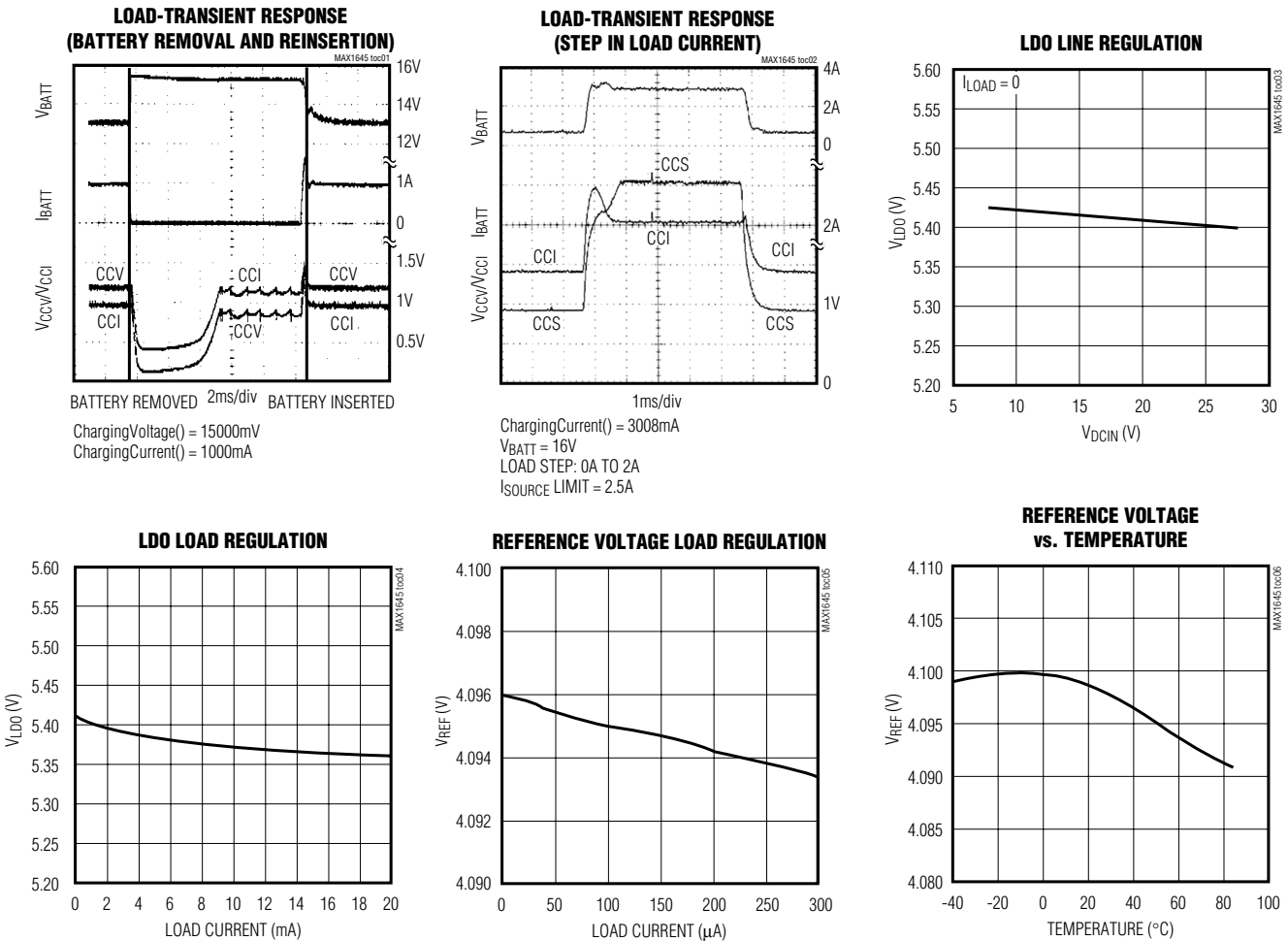



# Advanced Chemistry-Independent, Level 2 Battery Charger with Input Current Limiting

MAX1645

## Typical Operating Characteristics (continued)

(Circuit of Figure 1,  $V_{DCIN} = 20V$ ,  $T_A = +25^\circ C$ , unless otherwise noted.)

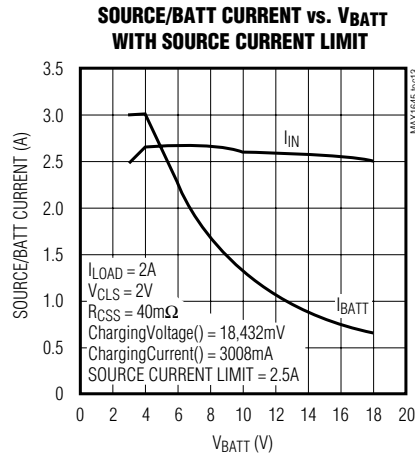
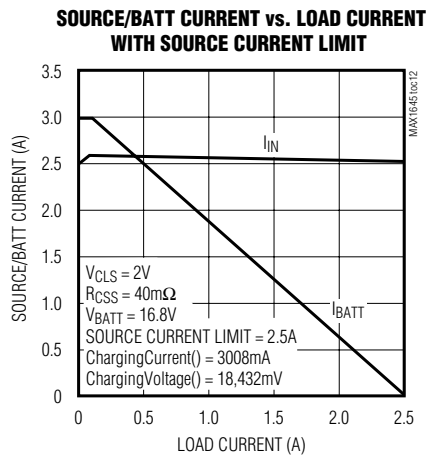
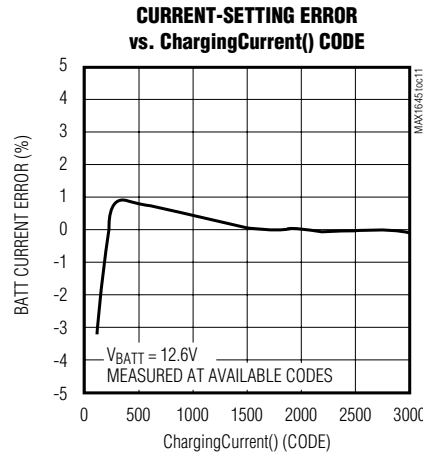
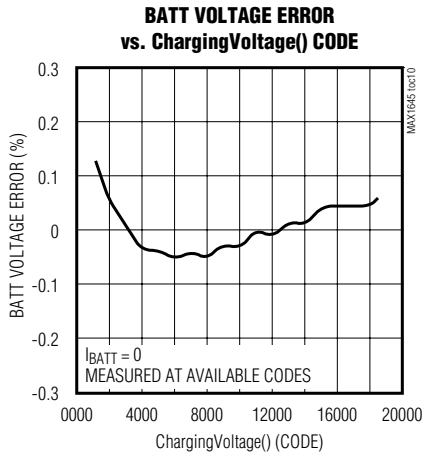
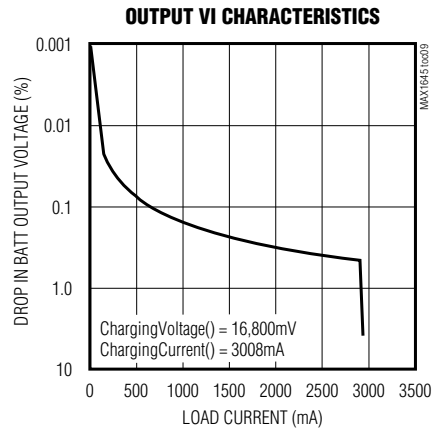
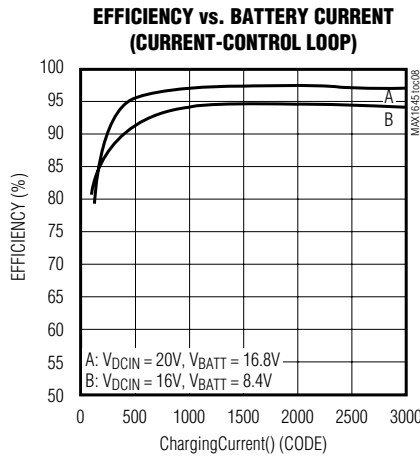
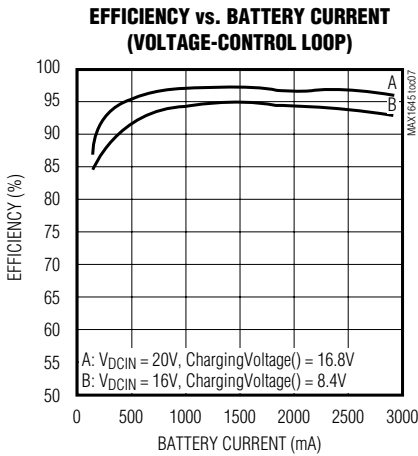

# Advanced Chemistry-Independent, Level 2 Battery Charger with Input Current Limiting

## Pin Description

PIN	NAME	FUNCTION
1	DCIN	DC Supply Voltage Input
2	LDO	5.4V Linear-Regulator Voltage Output. Bypass with a 1 $\mu$ F capacitor to GND.
3	CLS	Source Current Limit Input
4	REF	4.096V Reference Voltage Output
5	CCS	Charging Source Compensation Capacitor Connection. Connect a 0.01 $\mu$ F capacitor from CCS to GND.
6	CCI	Battery Current-Loop Compensation Capacitor Connection. Connect a 0.01 $\mu$ F capacitor from CCI to GND.
7	CCV	Battery Voltage-Loop Compensation Capacitor Connection. Connect a 10k $\Omega$ resistor in series with a 0.01 $\mu$ F capacitor to GND.
8	GND	Ground
9	BATT	Battery Voltage Output
10	DAC	DAC Voltage Output
11	V <sub>DD</sub>	Logic Circuitry Supply Voltage Input (2.8V to 5.65V)
12	THM	Thermistor Voltage Input
13	SCL	SMB Clock Input
14	SDA	SMB Data Input/Output. Open-drain output. Needs external pull-up.
15	$\overline{\text{INT}}$	Interrupt Output. Open-drain output. Needs external pull-up.
16	PDL	PMOS Load Switch Driver Output
17	CSIN	Battery Current-Sense Negative Input
18	CSIP	Battery Current-Sense Positive Input
19	PGND	Power Ground
20	DLO	Low-Side NMOS Driver Output
21	DLOV	Low-Side NMOS Driver Supply Voltage. Bypass with 0.1 $\mu$ F capacitor to GND.
22	LX	Inductor Voltage Sense Input
23	DHI	High-Side NMOS Driver Output
24	BST	High-Side Driver Bootstrap Voltage Input. Bypass with 0.1 $\mu$ F capacitor to LX.
25	CSSN	Charging Source Current-Sense Negative Input
26	CSSP	Charging Source Current-Sense Positive Input
27	PDS	Charging Source PMOS Switch Driver Output
28	CVS	Charging Source Voltage Input

# Advanced Chemistry-Independent, Level 2 Battery Charger with Input Current Limiting

## Detailed Description

The MAX1645 consists of current-sense amplifiers, an SMBus interface, transconductance amplifiers, reference circuitry, and a DC-DC converter (Figure 2). The DC-DC converter generates the control signals for the external MOSFETs to maintain the voltage and the current set by the SMBus interface. The MAX1645 features a voltage-regulation loop and two current-regulation loops. The loops operate independently of each other. The voltage-regulation loop monitors BATT to ensure that its voltage never exceeds the voltage set point (V<sub>0</sub>). The battery current-regulation loop monitors current delivered to BATT to ensure that it never exceeds the current-limit set point (I<sub>0</sub>). The battery current-regulation loop is in control as long as BATT voltage is below V<sub>0</sub>. When BATT voltage reaches V<sub>0</sub>, the current loop no longer regulates. A third loop reduces the battery-charging current when the sum of the system (the main load) and the battery charger input current exceeds the charging source current limit.

### Setting Output Voltage

The MAX1645's voltage DAC has a 16mV LSB and an 18.432V full scale. The SMBus specification allows for a 16-bit ChargingVoltage() command that translates to a 1mV LSB and a 65.535V full-scale voltage; therefore, the ChargingVoltage() value corresponds to the output voltage in millivolts. The MAX1645 ignores the first four LSBs and uses the next 11 LSBs to control the voltage DAC. All codes greater than or equal to 0b0100 1000 0000 0000 (18432mV) result in a voltage overrange, limiting the charger voltage to 18.432V. All codes below 0b0000 0100 0000 0000 (1024mV) terminate charging.

### Setting Output Current

The MAX1645's current DAC has a 64mA LSB and a 3.008A full scale. The SMBus specification allows for a 16-bit ChargingCurrent() command that translates to a 1mA LSB and a 65.535A full-scale current; the ChargingCurrent() value corresponds to the charging voltage in milliamperes. The MAX1645 drops the first six LSBs and uses the next six LSBs to control the current DAC. All codes above 0b00 1011 1100 0000 (3008mA) result in a current overrange, limiting the charger current to 3.008A. All codes below 0b0000 0000 1000 0000 (128mA) turn the charging current off. A 50mΩ sense resistor (R<sub>2</sub> in Figure 1) is required to achieve the correct CODE/current scaling.

### Input Current Limiting

The MAX1645 limits the current drawn by the charger when the load current becomes high. The device limits the charging current so the AC adapter voltage is not

loaded down. An internal amplifier compares the voltage between CSSP and CSSN to the voltage at CLS/20. V<sub>CLS</sub> is set by a resistor divider between REF and GND.

The input source current is the sum of the device current, the charge input current, and the load current. The device current is minimal (6mA max) in comparison to the charge and load currents. The charger input current is generated by the DC-DC converter; therefore, the actual source current required is determined as follows:

$$I_{SOURCE} = I_{LOAD} + [(I_{CHARGE} \cdot V_{BATT}) / (V_{IN} \cdot \eta)]$$

where  $\eta$  is the efficiency of the DC-DC converter (typically 85% to 95%).

V<sub>CLS</sub> determines the threshold voltage of the CSS comparator. R<sub>3</sub> and R<sub>4</sub> (Figure 1) set the voltage at CLS. Sense resistor R<sub>1</sub> sets the maximum allowable source current. Calculate the maximum current as follows:

$$I_{MAX} = V_{CLS} / (20 \cdot R_1)$$

(Limit V<sub>CSSP</sub> - V<sub>CSSN</sub> to between 102.4mV and 204.8mV.)

The configuration in Figure 1 provides an input current limit of:

$$I_{MAX} = (2.048V / 20) / 0.04\Omega = 2.56A$$

### LDO Regulator

The LDO provides a +5.4V supply derived from DCIN and can deliver up to 15mA of current. The LDO sets the gate-drive level of the NMOS switches in the DC-DC converter. The drivers are actually powered by DLOV and BST, which must be connected to LDO through a lowpass filter and a diode as shown in Figure 1. See also the *MOSFET Drivers* section. The LDO also supplies the 4.096V reference and most of the control circuitry. Bypass LDO with a 1μF capacitor.

### VDD Supply

This input provides power to the SMBus interface and the thermistor comparators. Typically connect V<sub>DD</sub> to LDO or, to keep the SMBus interface of the MAX1645 active while the supply to DCIN is removed, connect an external supply to V<sub>DD</sub>.

# Advanced Chemistry-Independent, Level 2 Battery Charger with Input Current Limiting

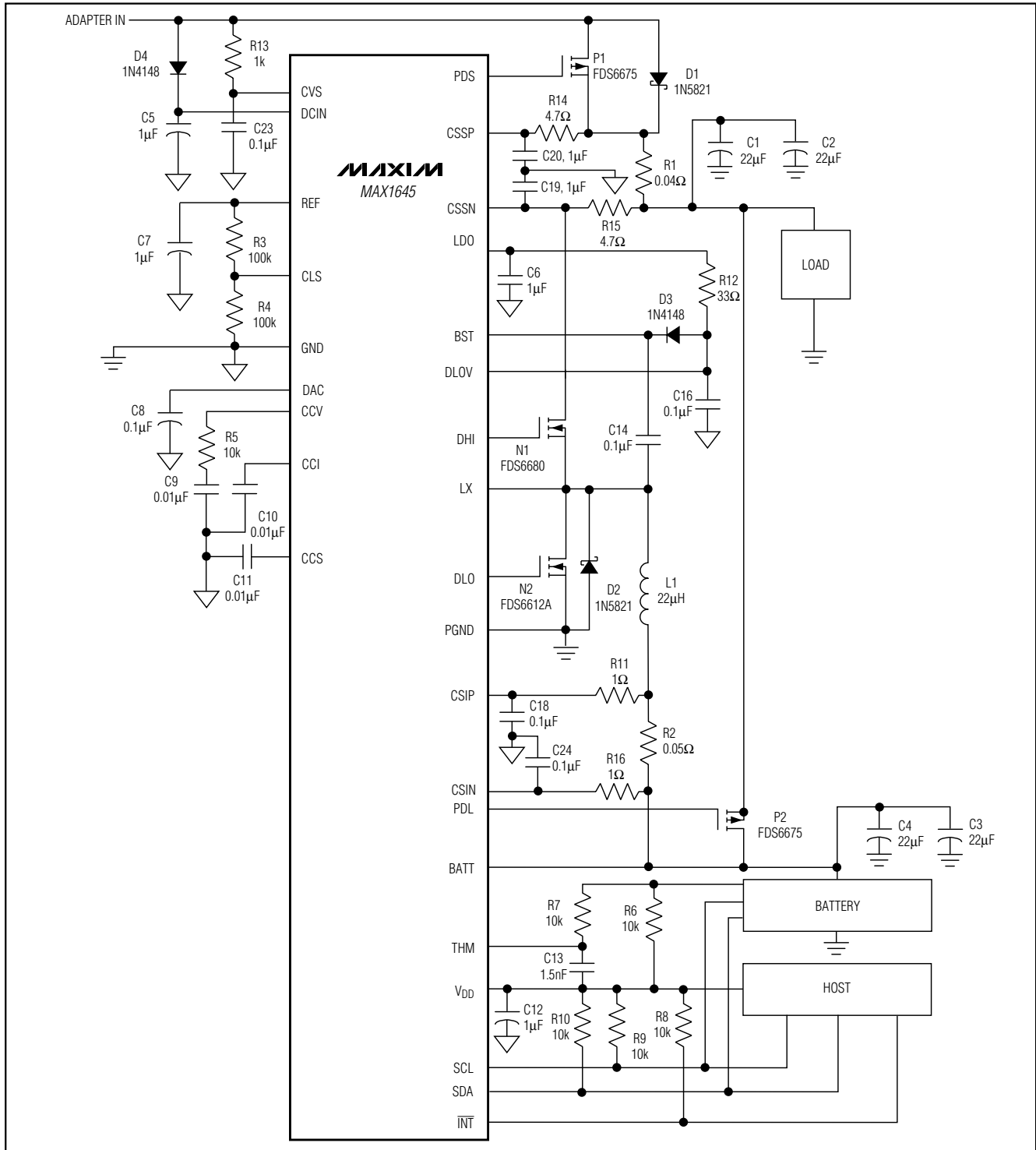

Figure 1. Typical Application Circuit



# Advanced Chemistry-Independent, Level 2 Battery Charger with Input Current Limiting

## Operating Conditions

The MAX1645 changes its operation depending on the voltages at DCIN, BATT, V<sub>DD</sub>, and THM. Several important operating states follow:

- **AC Present.** When DCIN is > 7.5V, the battery is considered to be in an AC Present state. In this condition, both the LDO and REF will function properly and battery charging is allowed. When AC is present, the AC\_PRESENT bit (bit 15) in the ChargerStatus() register is set to "1."
- **Power Fail.** When DCIN is < BATT + 0.3V, the MAX1645 is in the Power Fail state, since the charger doesn't have enough input voltage to charge the battery. In Power Fail, the PDS input PMOS switch is turned off and the POWER\_FAIL bit (bit 13) in the ChargerStatus() register is set to "1."
- **Battery Present.** When THM is < 91% of V<sub>DD</sub>, the battery is considered to be present. The MAX1645 uses the THM pin to detect when a battery is connected to the charger. When the battery is present, the BATTERY\_PRESENT bit (bit 14) in the ChargerStatus() register is set to "1" and charging can proceed. When the battery is not present, all of the MAX1645 registers are reset. With no battery present, the charger will still try to regulate the BATT pin voltage at 18.432V with 128mA of current compliance.
- **Battery Undervoltage.** When BATT < 2.5V, the battery is in an undervoltage state. This causes the charger to reduce its current compliance to 128mA. The content of the ChargingCurrent() register is unaffected and, when the BATT voltage exceeds 2.7V, normal charging resumes. ChargingVoltage() is unaffected and can be set as low as 1.024V.
- **V<sub>DD</sub> Undervoltage.** When V<sub>DD</sub> < 2.5V, the V<sub>DD</sub> supply is in an undervoltage state, and the SMBus interface will not respond to commands. Coming out of the undervoltage condition, MAX1645 will be in its Power-On Reset state. No charging will occur when V<sub>DD</sub> is under voltage.

## SMBus Interface

The MAX1645 receives control inputs from the SMBus interface. The serial interface complies with the SMBus specification (refer to the System Management Bus Specification from Intel Corporation). Charger functionality complies with the Intel/Duracell Smart Charger Specification for a Level 2 charger.

The MAX1645 uses the SMBus Read-Word and Write-Word protocols to communicate with the battery being charged, as well as with any host system that monitors the battery-to-charger communications as a Level 2 SMBus charger. The MAX1645 is an SMBus slave

device and does not initiate communication on the bus. It receives commands and responds to queries for status information. Figure 3 shows examples of the SMBus Write-Word and Read-Word protocols, and Figures 4 and 5 show the SMBus serial-interface timing.

Each communication with the MAX1645 begins with the MASTER issuing a START condition that is defined as a falling edge on SDA with SCL high and ends with a STOP condition defined as a rising edge on SDA with SCL high. Between the START and STOP conditions, the device address, the command byte, and the data bytes are sent. The MAX1645 device address is 0x12 and supports the charger commands as described in Tables 1–6.

## Battery Charger Commands

### ChargerSpecInfo()

The ChargerSpecInfo() command uses the Read-Word protocol (Figure 3b). The command code for ChargerSpecInfo() is 0x11 (0b00010001). Table 1 lists the functions of the data bits (D0–D15). Bit 0 refers to the D0 bit in the Read-Word protocol. The MAX1645 is version 1.0; therefore, the ChargerSpecInfo() command returns 0x01.

### ChargerMode()

The ChargerMode() command uses the Write-Word protocol (Figure 3a). The command code for ChargerMode() is 0x12 (0b00010010). Table 2 lists the functions of the data bits (D0–D15). Bit 0 refers to the D0 bit in the Write-Word protocol.

To charge a battery that has a thermistor impedance in the HOT range (i.e., THERMISTOR\_HOT = 1 and THERMISTOR\_UR = 0), the host must use the Charger Mode() command to clear HOT\_STOP after the battery is inserted. The HOT\_STOP bit returns to its default power-up condition ("1") whenever the battery is removed.

### ChargerStatus()

The ChargerStatus() command uses the Read-Word protocol (Figure 3b). The command code for Charger Status() is 0x13 (0b00010011). Table 3 describes the functions of the data bits (D0–D15). Bit 0 refers to the D0 bit in the Read-Word protocol.

The ChargerStatus() command returns information about thermistor impedance and the MAX1645's internal state. The latched bits, THERMISTOR\_HOT and ALARM\_INHIBITED, are cleared whenever BATTERY\_PRESENT = 0 or ChargerMode() is written with POR\_RESET = 1. The ALARM\_INHIBITED status bit can also be cleared by writing a new charging current OR charging voltage.

# Advanced Chemistry-Independent, Level 2 Battery Charger with Input Current Limiting

MAX1645

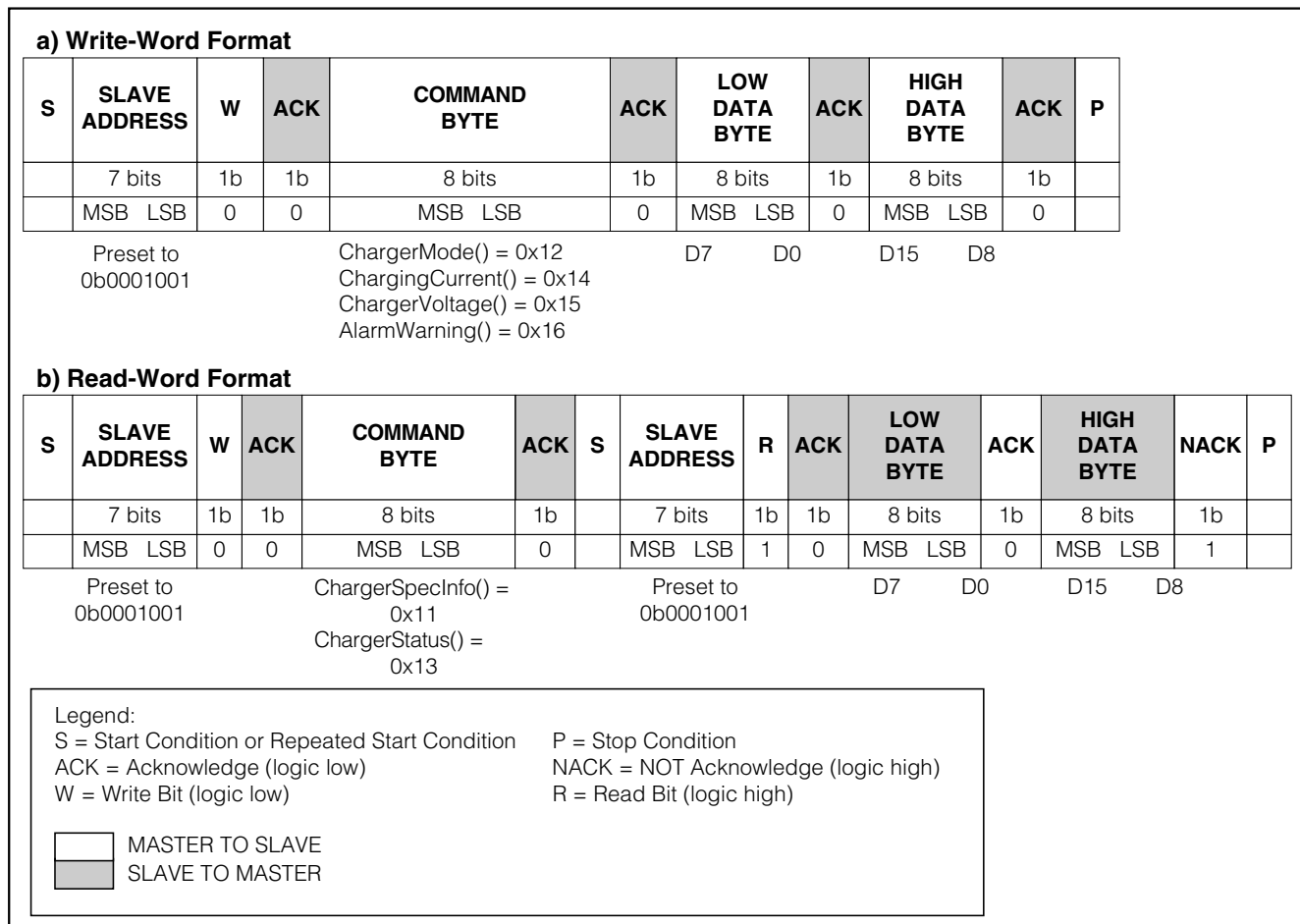

Figure 3. SMBus a) Write-Word and b) Read-Word Protocols

# Advanced Chemistry-Independent, Level 2 Battery Charger with Input Current Limiting

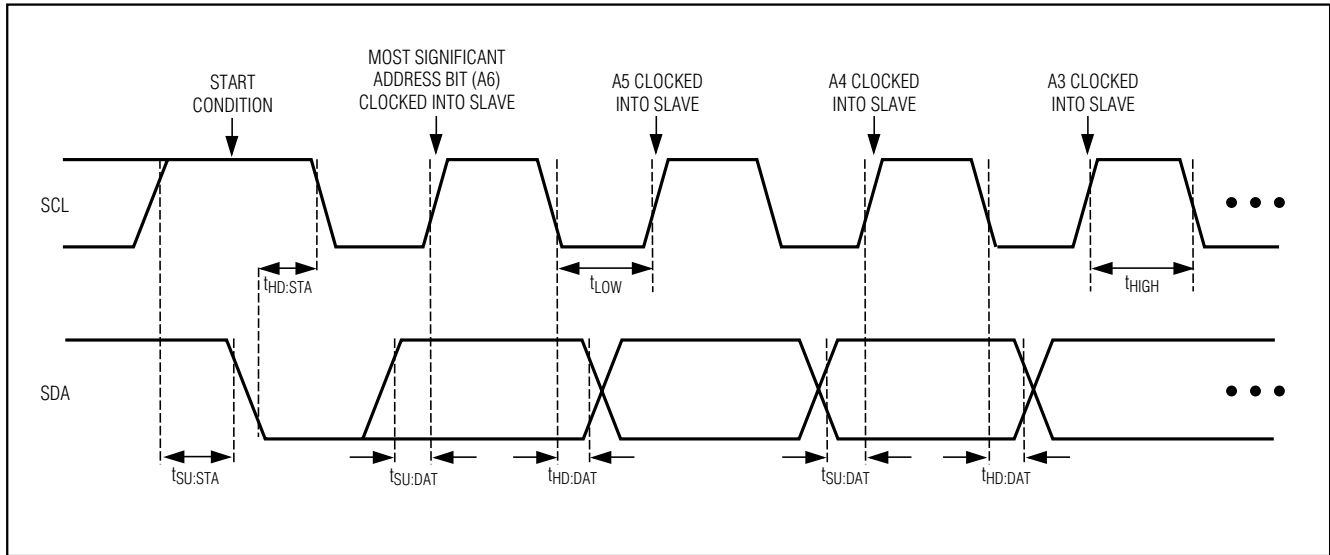

Figure 4. SMBus Serial Interface Timing—Address

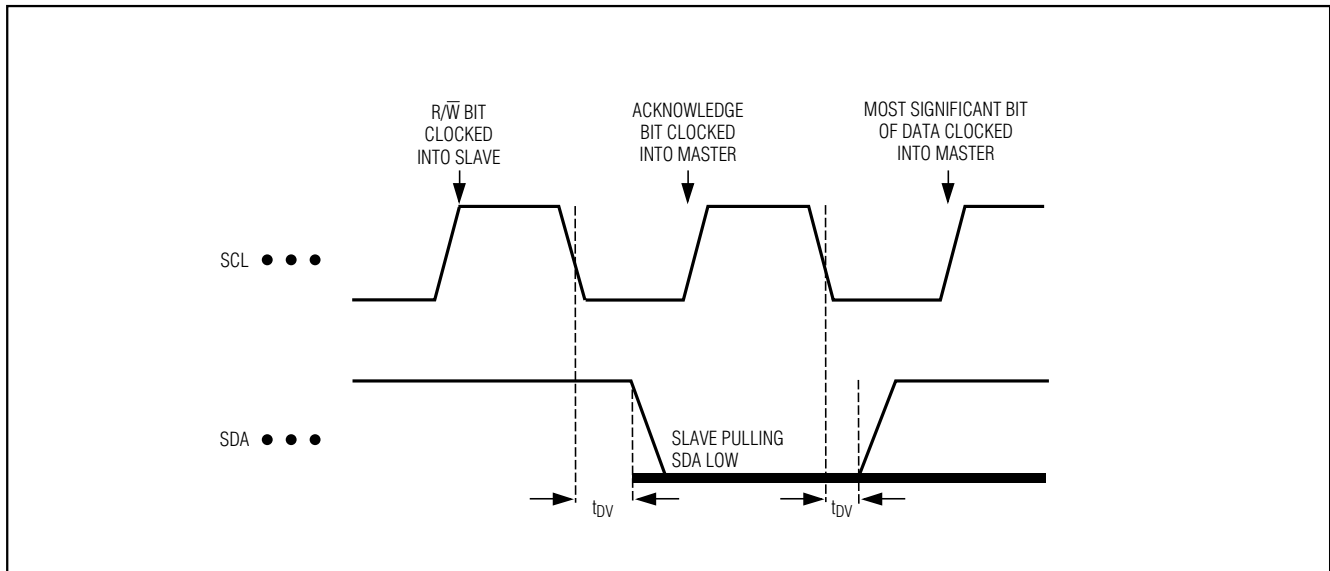

Figure 5. SMBus Serial Interface Timing—Acknowledgment



# Advanced Chemistry-Independent, Level 2 Battery Charger with Input Current Limiting

MAX1645

Table 1. ChargerSpecInfo()

BIT	NAME	DESCRIPTION
0	CHARGER_SPEC	Returns a "1" for Version 1.0
1	CHARGER_SPEC	Returns a "0" for Version 1.0
2	CHARGER_SPEC	Returns a "0" for Version 1.0
3	CHARGER_SPEC	Returns a "0" for Version 1.0
4	SELECTOR_SUPPORT	Returns a "0," indicating no smart battery selector functionality
5	Reserved	Returns a "0"
6	Reserved	Returns a "0"
7	Reserved	Returns a "0"
8	Reserved	Returns a "0"
9	Reserved	Returns a "0"
10	Reserved	Returns a "0"
11	Reserved	Returns a "0"
12	Reserved	Returns a "0"
13	Reserved	Returns a "0"
14	Reserved	Returns a "0"
15	Reserved	Returns a "0"

Command: 0x11

## Advanced Chemistry-Independent, Level 2 Battery Charger with Input Current Limiting

Table 2. ChargerMode()

BIT	NAME	DESCRIPTION
0	INHIBIT_CHARGE	0* = Allow normal operation; clear the CHG_INHIBITED flip-flop. 1 = Turn off the charger; set the CHG_INHIBITED flip-flop. The CHG_INHIBITED flip-flop is not affected by any other commands.
1	ENABLE_POLLING	Not implemented
2	POR_RESET	0 = No change. 1 = Change the ChargingVoltage() to 0xFFFF and the ChargingCurrent() to 0x00C0; clear the THERMISTOR_HOT and ALARM_INHIBITED flip-flops.
3	RESET_TO_ZERO	Not implemented
4	AC_PRESENT_MASK	0* = Interrupt on either edge of the AC_PRESENT status bit. 1 = Do not interrupt because of an AC_PRESENT bit change.
5	BATTERY_PRESENT_MASK	0* = Interrupt on either edge of the BATTERY_PRESENT status bit. 1 = Do not interrupt because of a BATTERY_PRESENT bit change.
6	POWER_FAIL_MASK	0* = Interrupt on either edge of the POWER_FAIL status bit. 1 = Do not interrupt because of a POWER_FAIL bit change.
7		Not implemented
8		Not implemented
9		Not implemented
10	HOT_STOP	0 = The THERMISTOR_HOT status bit does not turn off the charger. 1* = The THERMISTOR_HOT status bit does turn off the charger. THERMISTOR_HOT is reset by either POR_RESET or BATTERY_PRESENT = 0 status bit.
11		Not implemented
12		Not implemented
13		Not implemented
14		Not implemented
15		Not implemented

Command: 0x12

\*State at chip initial power-on (i.e.,  $V_{DD}$  from 0 to +3.3V)

# Advanced Chemistry-Independent, Level 2 Battery Charger with Input Current Limiting

**Table 3. ChargerStatus()**

BIT	NAME	FUNCTION
0	CHARGE_INHIBITED	0* = Ready to charge Smart Battery. 1 = Charger is inhibited, I(chg) = 0mA. This status bit returns the value of the CHG_INHIBITED flip-flop.
1	MASTER_MODE	Always returns "0"
2	VOLTAGE_NOT_REG	0 = Battery voltage is limited at the set point. 1 = Battery voltage is less than the set point.
3	CURRENT_NOT_REG	0 = Battery current is limited at the set point. 1 = Battery current is less than the set point.
4	LEVEL_2	Always returns a "1"
5	LEVEL_3	Always returns a "0"
6	CURRENT_OR	0* = The ChargingCurrent() value is valid for the MAX1645. 1 = The ChargingCurrent() value exceeds the MAX1645 output range, i.e., programmed ChargingCurrent() exceeds 3008mA.
7	VOLTAGE_OR	0 = The ChargingVoltage() value is valid for the MAX1645. 1* = The ChargingVoltage() value exceeds the MAX1645 output range, i.e., programmed ChargingVoltage() exceeds 1843mV.
8	THERMISTOR_OR	0 = THM is < 91% of the reference voltage. 1 = THM is > 91% of the reference voltage.
9	THERMISTOR_COLD	0 = THM is < 75.5% of the reference voltage. 1 = THM is > 75.5% of the reference voltage.
10	THERMISTOR_HOT	0 = THM has not dropped to < 23.5% of the reference voltage. 1 = THM has dropped to < 23.5% of the reference voltage. THERMISTOR_HOT flip-flop cleared by BATTERY_PRESENT = 0 or writing a "1" into the POR_RESET bit in the ChargerMode() command.
11	THERMISTOR_UR	0 = THM is > 7.5% of the reference voltage. 1 = THM is < 7.5% of the reference voltage.
12	ALARM_INHIBITED	Returns the state of the ALARM_INHIBITED flip-flop. This flip-flop is set by either a watchdog timeout or by writing an AlarmWarning() command with bits 11, 12, 13, 14, or 15 set. This flip-flop is cleared by BATTERY_PRESENT = 0, writing a "1" into the POR_RESET bit in the ChargerMode() command, or by receiving successive ChargingVoltage() and ChargingCurrent() commands. POR: 0.
13	POWER_FAIL	0 = The charging source voltage CVS is above the BATT voltage. 1 = The charging source voltage CVS is below the BATT voltage.
14	BATTERY_PRESENT	0 = No battery is present (based on THM input). 1 = Battery is present (based on THM input).
15	AC_PRESENT	0 = DCIN is below the 7.5V undervoltage threshold. 1 = DCIN is above the 7.5V undervoltage threshold.

Command: 0x13

\*State at chip initial power-on.

## Advanced Chemistry-Independent, Level 2 Battery Charger with Input Current Limiting

Table 4. ChargerCurrent()

BIT	NAME	FUNCTION
0		Not used. Normally a 1mA weight.
1		Not used. Normally a 2mA weight.
2		Not used. Normally a 4mA weight.
3		Not used. Normally an 8mA weight.
4		Not used. Normally a 16mA weight.
5		Not used. Normally a 32mA weight.
6	Charge Current, DACI 0	0 = Adds 0mA of charger-current compliance. 1 = Adds 64mA of charger-current compliance, 128mA min.
7	Charge Current, DACI 1	0 = Adds 0mA of charger-current compliance. 1 = Adds 128mA of charger-current compliance.
8	Charge Current, DACI 2	0 = Adds 0mA of charger-current compliance. 1 = Adds 256mA of charger-current compliance.
9	Charge Current, DACI 3	0 = Adds 0mA of charger-current compliance. 1 = Adds 512mA of charger-current compliance.
10	Charge Current, DACI 4	0 = Adds 0mA of charger-current compliance. 1 = Adds 1024mA of charger-current compliance.
11	Charge Current, DACI 5	0 = Adds 0mA of charger-current compliance. 1 = Adds 2048mA of charger-current compliance, 3008mA max.
12–15		0 = Adds 0mA of charger current compliance. 1 = Sets charger compliance into overrange, 3008mA.

Command: 0x14

# Advanced Chemistry-Independent, Level 2 Battery Charger with Input Current Limiting

MAX1645

Table 5. ChargingVoltage()

PIN	BIT NAME	FUNCTION
0		Not used. Normally a 1mV weight.
1		Not used. Normally a 2mV weight.
2		Not used. Normally a 4mV weight.
3		Not used. Normally an 8mV weight.
4	Charge Voltage, DACV 0	0 = Adds 0mV of charger-voltage compliance. 1 = Adds 16mV of charger-voltage compliance, 1.024V min.
5	Charge Voltage, DACV 1	0 = Adds 0mV of charger-voltage compliance. 1 = Adds 32mV of charger-voltage compliance, 1.024V min.
6	Charge Voltage, DACV 2	0 = Adds 0mV of charger-voltage compliance. 1 = Adds 64mV of charger-voltage compliance, 1.024V min.
7	Charge Voltage, DACV 3	0 = Adds 0mV of charger-voltage compliance. 1 = Adds 128mV of charger-voltage compliance, 1.024V min.
8	Charge Voltage, DACV 4	0 = Adds 0mV of charger-voltage compliance. 1 = Adds 256mV of charger-voltage compliance, 1.024V min.
9	Charge Voltage, DACV 5	0 = Adds 0mV of charger-voltage compliance. 1 = Adds 512mV of charger-voltage compliance, 1.024V min.
10	Charge Voltage, DACV 6	0 = Adds 0mA of charger-voltage compliance. 1 = Adds 1024mV of charger-voltage compliance.
11	Charge Voltage, DACV 7	0 = Adds 0mV of charger-voltage compliance. 1 = Adds 2048mV of charger-voltage compliance.
12	Charge Voltage, DACV 8	0 = Adds 0mV of charger-voltage compliance. 1 = Adds 4096mV of charger-voltage compliance.
13	Charge Voltage, DACV 9	0 = Adds 0mV of charger-voltage compliance. 1 = Adds 8192mV of charger-voltage compliance.
14	Charge Voltage, DACV 10	0 = Adds 0mV of charger-voltage compliance. 1 = Adds 16384mV of charger-voltage compliance, 18432mV max.
15	Charge Voltage, Overrange	0 = Adds 0mV of charger-voltage compliance. 1 = Sets charger compliance into overrange, 18432mV.

Command: 0x15

## Advanced Chemistry-Independent, Level 2 Battery Charger with Input Current Limiting

Table 6. AlarmWarning()

BIT	BIT NAME	DESCRIPTION
0	Error Code	Not used
1	Error Code	Not used
2	Error Code	Not used
3	Error Code	Not used
4	FULLY_DISCHARGED	Not used
5	FULLY_CHARGED	Not used
6	DISCHARGING	Not used
7	INITIALIZING	Not used
8	REMAINING_TIME_ALARM	Not used
9	REMAINING_CAPACITY_ALARM	Not used
10	Reserved	Not used
11	TERMINATE_DISCHARGE_ALARM	0 = Charge normally 1 = Terminate charging
12	OVER_TEMP_ALARM	0 = Charge normally 1 = Terminate charging
13	OTHER_ALARM	0 = Charge normally 1 = Terminate charging
14	TERMINATE_CHARGE_ALARM	0 = Charge normally 1 = Terminate charging
15	OVER_CHARGE_ALARM	0 = Charge normally 1 = Terminate charging

Command: 0x16

# Advanced Chemistry-Independent, Level 2 Battery Charger with Input Current Limiting

## ChargingCurrent() (POR: 0x0080)

The ChargingCurrent() command uses the Write-Word protocol (Figure 3a). The command code for ChargingCurrent() is 0x14 (0b00010100). The 16-bit binary number formed by D15–D0 represents the current-limit set point (I0) in milliamps. However, since the MAX1645 has 64mA resolution in setting I0, the D0–D5 bits are ignored as shown in Table 4. Figure 6 shows the mapping between I0 (the current-regulation-loop set point) and the ChargingCurrent() code. All codes above 0b00 1011 1100 0000 (3008mA) result in a current overrange, limiting the charger current to 3.008A. All codes below 0b0000 0000 1000 0000 (128mA) turn the charging current off. A 50mΩ sense resistor (R2 in Figure 1) is required to achieve the correct CODE/current scaling.

The power-on reset value for the ChargingCurrent() register is 0x0080; thus, the first time a MAX1645 is powered on, the BATT current regulates to 128mA. Any time the battery is removed, the ChargingCurrent() register returns to its power-on reset state.

## ChargingVoltage() (POR: 0x4800)

The ChargingVoltage() command uses the Write-Word protocol (Figure 3a). The command code for ChargingVoltage() is 0x15 (0b00010101). The 16-bit binary number formed by D15–D0 represents the voltage set point (V0) in millivolts; however, since the MAX1645 has 16mV resolution in setting V0, the D0, D1, D2, and D3 bits are ignored as shown in Table 5.

The ChargingVoltage command is used to set the battery charging voltage compliance from 1.024V to 18.432V. All codes greater than or equal to 0b0100 1000 0000 0000 (18432mV) result in a voltage overrange, limiting the charger voltage to 18.432V. All codes below 0b0000 0100 0000 0000 (1024mV) terminate charge. Figure 7 shows the mapping between V0 (the voltage-regulation-loop set point) and the ChargingVoltage() code.

The power-on reset value for the ChargingVoltage() register is 0x4880; thus, the first time a MAX1645 is powered on, the BATT voltage regulates to 18.432V. Any time the battery is removed, the ChargingVoltage() register returns to its power-on reset state. The voltage at DAC corresponds to the set compliance voltage divided by 4.5.

## AlarmWarning() (POR: Not Alarm)

The AlarmWarning() command uses the Write-Word protocol (Figure 3a). The command code for AlarmWarning() is 0x16 (0b00010110). AlarmWarning() sets the ALARM\_INHIBITED status bit in the MAX1645 if D15, D14, D13, D12, or D11 of the Write-Word protocol data equals 1. Table 6 summarizes the Alarm-

Warning() command's function. The ALARM\_INHIBITED status bit remains set until the battery is removed, a ChargerMode() command is written with the POR\_RESET bit set, or new ChargingCurrent() AND ChargingVoltage() values are written. As long as ALARM\_INHIBITED = 1, the MAX1645 switching regulator remains off.

## Interrupts and Alert Response Address

The MAX1645 requests an interrupt by pulling the INT pin low. An interrupt is normally requested when there is a change in the state of the ChargerStatus() bits POWER\_FAIL (bit 13), BATTERY\_PRESENT (bit 14), or AC\_PRESENT (bit 15). Therefore, the INT pin will pull low whenever the AC adapter is connected or disconnected, the battery is inserted or removed, or the charger goes in or out of dropout. The interrupts from each of the ChargerStatus() bits can be masked by an associated ChargerMode() bit POWER\_FAIL\_MASK (bit 6), BATTERY\_PRESENT\_MASK (bit 5), or AC\_PRESENT\_MASK (bit 4).

All interrupts are cleared by sending any command to the MAX1645, or by sending a command to the AlertResponse() address, 0x19, using a modified Receive Byte protocol. In this protocol, all devices that set an interrupt will try to respond by transmitting their address, and the device with the highest priority, or most leading 0's, will be recognized and cleared. The process will be repeated until all devices requesting interrupts are addressed and cleared. The MAX1645 responds to the AlertResponse() address with 0x13, which is its address and a trailing "1."

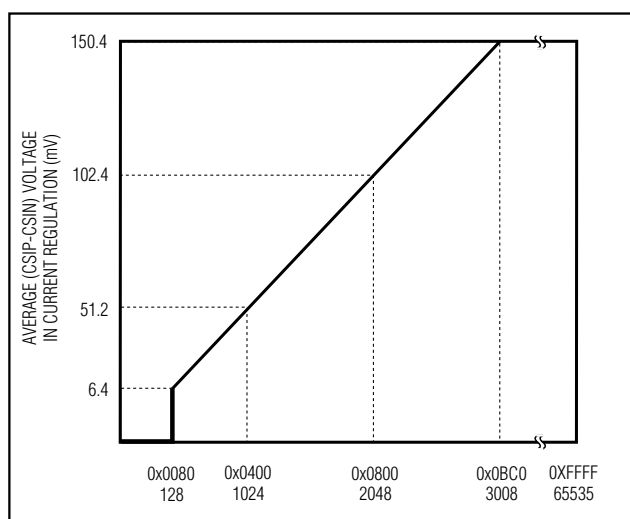

Figure 6. Average Voltage Between CSIP and CSIN vs. Charging Current() Code

# Advanced Chemistry-Independent, Level 2 Battery Charger with Input Current Limiting

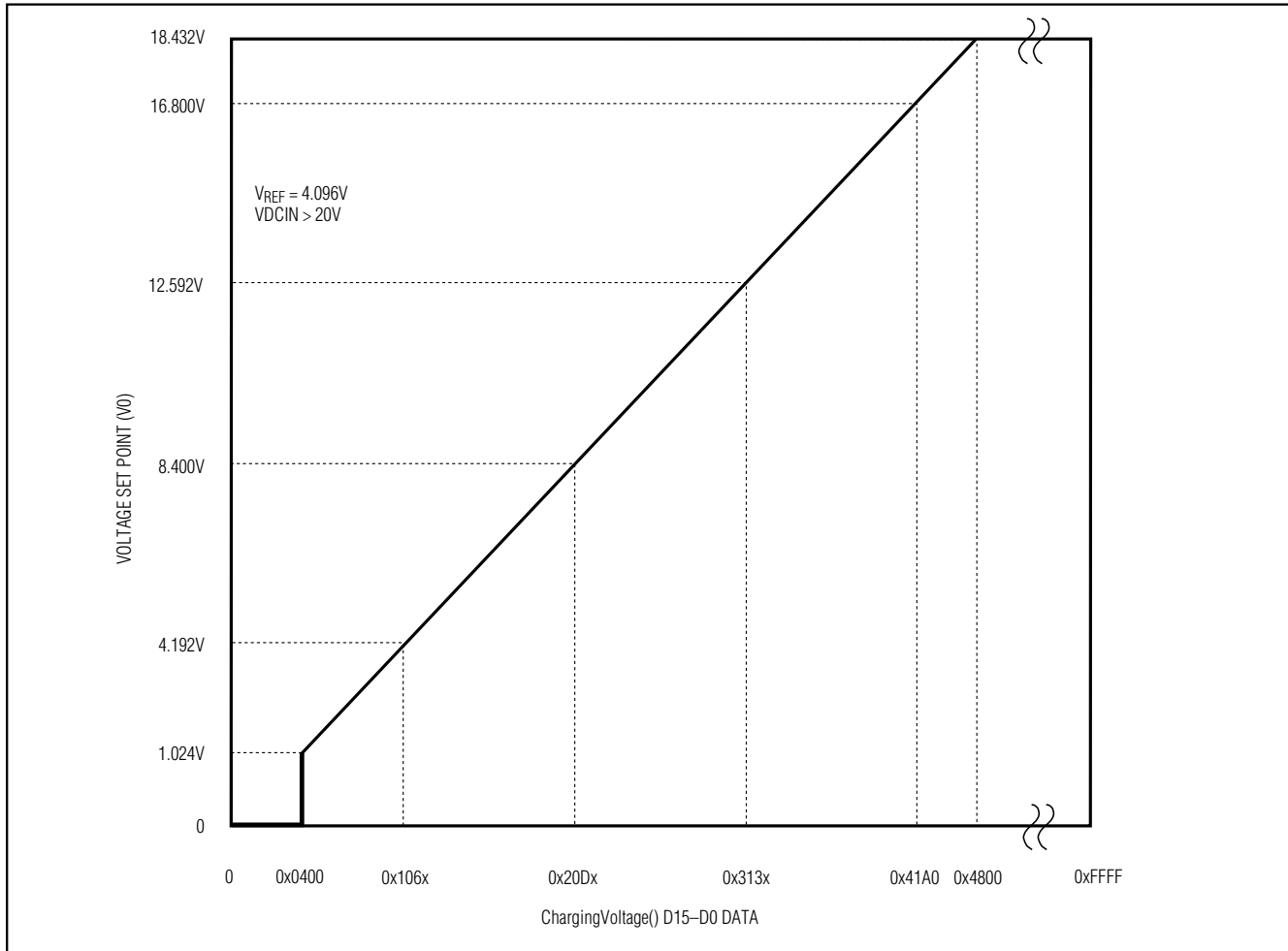

Figure 7. ChargingVoltage() Code to Voltage Mapping

### Charger Timeout

The MAX1645 includes a timer that terminates charge if the charger has not received a ChargingVoltage() or ChargingCurrent() command in 175sec. During charging, the timer is reset each time a ChargingVoltage() or ChargingCurrent() command is received; this ensures that the charging cycle is not terminated.

If timeout occurs, charging will terminate and both ChargingVoltage() and ChargingCurrent() commands are required to restart charging. A power-on reset will also restart charging at 128mA.

### DC-to-DC Converter

The MAX1645 employs a buck regulator with a bootstrapped NMOS high-side switch and a low-side NMOS synchronous rectifier.

### DC-DC Controller

The control scheme is a constant off-time, variable frequency, cycle-by-cycle current mode. The off-time is constant for a given BATT voltage; it varies with  $V_{BATT}$  to keep the ripple current constant. During low-dropout operation, a maximum on-time of 10ms allows the controller to achieve >99% duty cycle with continuous conduction. Figure 8 shows the controller functional diagram.

### MOSFET Drivers

The low-side driver output DLO swings from 0V to DLOV. DLOV is usually connected through a filter to LDO. The high-side driver output DHI is bootstrapped off LX and swings from  $V_{LX}$  to  $V_{BST}$ . When the low-side



# Advanced Chemistry-Independent, Level 2 Battery Charger with Input Current Limiting

**MAX1645**

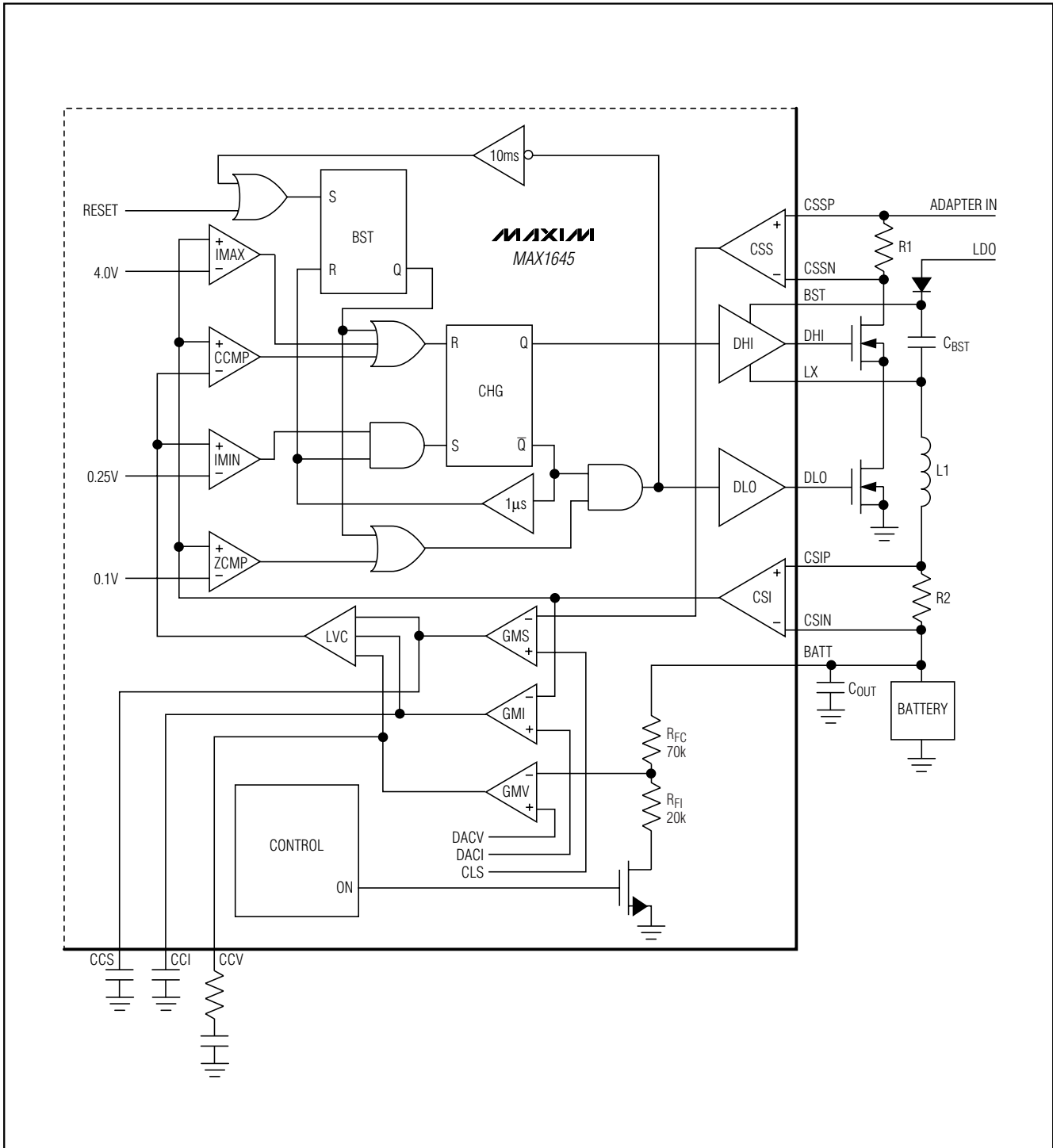

Figure 8. DC-to-DC Converter Functional Diagram

# Advanced Chemistry-Independent, Level 2 Battery Charger with Input Current Limiting

driver turns on, BST rises to one diode voltage below DLOV.

Filter DLOV with an RC circuit whose cutoff frequency is about 50kHz. The configuration in Figure 1 introduces a cutoff frequency of around 48kHz.

$$f = 1 / 2\pi RC = 1 / (2 \cdot \pi \cdot 33\Omega \cdot 0.1\mu\text{F}) = 48\text{kHz}$$

## Thermistor Comparators

Four thermistor comparators evaluate the voltage at the THM input to determine the battery temperature. This input is meant to be used with the internal thermistor connected to ground inside the battery pack. Connect the output of the battery thermistor to THM. Connect a resistor from THM to V<sub>DD</sub>. The resistor-divider sets the voltage at THM. When the charger is not powered up, the battery temperature can still be determined if V<sub>DD</sub> is powered from an external voltage source.

## Thermistor Bits

Figure 9 shows the expected electrical behavior of a 103ETB-type thermistor (nominally 10k $\Omega$  at +25°C  $\pm$ 5% or better) to be used with the MAX1645:

- THERMISTOR\_OR bit is set when the thermistor value is >100k $\Omega$ . This indicates that the thermistor is open or a battery is not present. The charger is set to POR, and the BATTERY\_PRESENT bit is cleared.
- THERMISTOR\_COLD bit is set when the thermistor value is >30k $\Omega$ . The thermistor indicates a cold battery. This bit does not affect the charge.
- THERMISTOR\_HOT bit is set when the thermistor value is <3k $\Omega$ . This is a latched bit and is cleared by

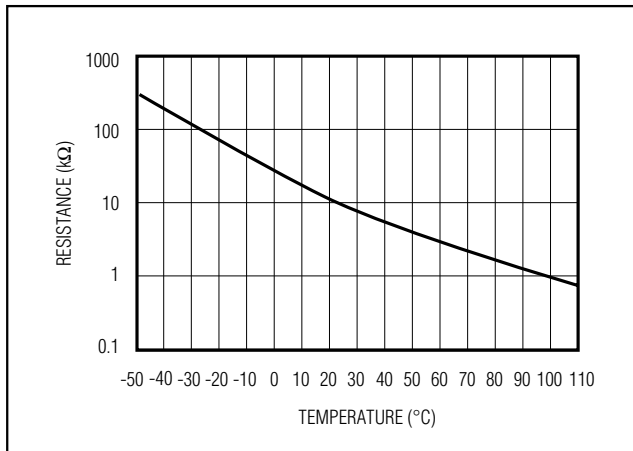

Figure 9. Typical Thermistor Characteristics

removing the battery or sending a POR with the ChargerMode() command. The charger is stopped unless the HOT\_STOP bit is cleared in the ChargerMode() command.

- THERMISTOR\_UR bit is set when the thermistor value is <500 $\Omega$  (i.e., THM is grounded).

Multiple bits may be set depending on the value of the thermistor (e.g., a thermistor that is 450 $\Omega$  will cause both the THERMISTOR\_HOT and the THERMISTOR\_UR bits to be set). The thermistor may be replaced by fixed-value resistors in battery packs that do not require the thermistor as a secondary fail-safe indicator. In this case, it is the responsibility of the battery pack to manipulate the resistance to obtain correct charger behavior.

## Load and Source Switch Drivers

The MAX1645 can drive two P-channel MOSFETs to eliminate voltage drops across the Schottky diodes, which are normally used to switch the load current from the battery to the main DC source:

- The source switch P1 is controlled by PDS. This P-channel MOSFET is turned on when CVS rises to 300mV above BATT and turns off when CVS falls to 100mV above BATT. The same signal that controls the PDS also sets the POWER\_FAIL bit in the Charger Status() register. See *Operating Conditions*.
- The load switch P2 is controlled by PDL. This P-channel MOSFET is turned off when the CVS rises to 100mV below BATT and turns on when CVS falls to 300mV below BATT.

## Dropout Operation

The MAX1645 has a 99.99% duty-cycle capability with a 10ms maximum on-time and 1 $\mu$ s off-time. This allows the charger to achieve dropout performance limited only by resistive losses in the DC-DC converter components (P1, R1, N1, R2; see Figure 1). The actual dropout voltage is limited to 300mV between CVS and BATT by the power-fail comparator (see *Operating Conditions*).

# Advanced Chemistry-Independent, Level 2 Battery Charger with Input Current Limiting

MAX1645

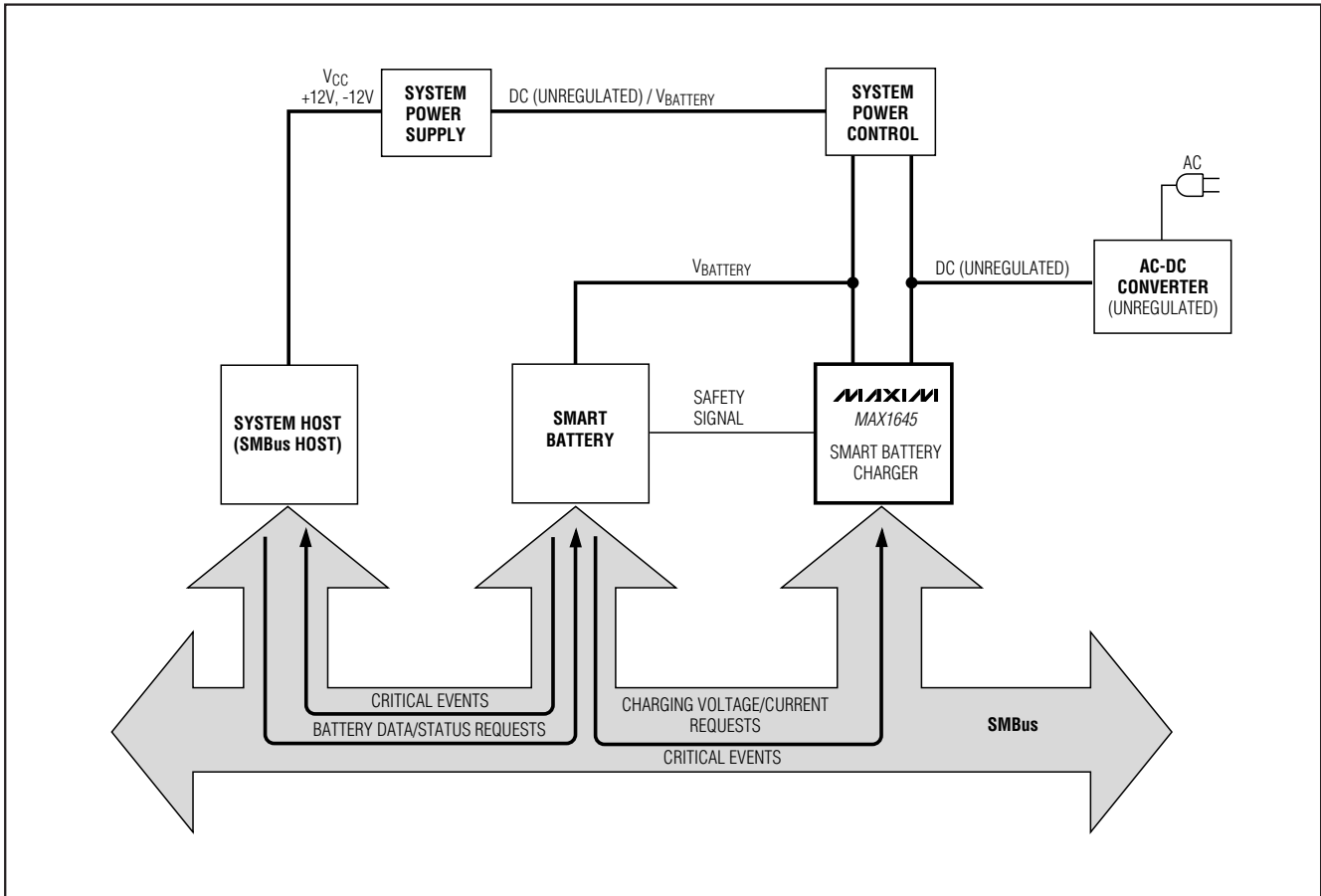

Figure 10. Typical Single Smart Battery System

## Applications Information

### Smart Battery Charging System/Background Information

A smart battery charging system, at a minimum, consists of a smart battery and smart battery charger compatible with the Smart Battery System Specifications using the SMBus.

A system may use one or more smart batteries. Figure 10 shows a single-battery system. This configuration is typically found in notebook computers, video cameras, cellular phones, or other portable electronic equipment.

Another configuration uses two or more smart batteries (Figure 11). The smart battery selector is used either to connect batteries to the smart battery charger or the system, or to disconnect them, as appropriate. For each battery, three connections must be made: power (the battery's positive and negative terminals), the

SMBus (clock and data), and the safety signal (resistance, typically temperature dependent). Additionally, the system host must be able to query any battery so it can display the state of all batteries present in the system.

Figure 11 shows a two-battery system where battery 2 is being charged while battery 1 is powering the system. This configuration may be used to "condition" battery 1, allowing it to be fully discharged prior to recharge.

### Smart Battery Charger Types

Two types of smart battery chargers are defined: Level 2 and Level 3. All smart battery chargers communicate with the smart battery using the SMBus; the two types differ in their SMBus communication mode and whether they modify the charging algorithm of the smart battery (Table 7). Level 3 smart battery chargers are supersets of Level 2 chargers and, as such, support all Level 2 charger commands.

# Advanced Chemistry-Independent, Level 2 Battery Charger with Input Current Limiting

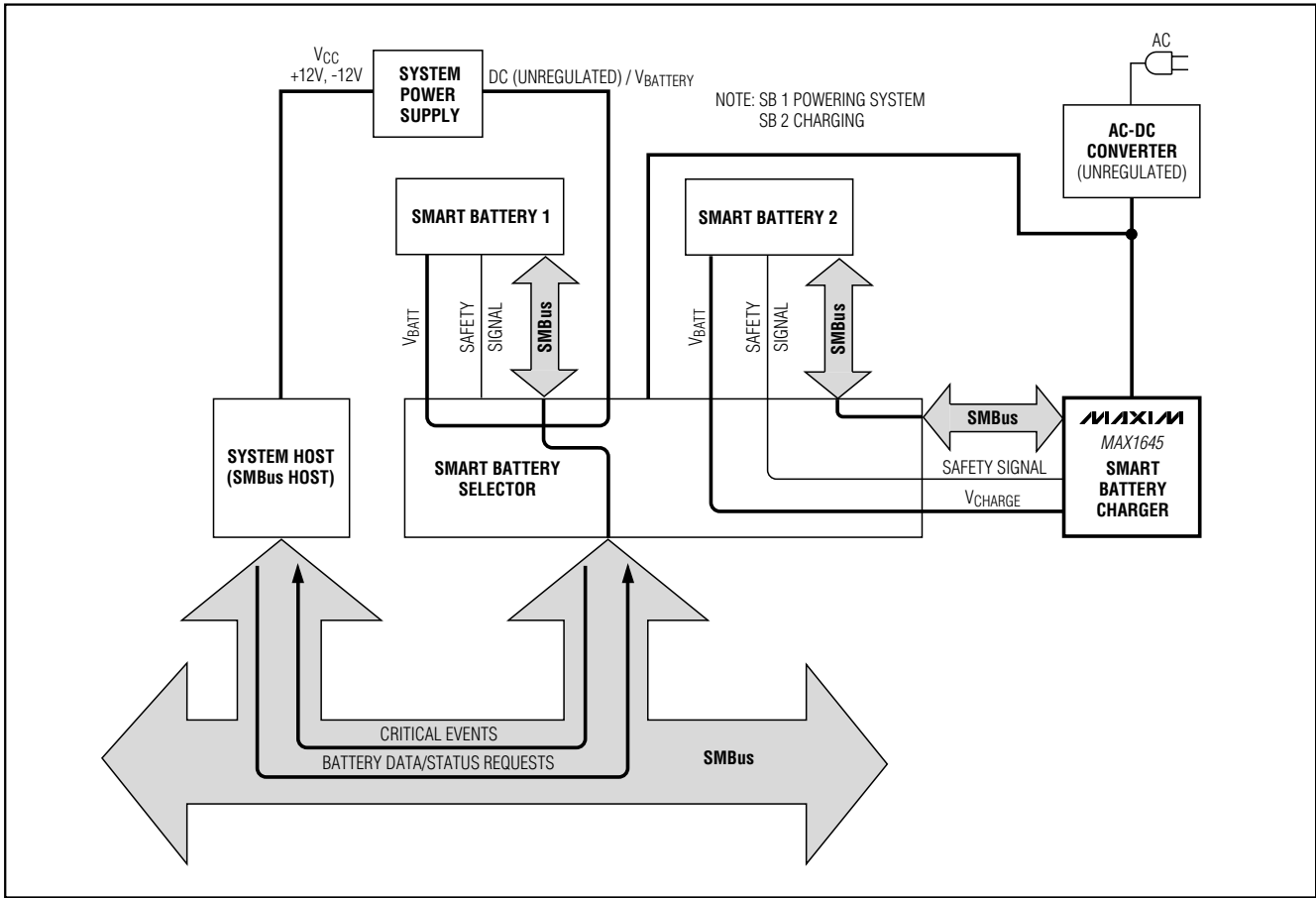

Figure 11. Typical System Using Multiple Smart Batteries

**Table 7. Smart Battery Charger Type by SMBus Mode and Charge Algorithm Source**

SMBus MODE	CHARGE ALGORITHM SOURCE	
	BATTERY	MODIFIED FROM BATTERY
Slave only	Level 2	Level 3
Slave/Master	Level 3	Level 3

**Note:** Level 1 smart battery chargers were defined in the version 0.95a specification. While they can correctly interpret smart battery end-of-charge messages, minimizing over-charge, they do not provide truly chemistry-independent charging. They are no longer defined by the Smart Battery Charger Specification and are explicitly not compliant with this and subsequent Smart Battery Charger Specifications.

## Level 2 Smart Battery Charger

The Level 2 or smart battery-controlled smart battery charger interprets the smart battery’s critical warning messages and operates as an SMBus slave device to respond to the smart battery’s ChargingVoltage() and ChargingCurrent() messages. The charger is obliged to adjust its output characteristics in direct response to the ChargingVoltage() and ChargingCurrent() messages it receives from the battery. In Level 2 charging, the smart battery is completely responsible for initiating the communication and providing the charging algorithm to the charger.

The smart battery is in the best position to tell the smart battery charger how it needs to be charged. The charging algorithm in the battery may request a static charge condition or may choose to periodically adjust the smart battery charger’s output to meet its present needs. A Level 2 smart battery charger is truly chem-

# Advanced Chemistry-Independent, Level 2 Battery Charger with Input Current Limiting

istry independent and, since it is defined as an SMBus slave device only, the smart battery charger is relatively inexpensive and easy to implement.

## Selecting External Components

Table 9 lists the recommended components and refers to the circuit of Figure 1; Table 8 lists the suppliers' contacts. The following sections describe how to select these components.

## MOSFETs and Schottky Diodes

Schottky diode D1 provides power to the load when the AC adapter is inserted. Choose a 3A Schottky diode 3A or higher. This diode may not be necessary if P1 is used. The P-channel MOSFET P1 turns on when  $V_{CVS} > V_{BATT}$ . This eliminates the voltage drop and power consumption of the Schottky diode. To minimize power loss, select a MOSFET with an  $R_{DS(ON)}$  of 50m $\Omega$  or less. This MOSFET must be able to deliver the maximum current as set by R1. D1 and P1 provide protection from reversed voltage at the adapter input.

The N-channel MOSFETs N1 and N2 are the switching devices for the buck controller. High-side switch N1 should have a current rating of at least 6A and have an  $R_{DS(ON)}$  of 50m $\Omega$  or less. The driver for N1 is powered by BST; its current should be less than 10mA. Select a MOSFET with a low total gate charge and determine the required drive current by  $I_{GATE} = Q_{GATE} \cdot f$  (where f is the DC-DC converter maximum switching frequency of 400kHz).

**Table 8. Components Suppliers**

COMPONENT	MANUFACTURER	PART
Inductor	Sumida	CDRH127 series
	Coilcraft	D03316P series
	Coiltronics	UP2 series
MOSFET	Internal Rectifier	IRF7309
	Fairchild	FDS series
	Vishay-Siliconix	Si4435/6
Sense Resistor	Dale	WSL series
	IRC	LR2010-01 series
Capacitor	AVX	TPS series, TAJ series
	Sprague	595D series
Diode	Motorola	1N5817–1N5822
	Nihon	NSQ03A04
	Central Semiconductor	CMSH series

The low-side switch N2 should also have a current rating of at least 3A, have an  $R_{DS(ON)}$  of 100m $\Omega$  or less, and a total gate charge less than 10nC. N2 is used to provide the starting charge to the BST capacitor C14. During normal operation, the current is carried by Schottky diode D2. Choose a 3A or higher Schottky diode.

D3 is a signal-level diode, such as the 1N4148. This diode provides the supply current to the high-side MOSFET driver.

The P-channel MOSFET P2 delivers the current to the load when the AC adapter is removed. Select a MOSFET with an  $R_{DS(ON)}$  of 50m $\Omega$  or less to minimize power loss and voltage drop.

## Inductor Selection

Inductor L1 provides power to the battery while it is being charged. It must have a saturation current of at least 3A plus 1/2 of the current ripple ( $\Delta I_L$ ).

$$I_{SAT} = 3A + 1/2 \Delta I_L$$

The controller determines the constant off-time period, which is dependent on BATT voltage. This makes the ripple current independent of input and battery voltage and should be kept to less than 1A. Calculate the  $\Delta I_L$  with the following equation:

$$\Delta I_L = 16V\mu s / L$$

Higher inductor values decrease the ripple current. Smaller inductor values require higher saturation current capabilities and degrade efficiency. Typically, a 22 $\mu$ H inductor is ideal for all operating conditions.

## Other Components

CCV, CCI, and CCS are the compensation points for the three regulation loops. Bypass CCV with a 10k $\Omega$  resistor in series with a 0.01 $\mu$ F capacitor to GND. Bypass CCI and CCS with 0.01 $\mu$ F capacitors to GND. R7 and R13 serve as protection resistors to THM and CVS, respectively. To achieve acceptable accuracy, R6 should be 10k $\Omega$  and 1% to match the internal battery thermistor.

## Current-Sense Input Filtering

In normal circuit operation with typical components, the current-sense signals can have high-frequency transients that exceed 0.5V due to large current changes and parasitic component inductance. To achieve proper battery and input current compliance, the current-sense input signals should be filtered to remove large common-mode transients. The input current limit sensing circuitry is the most sensitive case due to large current steps in the input filter capacitors (C1 and C2) in

# Advanced Chemistry-Independent, Level 2 Battery Charger with Input Current Limiting

Table 9. Component Selection

DESIGNATION	DESCRIPTION
C1, C2 Input Capacitors	22 $\mu$ F, 35V low-ESR tantalum capacitors AVX TPSE226M035R0300
C3, C4 Output Capacitors	22 $\mu$ F, 25V low-ESR tantalum capacitors AVX TPSD226M025R0200
C5, C19, C20	1 $\mu$ F, >30V ceramic capacitors
C6, C7, C12	1 $\mu$ F ceramic capacitors
C8, C14, C16	0.1 $\mu$ F ceramic capacitors
C9, C10, C11 Compensation Capacitors	0.01 $\mu$ F ceramic capacitors
C13	1500pF ceramic capacitor
C18, C24	0.1 $\mu$ F, >20V ceramic capacitors
C23	0.1 $\mu$ F, >30V ceramic capacitor
D1, D2	40V, 2A schottky diodes Central Semiconductor CMSH2-40
D3, D4	Small-signal diodes Central Semiconductor CMPSH-3
L1	22 $\mu$ H, 3.6A buck inductor Sumida CDRH127-220
N1 High-Side MOSFET	30V, 11.5A, high-side N-channel MOSFET (SO-8) Fairchild FDS6680
N2 Low-Side MOSFET	30V, 8.4A, low-side N-channel MOSFET Fairchild FDS6612A or 30V, signal level N-channel MOSFET 2N7002
P1, P2	30V, 11A P-Channel MOSFET load and source switches Fairchild FDS6675
R1	40m $\Omega$ $\pm$ 1%, 0.5W battery current-sense resistor Dale WSL-2010/40m $\Omega$ /1%
R2	50m $\Omega$ $\pm$ 1%, 0.5W source current-sense resistor Dale WSL-2010/50m $\Omega$ /1%
R3, R4	R3 + R4 >100k $\Omega$ input current-limit setting resistors
R5, R7, R8, R9, R10	10k $\Omega$ $\pm$ 5% resistors
R6	10k $\Omega$ $\pm$ 1% temperature sensor network resistor
R11, R16	1 $\Omega$ $\pm$ 5% resistors
R12	33 $\Omega$ $\pm$ 5% resistor
R13	1k $\Omega$ $\pm$ 5% resistor
R14, R15	4.7 $\Omega$ $\pm$ 5% resistors

# Advanced Chemistry-Independent, Level 2 Battery Charger with Input Current Limiting

Figure 1. Use 1 $\mu$ F ceramic capacitors from CSSP and CSSN to GND. Smaller 0.1 $\mu$ F ceramic capacitors can be used on the CSIP and CSIN inputs to GND since the current into the battery is continuous. Place these capacitors next to the single-point ground directly under the MAX1645.

## Layout and Bypassing

Bypass DCIN with a 1 $\mu$ F to GND (Figure 1). D4 protects the device when the DC power source input is reversed. A signal diode for D4 is adequate as DCIN only powers the LDO and the internal reference. Bypass LDO, BST, DLOV, and other pins as shown in Figure 1.

Good PC board layout is required to achieve specified noise, efficiency, and stable performance. The PC board layout artist must be given explicit instructions, preferably a pencil sketch showing the placement of power-switching components and high-current routing. Refer to the PC board layout in the MAX1645 evaluation kit manual for examples. A ground plane is essential for optimum performance. In most applications, the circuit will be located on a multilayer board, and full use of the four or more copper layers is recommended. Use the top layer for high-current connections, the bottom layer for quiet connections (REF, CCV, CCI, CCS, DAC, DCIN, V<sub>DD</sub>, and GND), and the inner layers for an uninterrupted ground plane.

Use the following step-by-step guide:

- 1) Place the high-power connections first, with their grounds adjacent:
  - Minimize current-sense resistor trace lengths and ensure accurate current sensing with Kelvin connections.
  - Minimize ground trace lengths in the high-current paths.
  - Minimize other trace lengths in the high-current paths:
    - Use > 5mm-wide traces
    - Connect C1 and C2 to high-side MOSFET (10mm max length)
    - Connect rectifier diode cathode to low-side MOSFET (5mm max length)
    - LX node (MOSFETs, rectifier cathode, inductor: 15mm max length). Ideally, surface-mount power components are flush against one another with their ground terminals almost touching. These high-current grounds are then connected to each other with a wide, filled zone of top-layer copper so they do not go through vias.

The resulting top-layer subground plane is connected to the normal inner-layer ground plane at the output ground terminals, which ensures that the IC's analog ground is sensing at the supply's output terminals without interference from IR drops and ground noise. Other high-current paths should also be minimized, but focusing primarily on short ground and current-sense connections eliminates about 90% of all PC board layout problems.

- 2) Place the IC and signal components. Keep the main switching nodes (LX nodes) away from sensitive analog components (current-sense traces and REF capacitor). **Important:** The IC must be no further than 10mm from the current-sense resistors.

Keep the gate drive traces (DHI, DLO, and BST) shorter than 20mm and route them away from the current-sense lines and REF. Place ceramic bypass capacitors close to the IC. The bulk capacitors can be placed further away. Place the current-sense input filter capacitors under the part, connected directly to the GND pin.

- 3) Use a single-point star ground placed directly below the part. Connect the input ground trace, power ground (subground plane), and normal ground to this node.

## Chip Information

TRANSISTOR COUNT: 6996

# Advanced Chemistry-Independent, Level 2 Battery Charger with Input Current Limiting

## Typical Operating Circuit

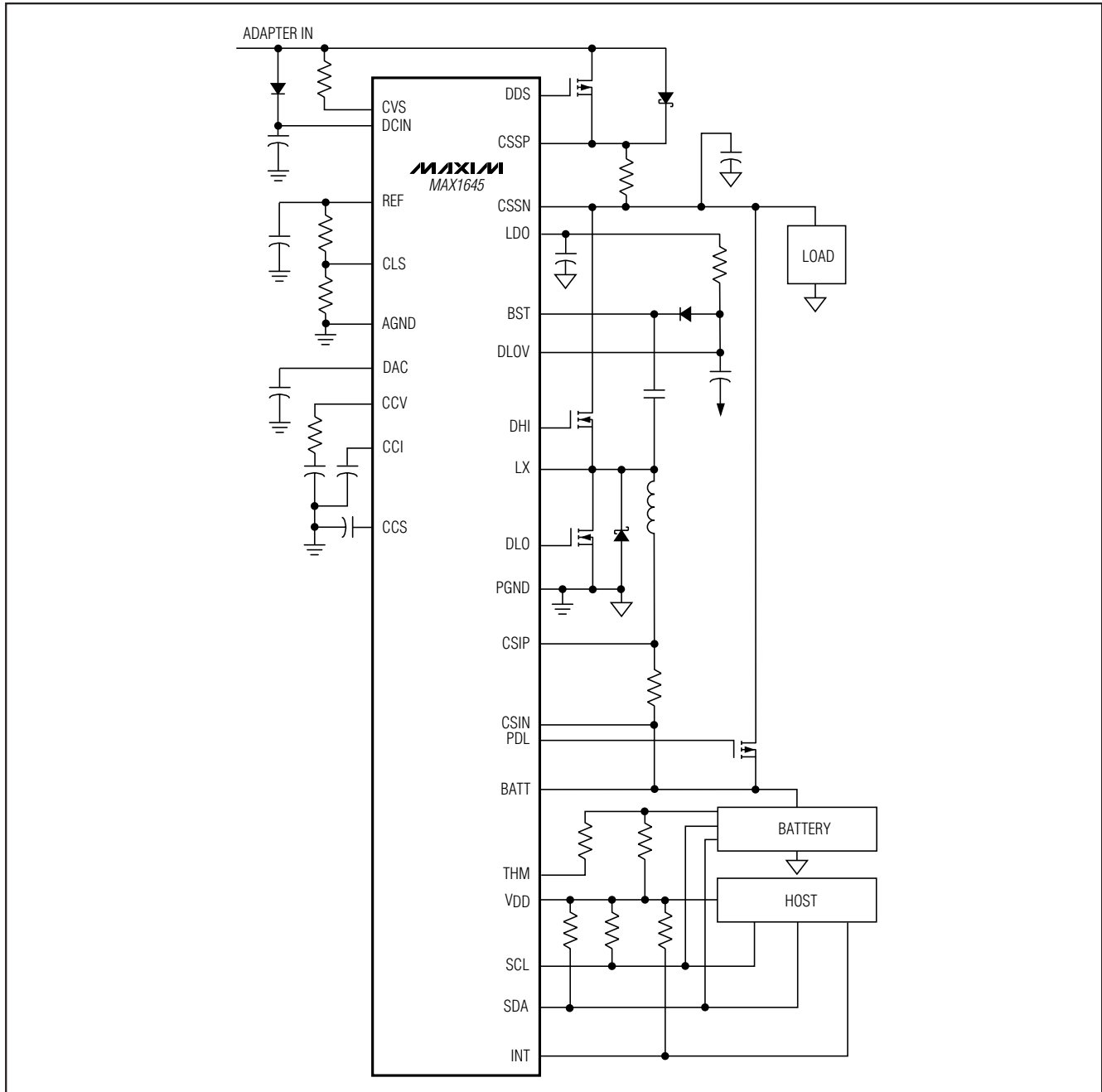

Maxim cannot assume responsibility for use of any circuitry other than circuitry entirely embodied in a Maxim product. No circuit patent licenses are implied. Maxim reserves the right to change the circuitry and specifications without notice at any time.

32 **Maxim Integrated Products, 120 San Gabriel Drive, Sunnyvale, CA 94086 408-737-7600**