

**RADIATION HARDENED  
 POWER MOSFET  
 THRU-HOLE (T0-254AA)**

**IRHM7054  
 JANSR2N7394  
 60V, N-CHANNEL**

**REF: MIL-PRF-19500/663  
 RAD Hard™ HEXFET® TECHNOLOGY**

**Product Summary**

Part Number	Radiation Level	RDS(on)	ID	QPL Part Number
IRHM7054	100K Rads (Si)	0.027Ω	35*A	JANSR2N7394
IRHM3054	300K Rads (Si)	0.027Ω	35*A	JANSF2N7394
IRHM4054	600K Rads (Si)	0.027Ω	35*A	JANSG2N7394
IRHM8054	1000K Rads (Si)	0.027Ω	35*A	JANSH2N7394



International Rectifier's RADHard HEXFET® technology provides high performance power MOSFETs for space applications. This technology has over a decade of proven performance and reliability in satellite applications. These devices have been characterized for both Total Dose and Single Event Effects (SEE). The combination of low Rds(on) and low gate charge reduces the power losses in switching applications such as DC to DC converters and motor control. These devices retain all of the well established advantages of MOSFETs such as voltage control, fast switching, ease of paralleling and temperature stability of electrical parameters.

**Features:**

- Single Event Effect (SEE) Hardened
- Low RDS(on)
- Low Total Gate Charge
- Proton Tolerant
- Simple Drive Requirements
- Ease of Paralleling
- Hermetically Sealed
- Ceramic Package
- Light Weight

**Absolute Maximum Ratings**

**Pre-Irradiation**

	Parameter		Units
ID @ VGS = 12V, TC = 25°C	Continuous Drain Current	35*	A
ID @ VGS = 12V, TC = 100°C	Continuous Drain Current	30	
IDM	Pulsed Drain Current ①	200	
PD @ TC = 25°C	Max. Power Dissipation	150	W
	Linear Derating Factor	1.2	W/°C
VGS	Gate-to-Source Voltage	±20	V
EAS	Single Pulse Avalanche Energy ②	500	mJ
IAR	Avalanche Current ①	35	A
EAR	Repetitive Avalanche Energy ①	15	mJ
dv/dt	Peak Diode Recovery dv/dt ③	3.5	V/ns
TJ	Operating Junction	-55 to 150	°C
TSTG	Storage Temperature Range		
	Lead Temperature	300 ( 0.063 in.(1.6mm) from case for 10s)	
	Weight	9.3 (Typical )	g

For footnotes refer to the last page

\*Current is limited by pin diameter

Electrical Characteristics @ T<sub>j</sub> = 25°C (Unless Otherwise Specified)

	Parameter	Min	Typ	Max	Units	Test Conditions
BV <sub>DSS</sub>	Drain-to-Source Breakdown Voltage	60	—	—	V	V <sub>GS</sub> = 0V, I <sub>D</sub> = 1.0mA
ΔBV <sub>DSS</sub> /ΔT <sub>J</sub>	Temperature Coefficient of Breakdown Voltage	—	0.053	—	V/°C	Reference to 25°C, I <sub>D</sub> = 1.0mA
R <sub>DSS(on)</sub>	Static Drain-to-Source On-State Resistance	—	—	0.027	Ω	V <sub>GS</sub> = 12V, I <sub>D</sub> = 30A <sup>④</sup>
		—	—	0.030		
V <sub>GS(th)</sub>	Gate Threshold Voltage	2.0	—	4.0	V	V <sub>DS</sub> = V <sub>GS</sub> , I <sub>D</sub> = 1.0mA
g <sub>fs</sub>	Forward Transconductance	12	—	—	S (Ω)	V <sub>DS</sub> > 15V, I <sub>DS</sub> = 30A <sup>④</sup>
I <sub>DSS</sub>	Zero Gate Voltage Drain Current	—	—	25	μA	V <sub>DS</sub> = 48V, V <sub>GS</sub> = 0V
		—	—	250		
I <sub>GSS</sub>	Gate-to-Source Leakage Forward	—	—	100	nA	V <sub>GS</sub> = 20V
I <sub>GSS</sub>	Gate-to-Source Leakage Reverse	—	—	-100	nA	V <sub>GS</sub> = -20V
Q <sub>g</sub>	Total Gate Charge	—	—	200	nC	V <sub>GS</sub> = 12V, I <sub>D</sub> = 35A V <sub>DS</sub> = 30V
Q <sub>gs</sub>	Gate-to-Source Charge	—	—	60		
Q <sub>gd</sub>	Gate-to-Drain ('Miller') Charge	—	—	75		
t <sub>d(on)</sub>	Turn-On Delay Time	—	—	27	ns	V <sub>DD</sub> = 30V, I <sub>D</sub> = 35A V <sub>GS</sub> = 12V, R <sub>G</sub> = 2.35Ω
t <sub>r</sub>	Rise Time	—	—	100		
t <sub>d(off)</sub>	Turn-Off Delay Time	—	—	75		
t <sub>f</sub>	Fall Time	—	—	75		
L <sub>S</sub> + L <sub>D</sub>	Total Inductance	—	6.8	—	nH	Measured from Drain lead (6mm / 0.25in from package) to Source lead (6mm / 0.25in. from Package) with Source wires internally bonded from Source Pin to Drain Pad
C <sub>iss</sub>	Input Capacitance	—	4100	—	pF	V <sub>GS</sub> = 0V, V <sub>DS</sub> = 25V f = 1.0MHz
C <sub>OSS</sub>	Output Capacitance	—	2000	—		
C <sub>rSS</sub>	Reverse Transfer Capacitance	—	560	—		

## Source-Drain Diode Ratings and Characteristics

	Parameter	Min	Typ	Max	Units	Test Conditions
I <sub>S</sub>	Continuous Source Current (Body Diode)	—	—	35*	A	T <sub>j</sub> = 25°C, I <sub>S</sub> = 35A, V <sub>GS</sub> = 0V <sup>④</sup>
I <sub>SM</sub>	Pulse Source Current (Body Diode) ①	—	—	220		
V <sub>SD</sub>	Diode Forward Voltage	—	—	1.4	V	T <sub>j</sub> = 25°C, I <sub>F</sub> = 35A, di/dt ≤ 100A/μs
t <sub>rr</sub>	Reverse Recovery Time	—	—	280	nS	V <sub>DD</sub> ≤ 50V <sup>④</sup>
Q <sub>RR</sub>	Reverse Recovery Charge	—	—	2.2	μC	
t <sub>on</sub>	Forward Turn-On Time	Intrinsic turn-on time is negligible. Turn-on speed is substantially controlled by L <sub>S</sub> + L <sub>D</sub> .				

\* Current is limited by pin diameter

## Thermal Resistance

	Parameter	Min	Typ	Max	Units	Test Conditions
R <sub>thJC</sub>	Junction-to-Case	—	—	0.83	°C/W	Typical socket mount
R <sub>thJA</sub>	Junction-to-Ambient	—	—	48		
R <sub>thCS</sub>	Case-to-Sink	—	0.21	—		

Note: Corresponding Spice and Saber models are available on the G&S Website.

For footnotes refer to the last page

International Rectifier Radiation Hardened MOSFETs are tested to verify their radiation hardness capability. The hardness assurance program at International Rectifier is comprised of two radiation environments. Every manufacturing lot is tested for total ionizing dose (per notes 5 and 6) using the TO-3 package. Both pre- and post-irradiation performance are tested and specified using the same drive circuitry and test conditions in order to provide a direct comparison.

**Table 1. Electrical Characteristics @ Tj = 25°C, Post Total Dose Irradiation ⑤⑥**

Parameter	100K Rads(Si) <sup>1</sup>	300 - 1000K Rads (Si) <sup>2</sup>	Units		Test Conditions		
			Min	Max			
BVDSS	Drain-to-Source Breakdown Voltage	60	—	60	—	V	V <sub>GS</sub> = 0V, I <sub>D</sub> = 1.0mA
V <sub>GS(th)</sub>	Gate Threshold Voltage	2.0	4.0	1.25	4.5		V <sub>GS</sub> = V <sub>DS</sub> , I <sub>D</sub> = 1.0mA
I <sub>GSS</sub>	Gate-to-Source Leakage Forward	—	100	—	100	nA	V <sub>GS</sub> = 20V
I <sub>GSS</sub>	Gate-to-Source Leakage Reverse	—	-100	—	-100		V <sub>GS</sub> = -20 V
I <sub>DSS</sub>	Zero Gate Voltage Drain Current	—	25	—	50	µA	V <sub>DS</sub> =48V, V <sub>GS</sub> =0V
R <sub>DS(on)</sub>	Static Drain-to-Source ④	—	0.027	—	0.04	Ω	V <sub>GS</sub> = 12V, I <sub>D</sub> = 30A
	On-State Resistance (TO-3)						
R <sub>DS(on)</sub>	Static Drain-to-Source ④	—	0.027	—	0.04	Ω	V <sub>GS</sub> = 12V, I <sub>D</sub> = 30A
	On-State Resistance (TO-254AA)						
V <sub>SD</sub>	Diode Forward Voltage ④	—	1.4	—	1.4	V	V <sub>GS</sub> = 0V, I <sub>S</sub> = 35A

1. Part numbers IRHM7054 (JANSR2N7394)

2. Part number IRHM3054, IRHM4054 and IRHM8054 ( JANSF2N7394, JANSG2N7394, JANSH2N7394)

International Rectifier radiation hardened MOSFETs have been characterized in heavy ion environment for Single Event Effects (SEE). Single Event Effects characterization is illustrated in Fig. a and Table 2.

**Table 2. Single Event Effect Safe Operating Area**

Ion	LET MeV/(mg/cm <sup>2</sup> )	Energy (MeV)	Range (µm)	V <sub>DS</sub> (V)				
				@V <sub>GS</sub> =0V	@V <sub>GS</sub> =-5V	@V <sub>GS</sub> =-10V	@V <sub>GS</sub> =-15V	@V <sub>GS</sub> =-20V
I	59.9	345	32.8	60	60	45	40	30
Br	36.8	305	39	40	35	30	25	20

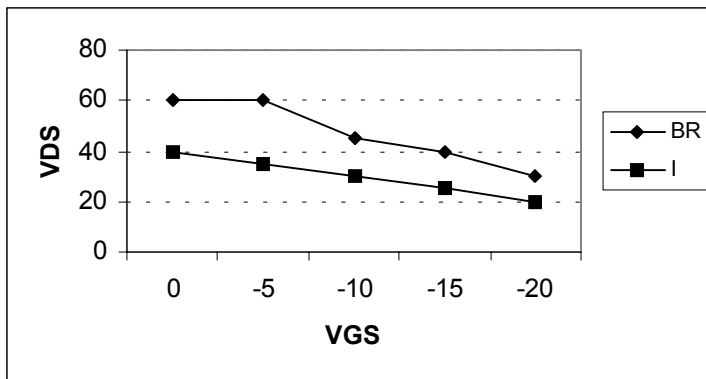

**Fig a. Single Event Effect, Safe Operating Area**

For footnotes refer to the last page

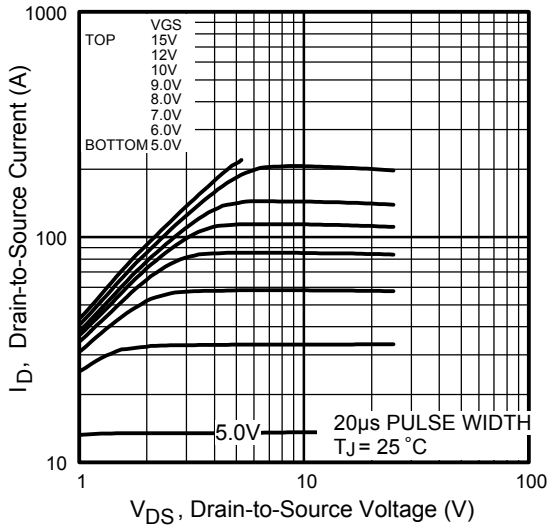

Fig 1. Typical Output Characteristics

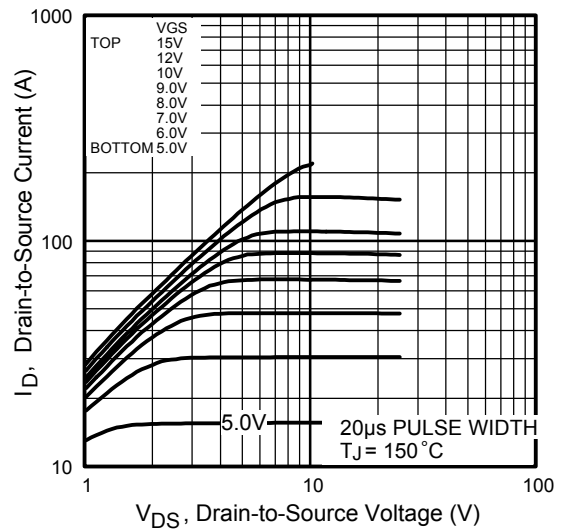

Fig 2. Typical Output Characteristics

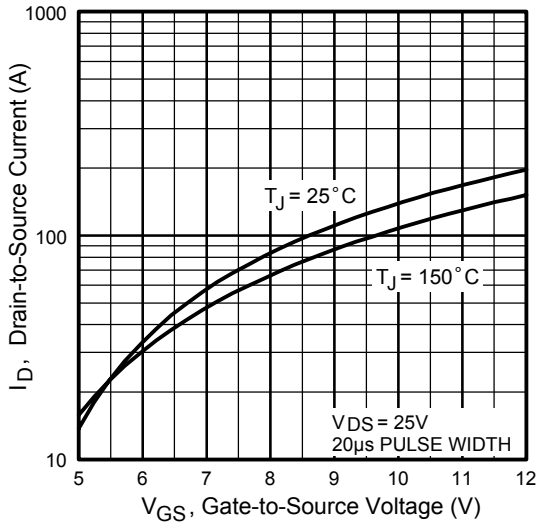

Fig 3. Typical Transfer Characteristics

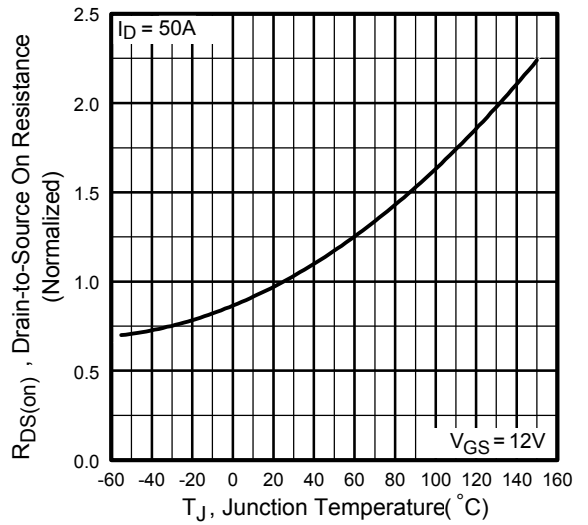
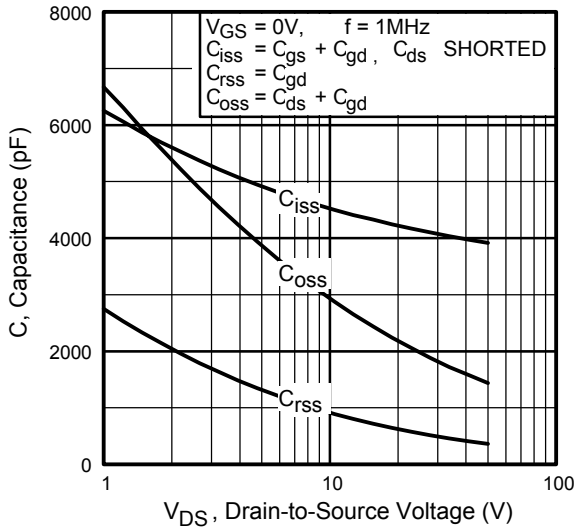
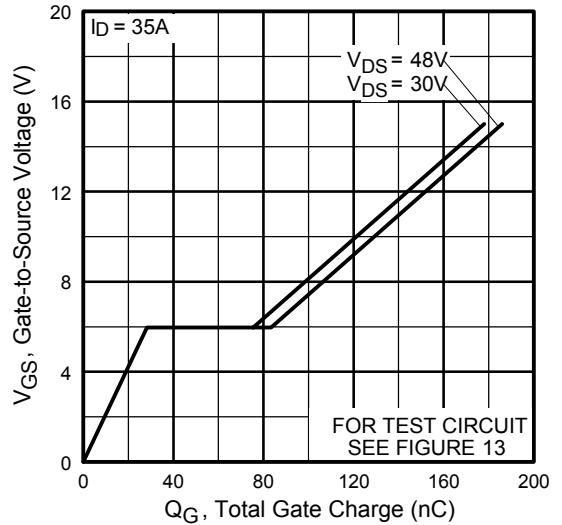

Fig 4. Normalized On-Resistance Vs. Temperature



**Fig 5.** Typical Capacitance Vs. Drain-to-Source Voltage



**Fig 6.** Typical Gate Charge Vs. Gate-to-Source Voltage

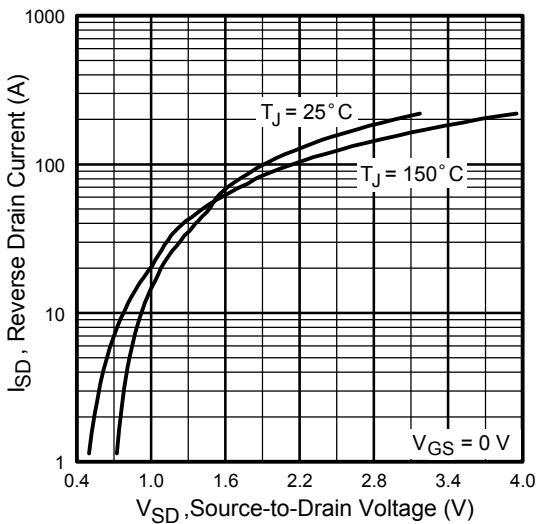

**Fig 7.** Typical Source-Drain Diode Forward Voltage

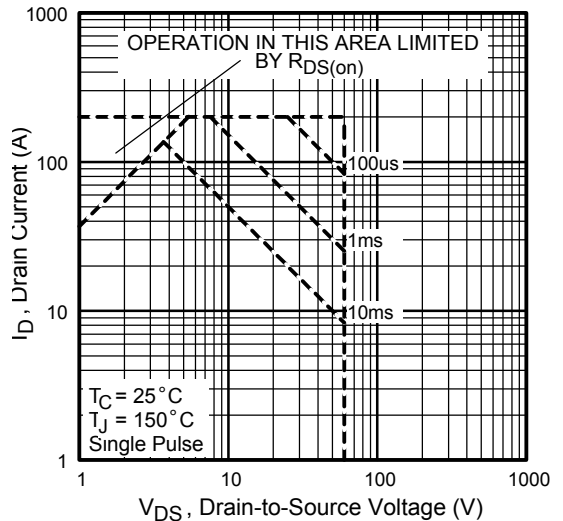

**Fig 8.** Maximum Safe Operating Area

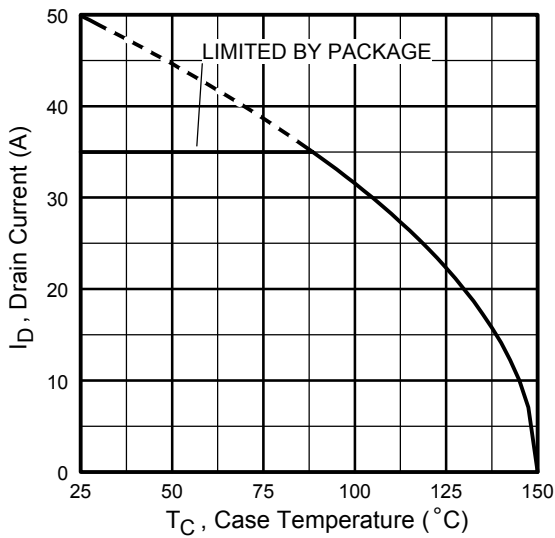

Case Temperature

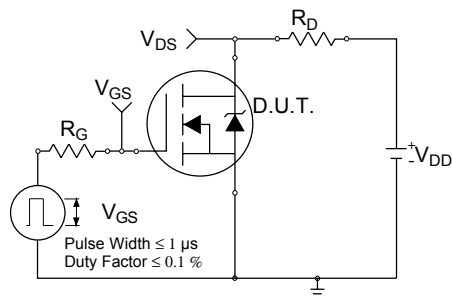

Fig 10a. Switching Time Test Circuit

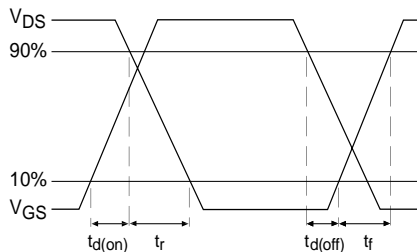

Fig 10b. Switching Time Waveforms

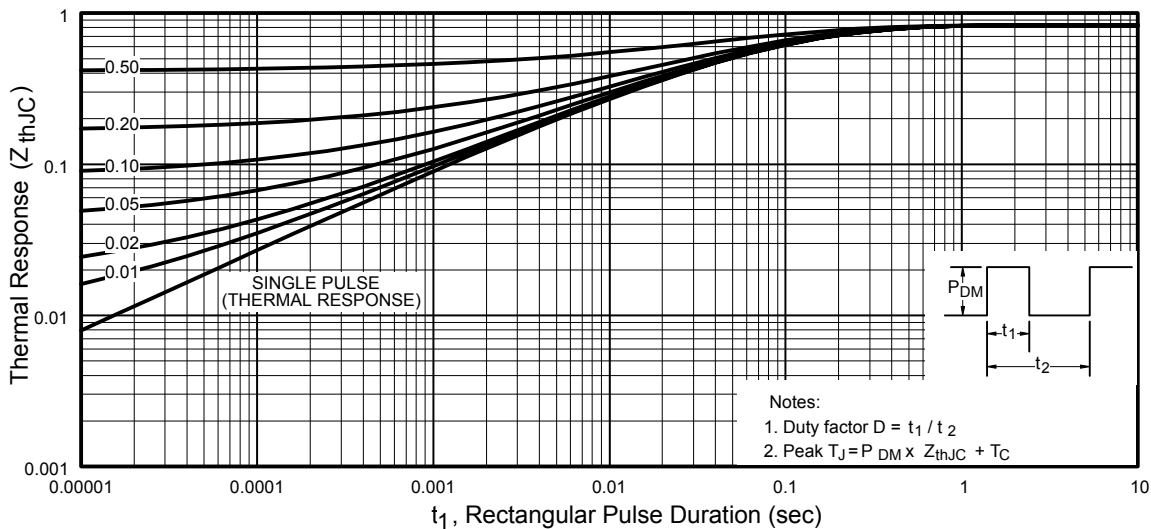

Fig 11. Maximum Effective Transient Thermal Impedance, Junction-to-Case

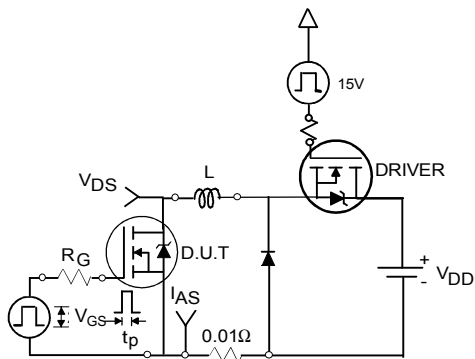

Fig 12a. Unclamped Inductive Test Circuit

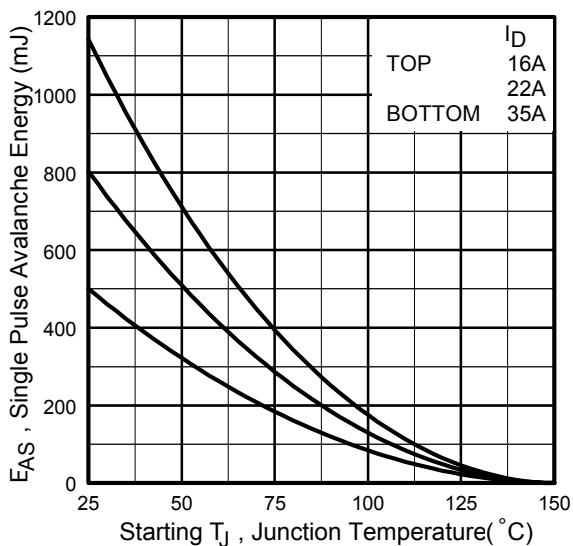

Fig 12c. Maximum Avalanche Energy Vs. Drain Current

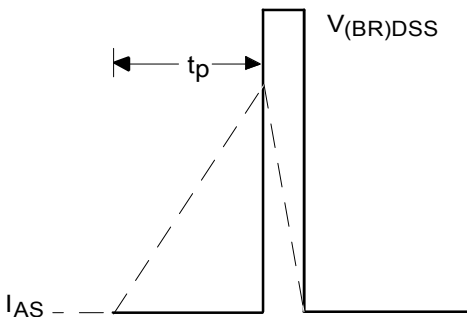

Fig 12b. Unclamped Inductive Waveforms

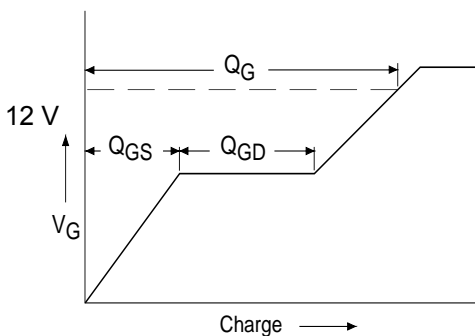

Fig 13a. Basic Gate Charge Waveform

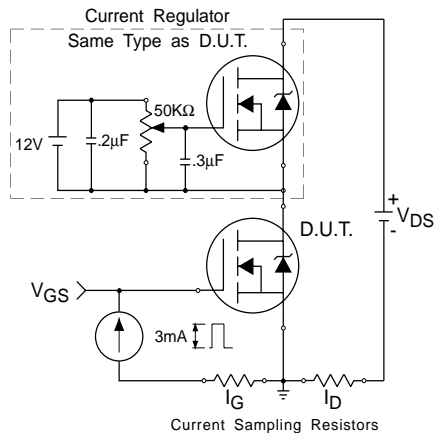
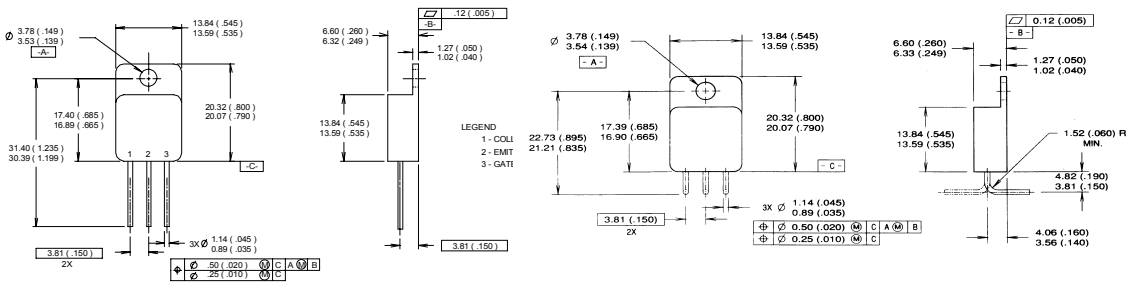

Fig 13b. Gate Charge Test Circuit

Foot Notes:

- ① Repetitive Rating; Pulse width limited by maximum junction temperature.
- ②  $V_{DD} = 25V$ , starting  $T_J = 25^\circ C$ ,  $L=0.82mH$   
Peak  $I_L = 35A$ ,  $V_{GS} = 12V$
- ③  $I_{SD} \leq 35A$ ,  $di/dt \leq 150A/\mu s$ ,  
 $V_{DD} \leq 60V$ ,  $T_J \leq 150^\circ C$
- ④ Pulse width  $\leq 300 \mu s$ ; Duty Cycle  $\leq 2\%$
- ⑤ **Total Dose Irradiation with  $V_{GS}$  Bias.**  
12 volt  $V_{GS}$  applied and  $V_{DS} = 0$  during irradiation per MIL-STD-750, method 1019, condition A.
- ⑥ **Total Dose Irradiation with  $V_{DS}$  Bias.**  
48 volt  $V_{DS}$  applied and  $V_{GS} = 0$  during irradiation per MIL-STD-750, method 1019, condition A.

Case Outline and Dimensions — TO-254AA



NOTES:

- 1. DIMENSIONING & TOLERANCING PER ANSI Y14.5M-1982.
- 2. DIMENSIONS ARE SHOWN IN MILLIMETERS [INCHES].
- 3. LEADFORM IS AVAILABLE IN EITHER ORIENTATION

CAUTION

**BERYLLIA WARNING PER MIL-PRF-19500**

Package containing beryllia shall not be ground, sandblasted, machined, or have other operations performed on them which will produce beryllia or beryllium dust. Furthermore, beryllium oxide packages shall not be placed in acids that will produce fumes containing beryllium.



IR WORLD HEADQUARTERS: 233 Kansas St., El Segundo, California 90245, USA Tel: (310) 252-7105  
TAC Fax: (310) 252-7903

Visit us at [www.irf.com](http://www.irf.com) for sales contact information.  
Data and specifications subject to change without notice. 08/01