

STANDARD RECOVERY DIODES

Hockey Puk Version

Features

- Wide current range
- High voltage ratings up to 2500V
- High surge current capabilities
- Diffused junction
- Hockey Puk version
- Case style DO-200AC (K-PUK)

Typical Applications

- Converters
- Power supplies
- Machine tool controls
- High power drives
- Medium traction applications

3000A

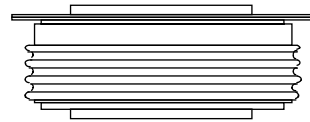

case style DO-200AC (K-PUK)

Major Ratings and Characteristics

Parameters	SD2500C..K	Units	
$I_{F(AV)}$	3000	A	
@ T_{hs}	55	°C	
$I_{F(RMS)}$	5000	A	
@ T_{hs}	25	°C	
I_{FSM}	@ 50Hz	31000	A
	@ 60Hz	32460	A
I^2t	@ 50Hz	4810	KA ² s
	@ 60Hz	4390	KA ² s
V_{RRM} range	1200 to 2500	V	
T_J	- 40 to 180	°C	

SD2500C..K Series

Bulletin I2089 rev. B 04/00

International
IRF Rectifier

ELECTRICAL SPECIFICATIONS

Voltage Ratings

Type number	Voltage Code	V_{RRM} : maximum repetitive peak reverse voltage V	V_{RSM} : maximum non-repetitive peak rev. voltage V	I_{RRM} max. @ $T_J = 180^\circ\text{C}$ mA
SD2500C..K	12	1200	1300	75
	16	1600	1700	
	20	2000	2100	
	25	2500	2600	

Forward Conduction

Parameter	SD2500C..K	Units	Conditions
$I_{F(AV)}$ Max. average forward current @ Heatsink temperature	3000 (1550)	A	180° conduction, half sine wave
	55 (85)	°C	Double side (single side) cooled
$I_{F(RMS)}$ Max. RMS forward current	5000	A	@ 25°C heatsink temperature double side cooled
I_{FSM} Max. peak, one-cycle forward, non-repetitive surge current	31000	A	t = 10ms No voltage reappplied
	32460		t = 8.3ms reappplied
	26050		t = 10ms 100% V_{RRM} reappplied
	27300		t = 8.3ms reappplied
I^2t Maximum I^2t for fusing	4810	KA ² s	t = 10ms No voltage reappplied
	4390		t = 8.3ms reappplied
	3400		t = 10ms 100% V_{RRM} reappplied
	3100		t = 8.3ms reappplied
$I^2\sqrt{t}$ Maximum $I^2\sqrt{t}$ for fusing	48100	KA ² √s	t = 0.1 to 10ms, no voltage reappplied
$V_{F(TO)1}$ Low level value of threshold voltage	0.76	V	(16.7% x π x $I_{F(AV)}$) < I < π x $I_{F(AV)}$, $T_J = T_J$ max.
$V_{F(TO)2}$ High level value of threshold voltage	0.97		(I > π x $I_{F(AV)}$), $T_J = T_J$ max.
r_{f1} Low level value of forward slope resistance	0.16	mΩ	(16.7% x π x $I_{F(AV)}$) < I < π x $I_{F(AV)}$, $T_J = T_J$ max.
r_{f2} High level value of forward slope resistance	0.13		(I > π x $I_{F(AV)}$), $T_J = T_J$ max.
V_{FM} Max. forward voltage drop	1.41	V	$I_{pk} = 4000\text{A}$, $T_J = T_J$ max, $t_p = 10\text{ms}$ sinusoidal wave

Thermal and Mechanical Specifications

Parameter	SD2500C..K	Units	Conditions
T _J Max. junction operating temperature range	-40 to 180	°C	
T _{stg} Max. storage temperature range	-55 to 200		
R _{thJ-hs} Max. thermal resistance, junction to heatsink	0.042 0.020	K/W	DC operation single side cooled DC operation double side cooled
F Mounting force, ± 10%	22250 (2250)	N (Kg)	
wt Approximate weight	425	g	
Case style	DO-200AC(K-PUK)		See Outline Table

ΔR_{thJ-hs} Conduction

(The following table shows the increment of thermal resistance R_{thJ-hs} when devices operate at different conduction angles than DC)

Conduction angle	Sinusoidal conduction		Rectangular conduction		Units	Conditions
	Single Side	Double Side	Single Side	Double Side		
180°	0.002	0.002	0.001	0.001	K/W	T _J = T _J max.
120°	0.002	0.002	0.002	0.002		
90°	0.003	0.003	0.003	0.003		
60°	0.004	0.004	0.004	0.004		
30°	0.007	0.007	0.007	0.007		

Ordering Information Table

Device Code													
<table border="1" style="margin: auto;"> <tr> <td style="padding: 5px;">SD</td> <td style="padding: 5px;">250</td> <td style="padding: 5px;">0</td> <td style="padding: 5px;">C</td> <td style="padding: 5px;">25</td> <td style="padding: 5px;">K</td> </tr> <tr> <td style="text-align: center;">①</td> <td style="text-align: center;">②</td> <td style="text-align: center;">③</td> <td style="text-align: center;">④</td> <td style="text-align: center;">⑤</td> <td style="text-align: center;">⑥</td> </tr> </table>	SD	250	0	C	25	K	①	②	③	④	⑤	⑥	
SD	250	0	C	25	K								
①	②	③	④	⑤	⑥								
<ul style="list-style-type: none"> 1 - Diode 2 - Essential part number 3 - 0 = Standard recovery 4 - C = Ceramic Puk 5 - Voltage code: code x 100 = V_{RRM} (see Voltage Ratings Table) 6 - K = Puk Case DO-200AC (K-PUK) 													

SD2500C..K Series

Bulletin I2089 rev. B 04/00

International
IRF Rectifier

Outline Table

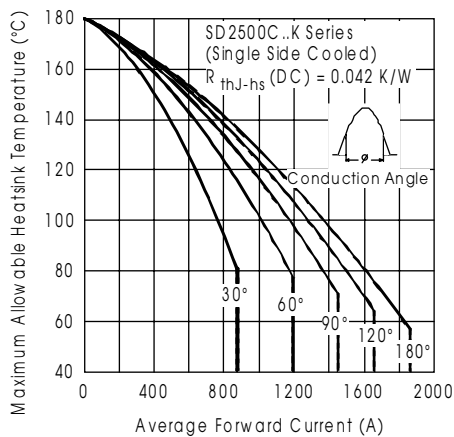
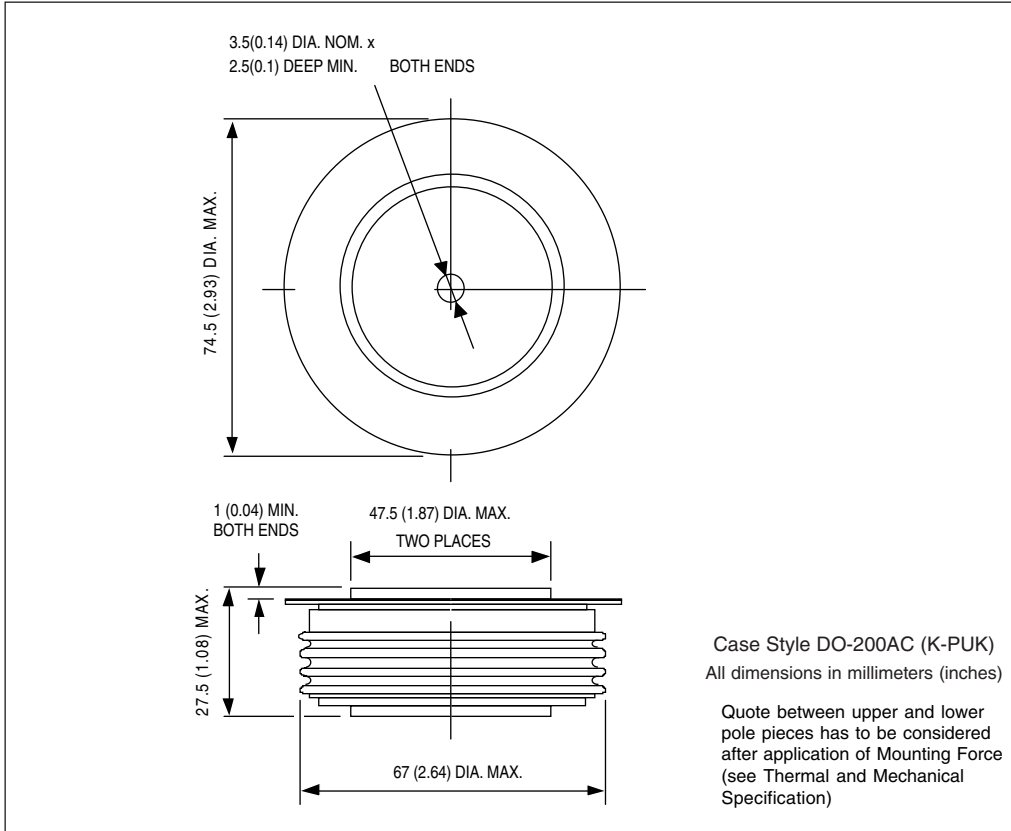

Fig. 1 - Current Ratings Characteristics

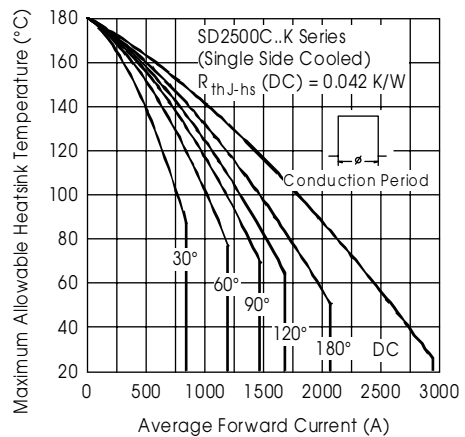

Fig. 2 - Current Ratings Characteristics

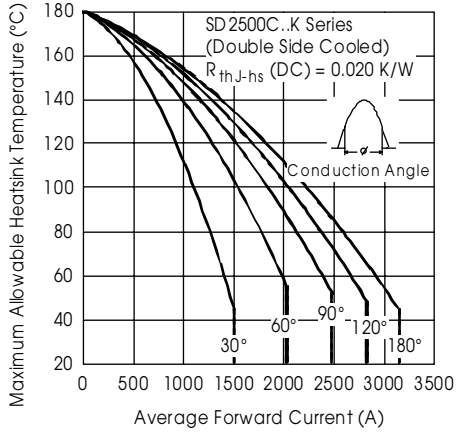

Fig. 3 - Current Ratings Characteristics

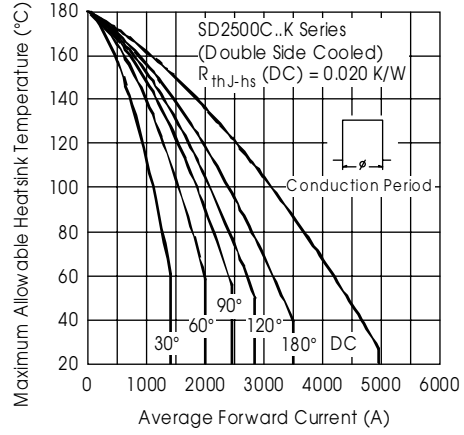

Fig. 4 - Current Ratings Characteristics

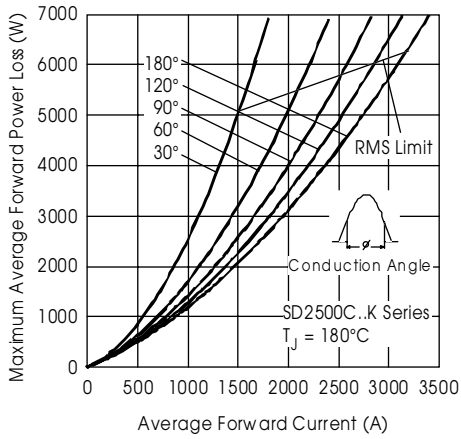

Fig. 5 - Forward Power Loss Characteristics

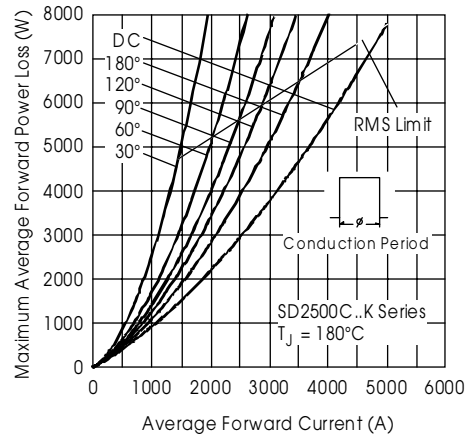

Fig. 6 - Forward Power Loss Characteristics

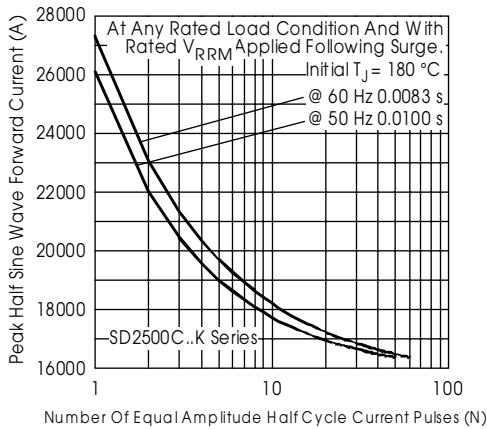

Fig. 7 - Maximum Non-Repetitive Surge Current
Single and Double Side Cooled

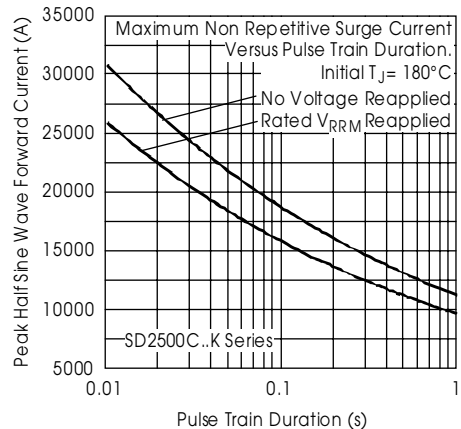

Fig. 8 - Maximum Non-Repetitive Surge Current
Single and Double Side Cooled

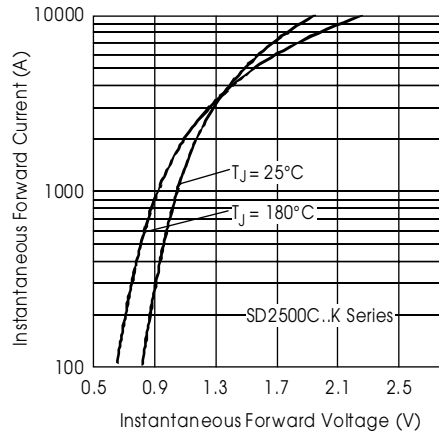

Fig. 9 - Forward Voltage Drop Characteristics

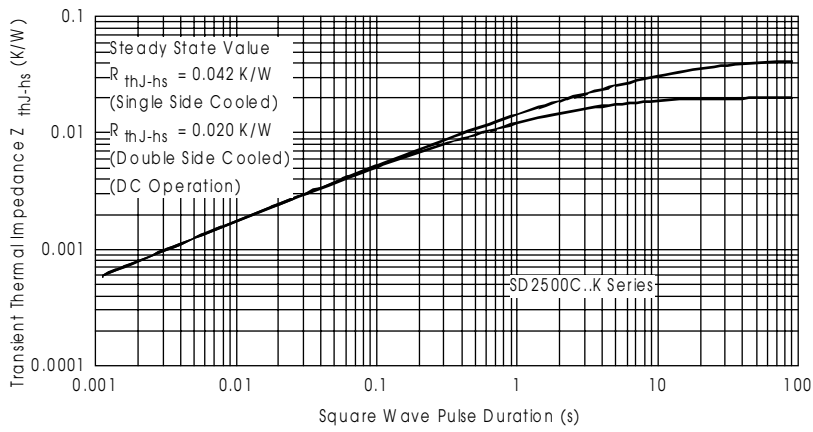

Fig. 10 - Thermal Impedance Z_{thJC} Characteristics