

**24A, 600V, UFS Series N-Channel IGBT with Anti-Parallel Hyperfast Diode**

The HGTG12N60C3D is a MOS gated high voltage switching device combining the best features of MOSFETs and bipolar transistors. The device has the high input impedance of a MOSFET and the low on-state conduction loss of a bipolar transistor. The much lower on-state voltage drop varies only moderately between 25°C and 150°C. The IGBT used is the development type TA49123. The diode used in anti parallel with the IGBT is the development type TA49061.

The IGBT is ideal for many high voltage switching applications operating at moderate frequencies where low conduction losses are essential.

Formerly Developmental Type TA49117.

**Ordering Information**

| PART NUMBER  | PACKAGE | BRAND     |
|--------------|---------|-----------|
| HGTG12N60C3D | TO-247  | G12N60C3D |

NOTE: When ordering, use the entire part number.

**Features**

- 24A, 600V at  $T_C = 25^\circ\text{C}$
- Typical Fall Time . . . . . 210ns at  $T_J = 150^\circ\text{C}$
- Short Circuit Rating
- Low Conduction Loss
- Hyperfast Anti-Parallel Diode

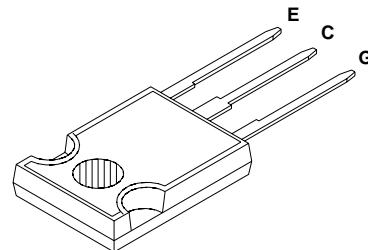
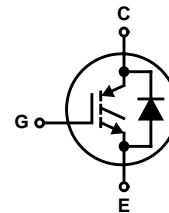
**Packaging**
**JEDEC STYLE TO-247**

**Symbol**

**INTERSIL CORPORATION IGBT PRODUCT IS COVERED BY ONE OR MORE OF THE FOLLOWING U.S. PATENTS**

|           |           |           |           |           |           |           |           |
|-----------|-----------|-----------|-----------|-----------|-----------|-----------|-----------|
| 4,364,073 | 4,417,385 | 4,430,792 | 4,443,931 | 4,466,176 | 4,516,143 | 4,532,534 | 4,587,713 |
| 4,598,461 | 4,605,948 | 4,620,211 | 4,631,564 | 4,639,754 | 4,639,762 | 4,641,162 | 4,644,637 |
| 4,682,195 | 4,684,413 | 4,694,313 | 4,717,679 | 4,743,952 | 4,783,690 | 4,794,432 | 4,801,986 |
| 4,803,533 | 4,809,045 | 4,809,047 | 4,810,665 | 4,823,176 | 4,837,606 | 4,860,080 | 4,883,767 |
| 4,888,627 | 4,890,143 | 4,901,127 | 4,904,609 | 4,933,740 | 4,963,951 | 4,969,027 |           |

# HGTG12N60C3D

## Absolute Maximum Ratings $T_C = 25^\circ\text{C}$ , Unless Otherwise Specified

|  | HGTG12N60C3D   | UNITS       |                     |
|--|----------------|-------------|---------------------|
| Collector to Emitter Voltage . . . . .                                   | $BV_{CES}$     | 600         | V                   |
| Collector Current Continuous   |                |             |                     |
| At $T_C = 25^\circ\text{C}$ . . . . .                                    | $I_{C25}$      | 24          | A                   |
| At $T_C = 110^\circ\text{C}$ . . . . .                                   | $I_{C110}$     | 12          | A                   |
| Average Diode Forward Current at $110^\circ\text{C}$ . . . . .           | $I_{(AVG)}$    | 15          | A                   |
| Collector Current Pulsed (Note 1) . . . . .                              | $I_{CM}$       | 96          | A                   |
| Gate to Emitter Voltage Continuous . . . . .                             | $V_{GES}$      | $\pm 20$    | V                   |
| Gate to Emitter Voltage Pulsed . . . . .                                 | $V_{GEM}$      | $\pm 30$    | V                   |
| Switching Safe Operating Area at $T_J = 150^\circ\text{C}$ . . . . .     | SSOA           | 24A at 600V |                     |
| Power Dissipation Total at $T_C = 25^\circ\text{C}$ . . . . .            | $P_D$          | 104         | W                   |
| Power Dissipation Derating $T_C > 25^\circ\text{C}$ . . . . .            |                | 0.83        | W/ $^\circ\text{C}$ |
| Operating and Storage Junction Temperature Range . . . . .               | $T_J, T_{STG}$ | -40 to 150  | $^\circ\text{C}$    |
| Maximum Lead Temperature for Soldering . . . . .                         | $T_L$          | 260         | $^\circ\text{C}$    |
| Short Circuit Withstand Time (Note 2) at $V_{GE} = 15\text{V}$ . . . . . | $t_{SC}$       | 4           | $\mu\text{s}$       |
| Short Circuit Withstand Time (Note 2) at $V_{GE} = 10\text{V}$ . . . . . | $t_{SC}$       | 13          | $\mu\text{s}$       |

CAUTION: Stresses above those listed in "Absolute Maximum Ratings" may cause permanent damage to the device. This is a stress only rating and operation of the device at these or any other conditions above those indicated in the operational sections of this specification is not implied.

### NOTES:

1. Repetitive Rating: Pulse width limited by maximum junction temperature.
2.  $V_{CE(PK)} = 360\text{V}$ ,  $T_J = 125^\circ\text{C}$ ,  $R_G = 25\Omega$ .

## Electrical Specifications $T_C = 25^\circ\text{C}$ , Unless Otherwise Specified

| PARAMETER                               | SYMBOL        | TEST CONDITIONS  | MIN                        | TYP | MAX       | UNITS         |    |
|---|---------------|--|----------------------------|-----|-----------|---------------|----|
| Collector to Emitter Breakdown Voltage  | $BV_{CES}$    | $I_C = 250\mu\text{A}$ , $V_{GE} = 0\text{V}$  | 600                        | -   | -         | V             |    |
| Emitter to Collector Breakdown Voltage  | $BV_{ECS}$    | $I_C = 10\text{mA}$ , $V_{GE} = 0\text{V}$   | 15                         | 25  | -         | V             |    |
| Collector to Emitter Leakage Current    | $I_{CES}$     | $V_{CE} = BV_{CES}$ , $T_C = 25^\circ\text{C}$   | -                          | -   | 250       | $\mu\text{A}$ |    |
|   |               | $V_{CE} = BV_{CES}$ , $T_C = 150^\circ\text{C}$  | -                          | -   | 2.0       | mA            |    |
| Collector to Emitter Saturation Voltage | $V_{CE(SAT)}$ | $I_C = I_{C110}$ ,<br>$V_{GE} = 15\text{V}$  | $T_C = 25^\circ\text{C}$   | -   | 1.65      | 2.0           | V  |
|   |               |  | $T_C = 150^\circ\text{C}$  | -   | 1.85      | 2.2           | V  |
|   |               | $I_C = 15\text{A}$ ,<br>$V_{GE} = 15\text{V}$  | $T_C = 25^\circ\text{C}$   | -   | 1.80      | 2.2           | V  |
|   |               |  | $T_C = 150^\circ\text{C}$  | -   | 2.0       | 2.4           | V  |
| Gate to Emitter Threshold Voltage       | $V_{GE(TH)}$  | $I_C = 250\mu\text{A}$ ,<br>$V_{CE} = V_{GE}$  | 3.0                        | 5.0 | 6.0       | V             |    |
| Gate to Emitter Leakage Current         | $I_{GES}$     | $V_{GE} = \pm 20\text{V}$  | -                          | -   | $\pm 100$ | nA            |    |
| Switching SOA                           | SSOA          | $T_J = 150^\circ\text{C}$ ,<br>$V_{GE} = 15\text{V}$ ,<br>$R_G = 25\Omega$ ,<br>$L = 100\mu\text{H}$   | $V_{CE(PK)} = 480\text{V}$ | 80  | -         | -             | A  |
|   |               |  | $V_{CE(PK)} = 600\text{V}$ | 24  | -         | -             | A  |
| Gate to Emitter Plateau Voltage         | $V_{GEP}$     | $I_C = I_{C110}$ , $V_{CE} = 0.5 BV_{CES}$   | -                          | 7.6 | -         | V             |    |
| On-State Gate Charge                    | $Q_{G(ON)}$   | $I_C = I_{C110}$ ,<br>$V_{CE} = 0.5 BV_{CES}$  | $V_{GE} = 15\text{V}$      | -   | 48        | 55            | nC |
|   |               |  | $V_{GE} = 20\text{V}$      | -   | 62        | 71            | nC |
| Current Turn-On Delay Time              | $t_{d(ON)I}$  | $T_J = 150^\circ\text{C}$ ,<br>$I_{CE} = I_{C110}$ ,<br>$V_{CE(PK)} = 0.8 BV_{CES}$ ,<br>$V_{GE} = 15\text{V}$ ,<br>$R_G = 25\Omega$ ,<br>$L = 100\mu\text{H}$ | -                          | 14  | -         | ns            |    |
| Current Rise Time                       | $t_{rl}$      |  | -                          | 16  | -         | ns            |    |
| Current Turn-Off Delay Time             | $t_{d(OFF)I}$ |  | -                          | 270 | 400       | ns            |    |
| Current Fall Time                       | $t_{fl}$      |  | -                          | 210 | 275       | ns            |    |
| Turn-On Energy                          | $E_{ON}$      |  | -                          | 380 | -         | $\mu\text{J}$ |    |
| Turn-Off Energy (Note 3)                | $E_{OFF}$     |  | -                          | 900 | -         | $\mu\text{J}$ |    |
| Diode Forward Voltage                   | $V_{EC}$      | $I_{EC} = 12\text{A}$  | -                          | 1.7 | 2.0       | V             |    |

# HGTG12N60C3D

## Electrical Specifications $T_C = 25^\circ\text{C}$ , Unless Otherwise Specified (Continued)

| PARAMETER                   | SYMBOL          | TEST CONDITIONS  | MIN | TYP | MAX | UNITS                     |
|-----------------------------|-----------------|--|-----|-----|-----|---------------------------|
| Diode Reverse Recovery Time | $t_{rr}$        | $I_{EC} = 12\text{A}, dI_{EC}/dt = 100\text{A}/\mu\text{s}$  | -   | 34  | 42  | ns                        |
|                             |                 | $I_{EC} = 1.0\text{A}, dI_{EC}/dt = 100\text{A}/\mu\text{s}$ | -   | 30  | 37  | ns                        |
| Thermal Resistance          | $R_{\theta JC}$ | IGBT   | -   | -   | 1.2 | $^\circ\text{C}/\text{W}$ |
|                             |                 | Diode  | -   | -   | 1.5 | $^\circ\text{C}/\text{W}$ |

NOTE:

- Turn-Off Energy Loss ( $E_{OFF}$ ) is defined as the integral of the instantaneous power loss starting at the trailing edge of the input pulse, and ending at the point where the collector current equals zero ( $I_{CE} = 0\text{A}$ ). The HGTG12N60C3D was tested per JEDEC Standard No. 24-1 Method for Measurement of Power Device Turn-Off Switching Loss. This test method produces the true total Turn-Off Energy Loss. Turn-On losses include diode losses.

## Typical Performance Curves

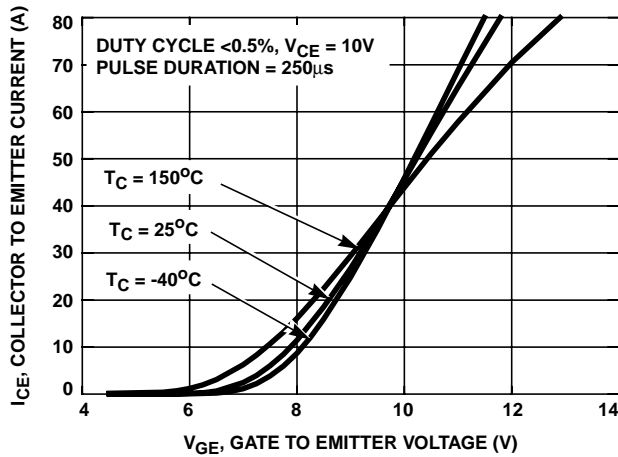

FIGURE 1. TRANSFER CHARACTERISTICS

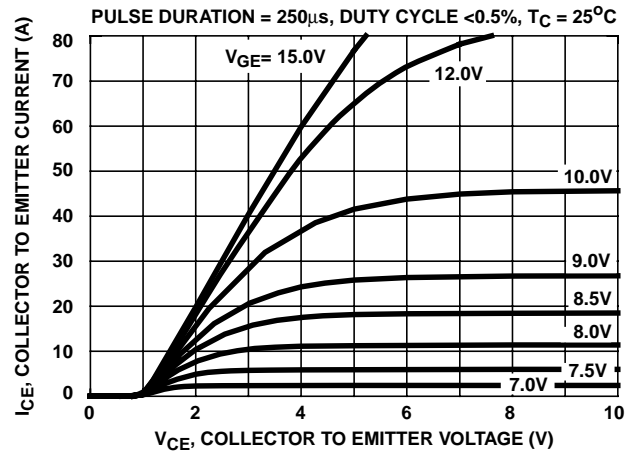

FIGURE 2. SATURATION CHARACTERISTICS

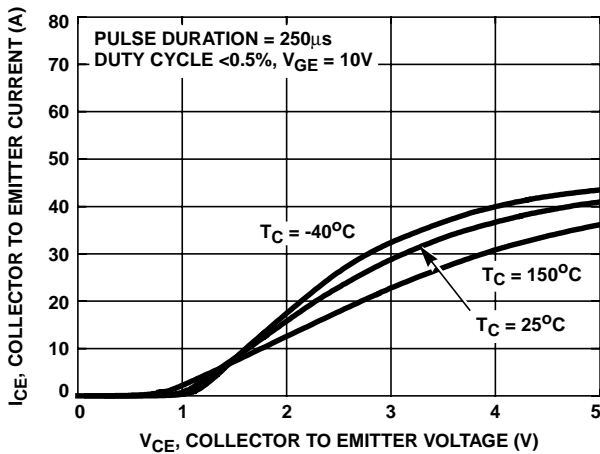

FIGURE 3. COLLECTOR TO EMITTER ON-STATE VOLTAGE

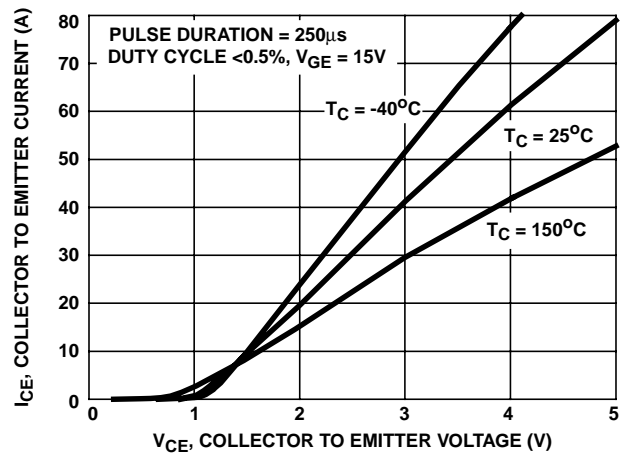

FIGURE 4. COLLECTOR TO EMITTER ON-STATE VOLTAGE

Typical Performance Curves (Continued)

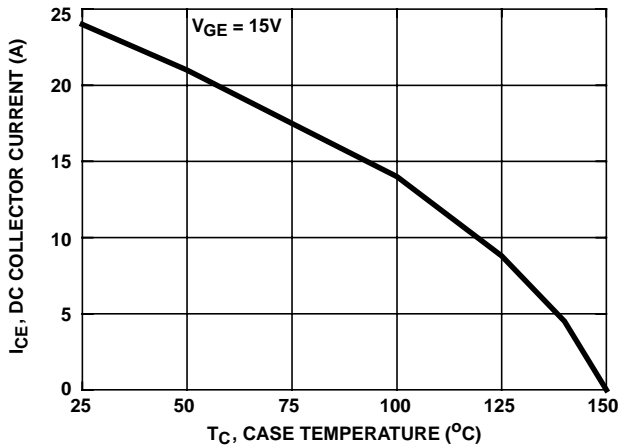

FIGURE 5. MAXIMUM DC COLLECTOR CURRENT vs CASE TEMPERATURE

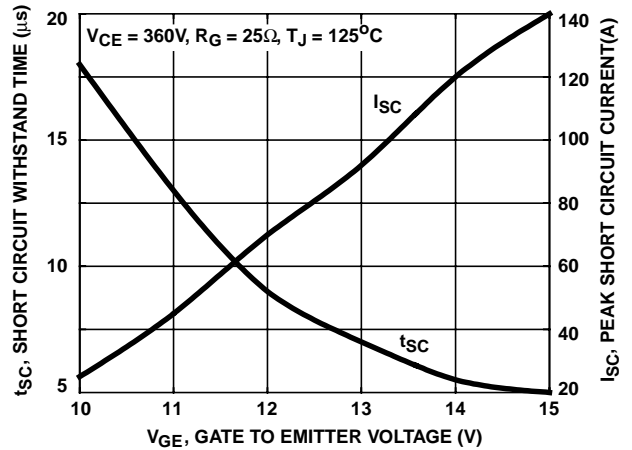

FIGURE 6. SHORT CIRCUIT WITHSTAND TIME

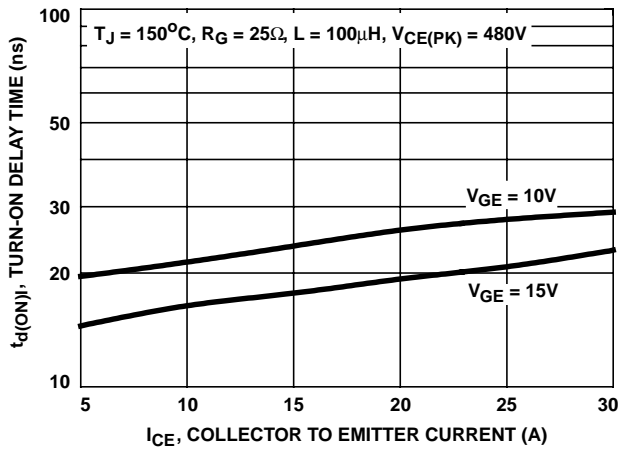

FIGURE 7. TURN-ON DELAY TIME vs COLLECTOR TO EMITTER CURRENT

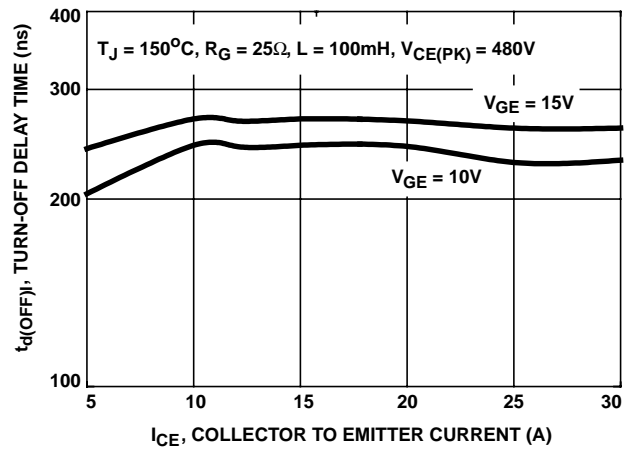

FIGURE 8. TURN-OFF DELAY TIME vs COLLECTOR TO EMITTER CURRENT

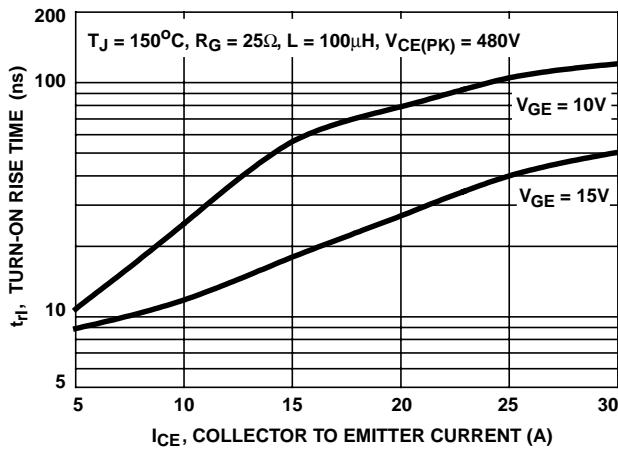

FIGURE 9. TURN-ON RISE TIME vs COLLECTOR TO EMITTER CURRENT

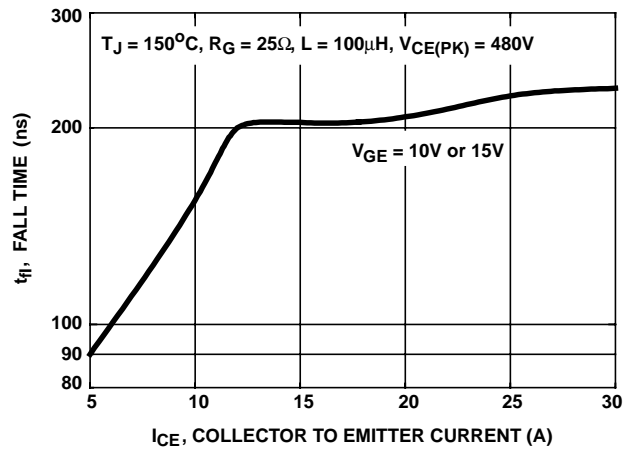

FIGURE 10. TURN-OFF FALL TIME vs COLLECTOR TO EMITTER CURRENT

Typical Performance Curves (Continued)

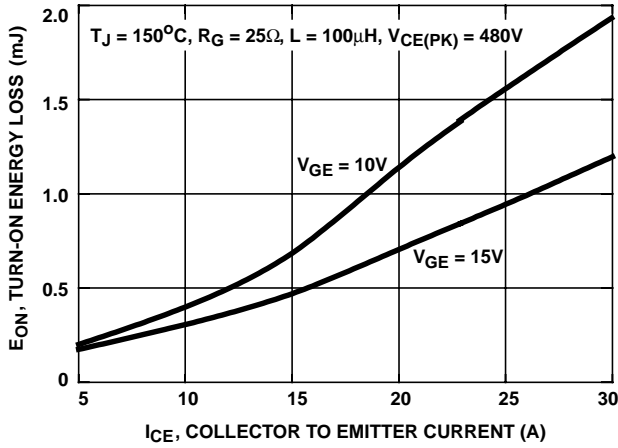

FIGURE 11. TURN-ON ENERGY LOSS vs COLLECTOR TO EMITTER CURRENT

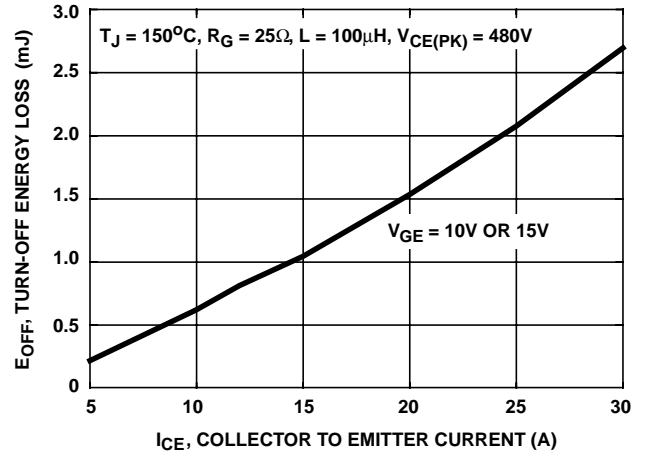

FIGURE 12. TURN-OFF ENERGY LOSS vs COLLECTOR TO EMITTER CURRENT

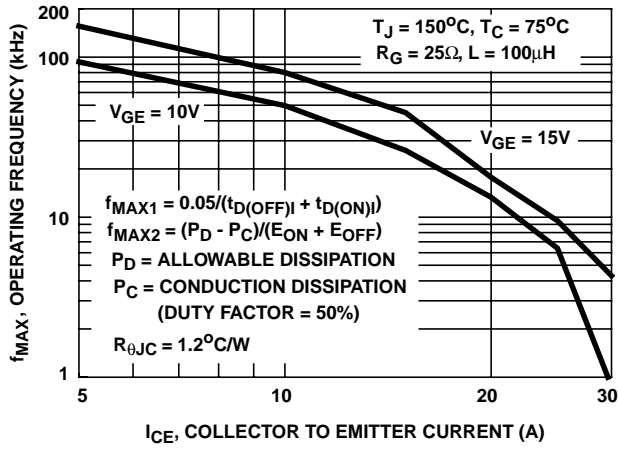

FIGURE 13. OPERATING FREQUENCY vs COLLECTOR TO EMITTER CURRENT

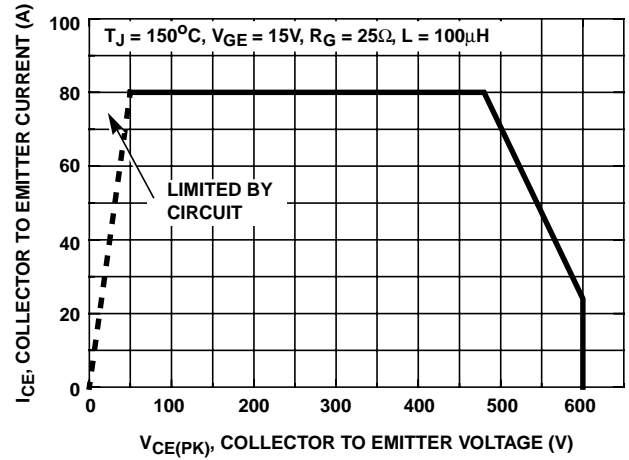

FIGURE 14. SWITCHING SAFE OPERATING AREA

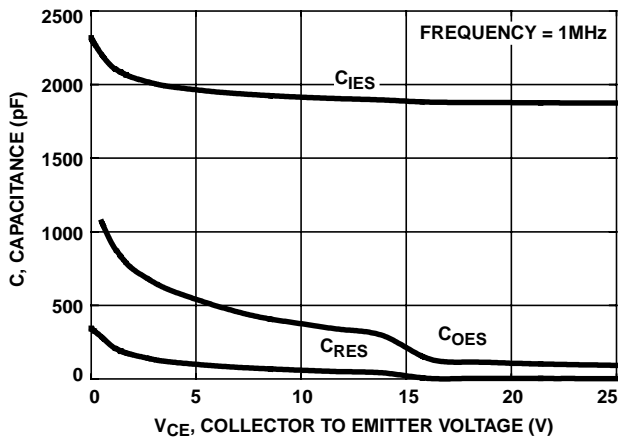

FIGURE 15. CAPACITANCE vs COLLECTOR TO EMITTER VOLTAGE

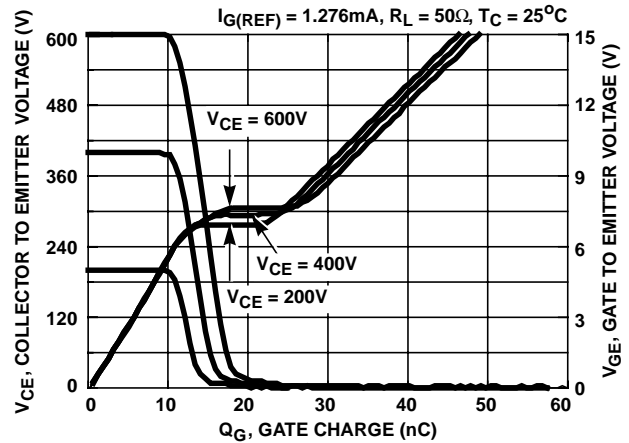

FIGURE 16. GATE CHARGE WAVEFORMS

Typical Performance Curves (Continued)

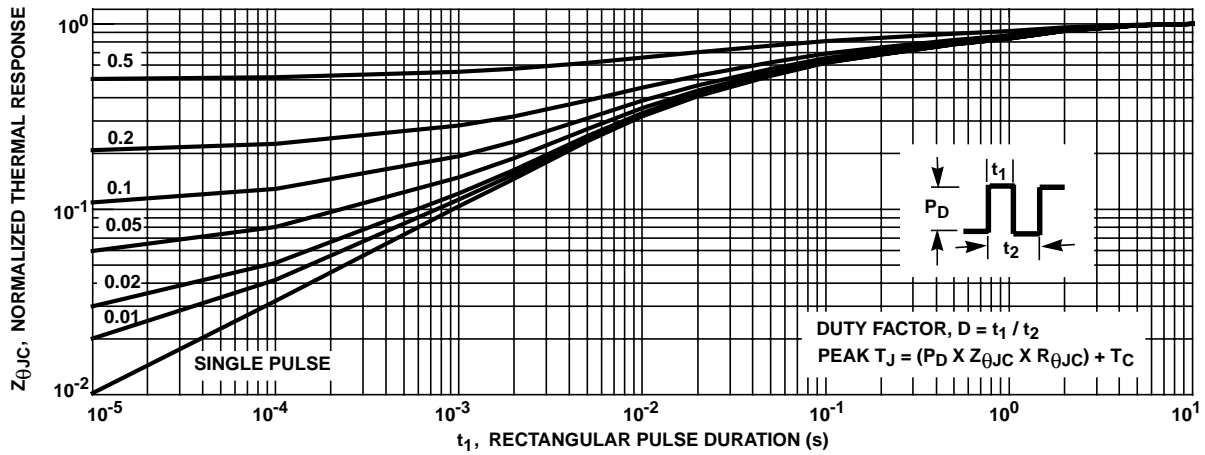

FIGURE 17. IGBT NORMALIZED TRANSIENT THERMAL IMPEDANCE, JUNCTION TO CASE

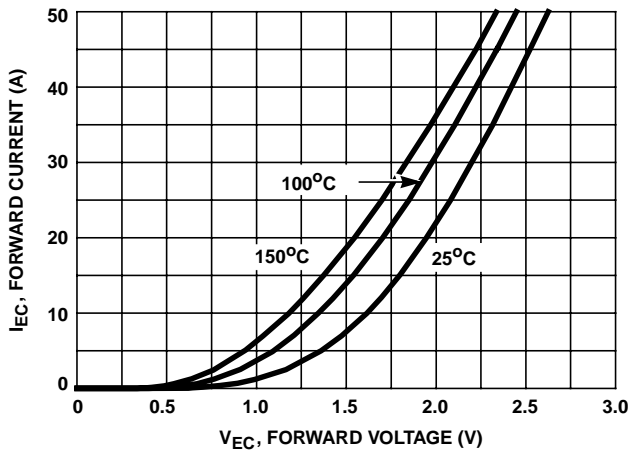

FIGURE 18. DIODE FORWARD CURRENT vs FORWARD VOLTAGE DROP

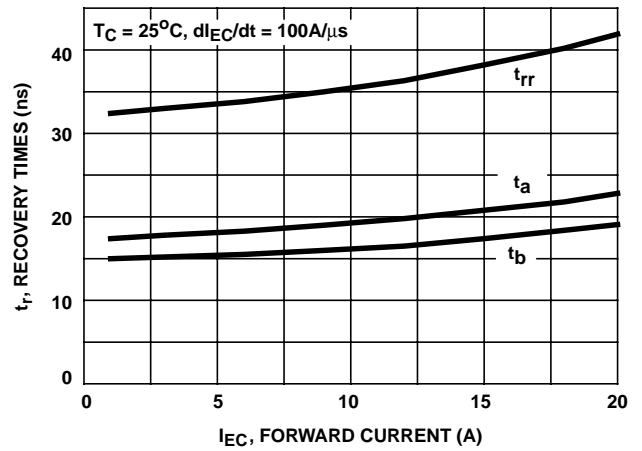

FIGURE 19. RECOVERY TIMES vs FORWARD CURRENT

Test Circuit and Waveform

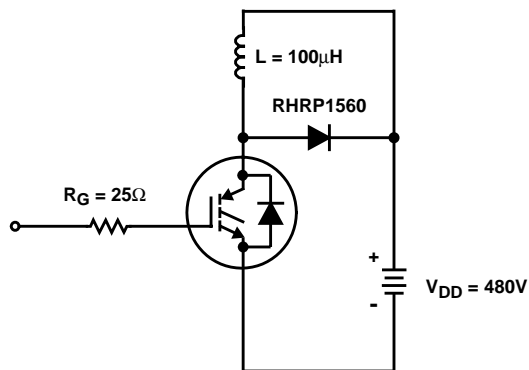

FIGURE 20. INDUCTIVE SWITCHING TEST CIRCUIT

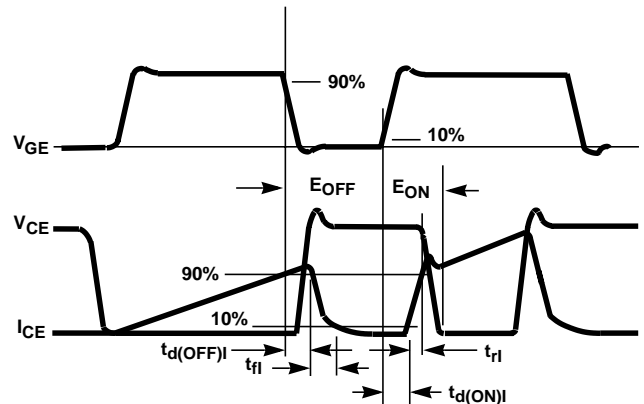

FIGURE 21. SWITCHING TEST WAVEFORMS

## Handling Precautions for IGBTs

Insulated Gate Bipolar Transistors are susceptible to gate-insulation damage by the electrostatic discharge of energy through the devices. When handling these devices, care should be exercised to assure that the static charge built in the handler's body capacitance is not discharged through the device. With proper handling and application procedures, however, IGBTs are currently being extensively used in production by numerous equipment manufacturers in military, industrial and consumer applications, with virtually no damage problems due to electrostatic discharge. IGBTs can be handled safely if the following basic precautions are taken:

1. Prior to assembly into a circuit, all leads should be kept shorted together either by the use of metal shorting springs or by the insertion into conductive material such as "ECCOSORBD™ LD26" or equivalent.
2. When devices are removed by hand from their carriers, the hand being used should be grounded by any suitable means, for example, with a metallic wristband.
3. Tips of soldering irons should be grounded.
4. Devices should never be inserted into or removed from circuits with power on.
5. **Gate Voltage Rating** - Never exceed the gate-voltage rating of  $V_{GEM}$ . Exceeding the rated  $V_{GE}$  can result in permanent damage to the oxide layer in the gate region.
6. **Gate Termination** - The gates of these devices are essentially capacitors. Circuits that leave the gate open-circuited or floating should be avoided. These conditions can result in turn-on of the device due to voltage buildup on the input capacitor due to leakage currents or pickup.
7. **Gate Protection** - These devices do not have an internal monolithic Zener Diode from gate to emitter. If gate protection is required an external Zener is recommended.

## Operating Frequency Information

Operating frequency information for a typical device (Figure 13) is presented as a guide for estimating device performance for a specific application. Other typical frequency vs collector current ( $I_{CE}$ ) plots are possible using the information shown for a typical unit in Figures 4, 7, 8, 11 and 12. The operating frequency plot (Figure 13) of a typical device shows  $f_{MAX1}$  or  $f_{MAX2}$  whichever is smaller at each point. The information is based on measurements of a typical device and is bounded by the maximum rated junction temperature.

$f_{MAX1}$  is defined by  $f_{MAX1} = 0.05 / (t_{D(OFF)I} + t_{D(ON)I})$ . Deadtime (the denominator) has been arbitrarily held to 10% of the on-state time for a 50% duty factor. Other definitions are possible.  $t_{D(OFF)I}$  and  $t_{D(ON)I}$  are defined in Figure 21.

Device turn-off delay can establish an additional frequency limiting condition for an application other than  $T_{JM}$ .  $t_{D(OFF)I}$  is important when controlling output ripple under a lightly loaded condition.

$f_{MAX2}$  is defined by  $f_{MAX2} = (P_D - P_C) / (E_{OFF} + E_{ON})$ . The allowable dissipation ( $P_D$ ) is defined by  $P_D = (T_{JM} - T_C) / R_{\theta JC}$ . The sum of device switching and conduction losses must not exceed  $P_D$ . A 50% duty factor was used (Figure 13) and the conduction losses ( $P_C$ ) are approximated by  $P_C = (V_{CE} \times I_{CE}) / 2$ .

$E_{ON}$  and  $E_{OFF}$  are defined in the switching waveforms shown in Figure 21.  $E_{ON}$  is the integral of the instantaneous power loss ( $I_{CE} \times V_{CE}$ ) during turn-on and  $E_{OFF}$  is the integral of the instantaneous power loss during turn-off. All tail losses are included in the calculation for  $E_{OFF}$ ; i.e. the collector current equals zero ( $I_{CE} = 0$ ).

All Intersil semiconductor products are manufactured, assembled and tested under **ISO9000** quality systems certification.

*Intersil semiconductor products are sold by description only. Intersil Corporation reserves the right to make changes in circuit design and/or specifications at any time without notice. Accordingly, the reader is cautioned to verify that data sheets are current before placing orders. Information furnished by Intersil is believed to be accurate and reliable. However, no responsibility is assumed by Intersil or its subsidiaries for its use; nor for any infringements of patents or other rights of third parties which may result from its use. No license is granted by implication or otherwise under any patent or patent rights of Intersil or its subsidiaries.*

For information regarding Intersil Corporation and its products, see web site [www.intersil.com](http://www.intersil.com)