

FEATURES

- 2.5 Gb/s Differential Output TIA
- Low Group Delay
- Single +5V Power Supply
- Small Size: 0.864mm x 1.014mm
- 300mW (typ) Power Dissipation

APPLICATIONS

- SONET/SDH OC-48/STM-16
- 2.5Gb/s DWDM
- Fiber optic receivers, transceivers and transponders

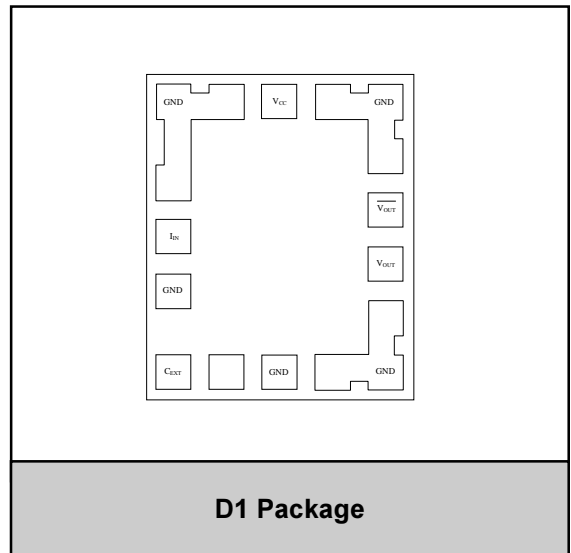

PRODUCT DESCRIPTION

The Anadigics ATA7550D1 is a high-speed 5V transimpedance amplifier (TIA) available in bare die form and manufactured using an InGaP based HBT process. The device is used in conjunction with a

photodetector to convert an optical signal into a differential output voltage. With its low group delay, the ATA7550 is ideally suited for DWDM applications.

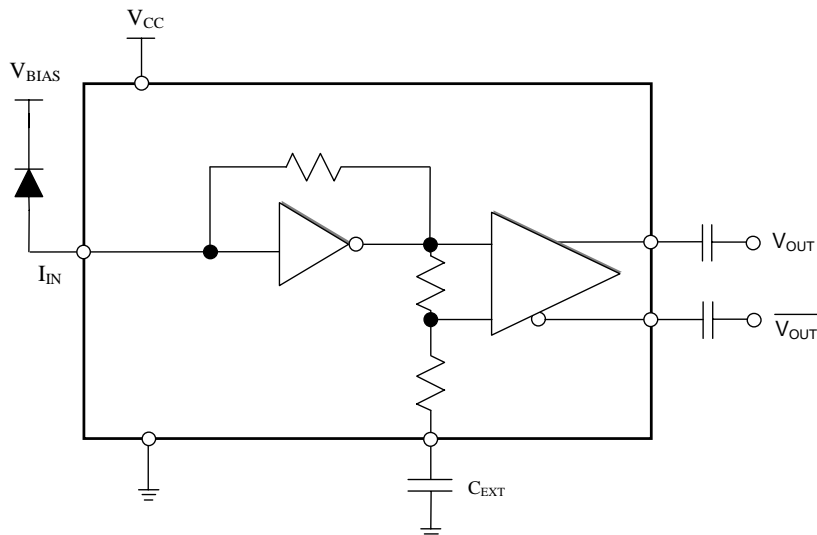

Figure 1: Circuit Block Diagram

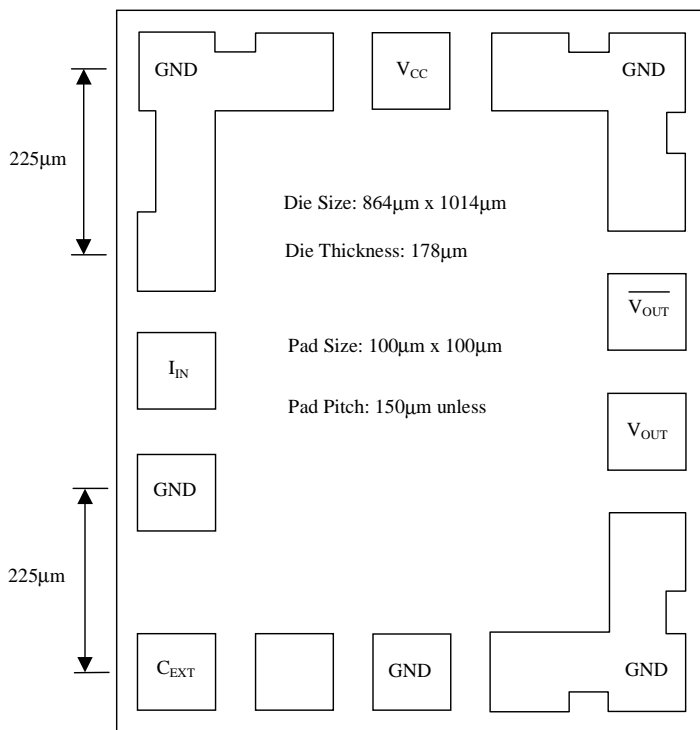

Figure 2: Die Size and Layout

Table 1: Pad Description

PAD	DESCRIPTION	COMMENT
V _{CC}	Positive Supply Voltage	+5.0V
I _{IN}	TIA Input	Photocurrent input
C _{EXT}	Connection for an external Capacitor	Sets the low frequency cutoff
V _{OUT}	TIA Output Voltage (Non-inverted)	Logical '1' with optical input
V _{OUT} ̄	TIA Output Voltage (inverted)	Logical '0' with optical input

ELECTRICAL CHARACTERISTICS

Table 2: Absolute Maximum Ratings

V_{CC}	7.0V
I_{IN}	3mApp
T_S	Storage Temp -65 °C to 125 °C

Stresses in excess of the absolute ratings may cause permanent damage. Functional operation is not implied under these conditions. Exposure to absolute ratings for extended periods of time may adversely affect reliability.

Table 3: Recommended Operating Conditions

PARAMETER	MIN	TYP	MAX	UNIT
Operating Voltage Range	+4.75	+5.0	+5.25	V
Operating Temperature Range ⁽¹⁾	-10		70	°C
Die Attach Temperature			260	°C

The device may be operated safely over these conditions; however, parametric performance is guaranteed only over the conditions defined in the electrical specifications.

1. Defined at the interface between the die and the substrate.

Table 4: DC Electrical Specifications

PARAMETER	MIN	TYP	MAX	UNIT
Input Offset Voltage		2.6		V
Output Offset Voltage		3.5		V
Supply Current		60	80	mA
Power Dissipation		300	420	mW

Table 5: AC Electrical Specifications ⁽²⁾

PARAMETER	MIN	TYP	MAX	UNIT
Small Signal Differential Transresistance (RL - 100Ω)	1500	2000		Ω
Bandwidth (-3dB)	1600	1900		MHz
Low Frequency Cutoff ⁽³⁾		30		kHz
Group Delay (1MHz to 1.7GHz; I _{IN} < 250μApp)		±30		ps
Optical Sensitivity ⁽⁴⁾		-23		dBm
Input Noise Current (RMS) ⁽⁵⁾			800	nA
Optical Overload ⁽⁴⁾	-3	-1		dBm
Input Current at which Output Limits ⁽⁶⁾		250		μA
Single-Ended Output Voltage (I _{IN} = 20μApp)	15	20		mVpp
Maximum Differential Output Voltage			500	mVpp
Output Return Loss (1MHz to 10GHz)	10			B

Notes:

- The specifications are based upon the use of a PIN photodetector with a responsivity at 1310nm of 0.9A/W (typical) and a capacitance of $C_{DIODE} + C_{STRAY} = 0.5pF$ max connected to I_{IN} via a 1nH bond wire.
- With the use of an external capacitor.
- Measured at 10⁻¹⁰ BER with a 2²³ -1 PRBS at 2.488Gb/s.
- 1.9 GHz bandwidth.
- Defined as 80% of the maximum output voltage.

PERFORMANCE DATA

Figure 3: External Capacitor Required for Low Frequency Cutoff

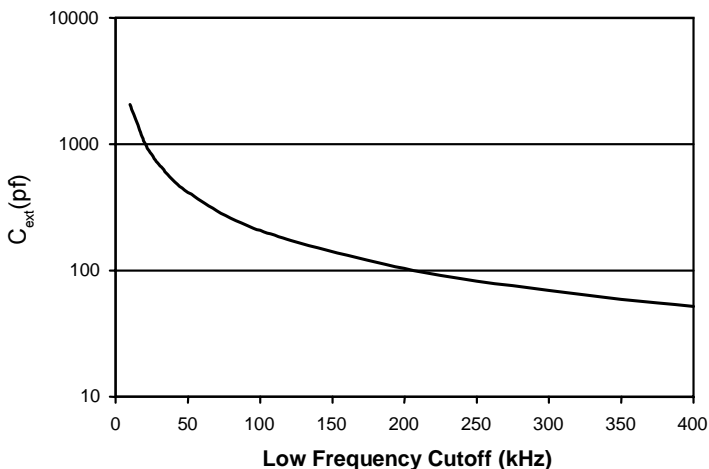

Figure 4: Differential Output Voltage vs. Input Current

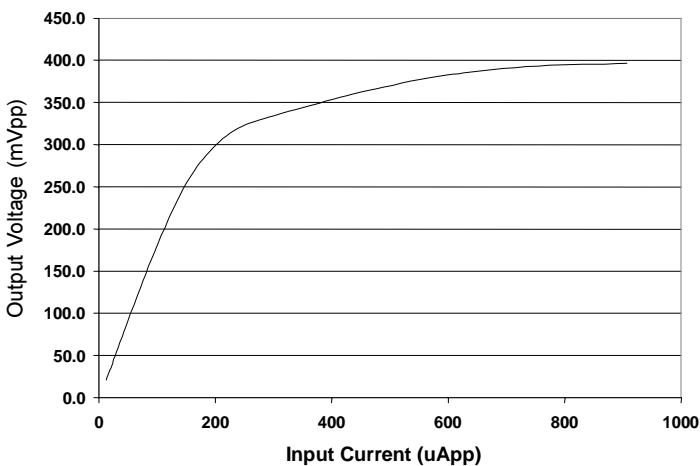

Figure 5: Eye Diagram with an Optical Input Power of -20dBm

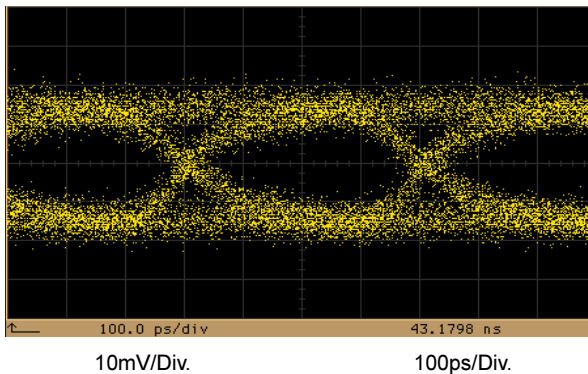

Figure 6: Eye Diagram with an Optical Input Power of -15dBm

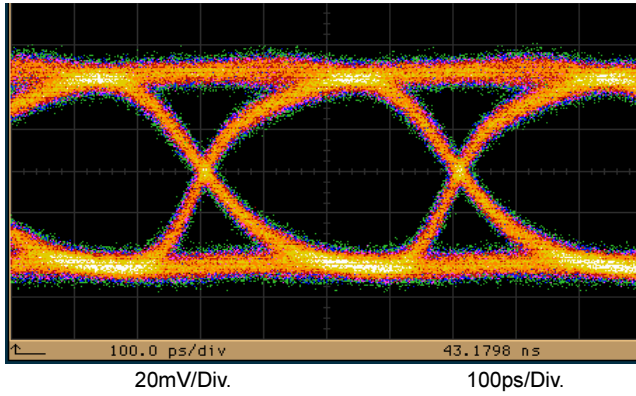

Figure 7: Eye Diagram with an Optical Input Power of -5dBm

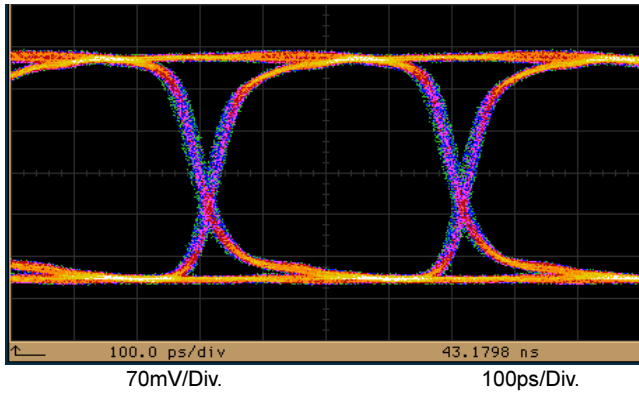
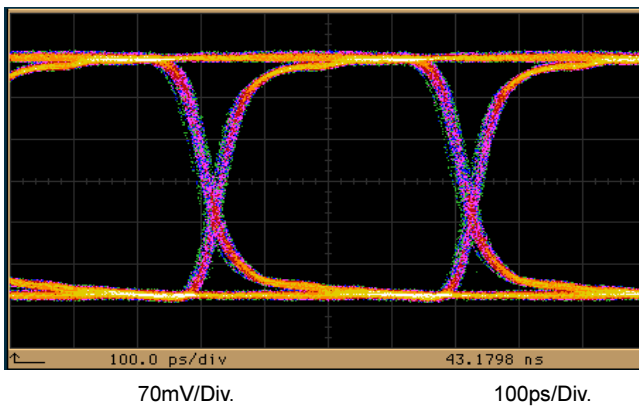

Figure 8: Eye Diagram with an Optical Input Power of -2dBm



APPLICATION INFORMATION

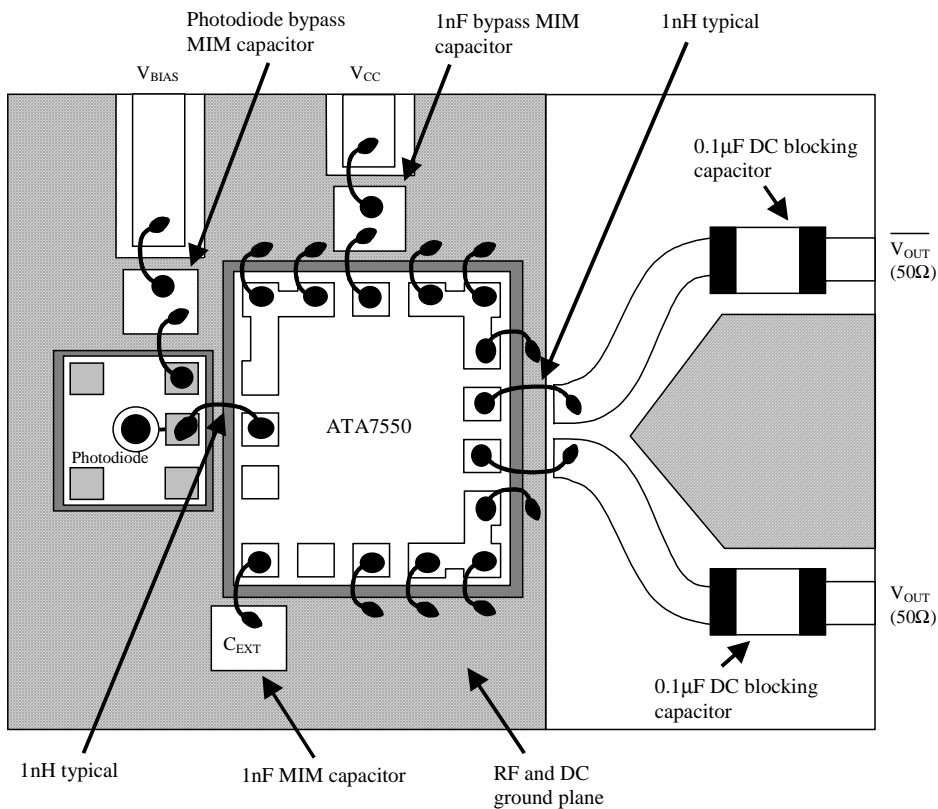

Figure 9: Bonding Diagram

Packaging

The ATA7550D1 is provided as bare die. For optimum performance, the die should be packaged in a hermetic enclosure and a low inductance ground plane should be made available for power supply bypassing and ground bonds. When packaging the ATA7550D1, the temperature of the die must be kept below 260°C to ensure the device reliability. The ATA7550D1 does not have backside metal and must be epoxy mounted. A good thermally conductive, silver filled epoxy is recommended for epoxy mounting. A soft silicon/rubber tip collet or pyramidal collet should be used for die mounting, although tweezers can be used with extreme care.

Thermosonic ball bonding, at a stage temperature of 150 to 175°C with 1 to 1.3 mil gold wire, is the recommended interconnect technique. The bond force, time and ultrasonic power are all critical parameters and may require optimization to achieve the correct bond without causing bonding pad delamination or damage under the bonding pad.

The bond wire from the photodetector to I_{IN} should be made as short as possible. As the inductance of this connection increases beyond 1nH, more gain peaking will occur and the group delay performance will degrade.

Output Connections

The ATA7550D1 provides a differential output that must be AC coupled to the next stage of the receiver as the output buffer is not designed to drive a DC coupled 50Ω load. For single-ended applications, one output of the ATA7550D1 must be AC terminated to a 50Ω load.

C_{EXT} Connection

In order to achieve the desired low frequency cutoff, an external capacitor is required. A low inductance surface mount chip capacitor or MIM capacitor is recommended.

Sensitivity Measurement

The typical sensitivity, as specified in the AC characteristics, is -23dBm. This was measured at a BER of 10⁻¹⁰ with a 2.5Gb/s, 2²³-1 PRBS, using a

lensed single mode fiber with the photodetector and TIA in an open test fixture under the following conditions:

Photodetector active area: 50μm
Photodetector capacitance: 0.3pF
Photodetector responsivity: 0.90A/W
Lensed fiber beam width: 13μm (86.5% of contained power)
Lensed fiber focal distance: 3mm

When the photodetector and TIA are packaged in a hermetic enclosure, with the fiber optimally aligned to the active area of the photodiode, an improvement in sensitivity should be observed.

NOTES

ATA7550

NOTES

NOTES

ORDERING INFORMATION

PART NUMBER	PACKAGE OPTION	PACKAGE DESCRIPTION
ATA7550D1	D1	Die



ANADIGICS, Inc.

141 Mount Bethel Road

Warren, New Jersey 07059, U.S.A

Tel: +1 (908) 668-5000

Fax: +1 (908) 668-5132

<http://www.anadigics.com>

Mktg@anadigics.com

IMPORTANT NOTICE

ANADIGICS, Inc. reserves the right to make changes to its products or to discontinue any product at any time without notice. The product specifications contained in Advanced Product Information sheets and Preliminary Data Sheets are subject to change prior to a product's formal introduction. Information in Data Sheets have been carefully checked and are assumed to be reliable; however, ANADIGICS assumes no responsibilities for inaccuracies. ANADIGICS strongly urges customers to verify that the information they are using is current before placing orders.

WARNING

ANADIGICS products are not intended for use in life support appliances, devices, or systems. Use of an ANADIGICS product in any such application without written consent is prohibited.