2SK1521, 2SK1522

Silicon N-Channel MOS FET

HITACHI

November 1996

Application

High speed power switching

Features

- Low on-resistance
- High speed switching
- Low drive current
- Built-in fast recovery diode ($t_r = 120$ ns)
- Suitable for motor control, switching regulator, DC-DC converter

Outline

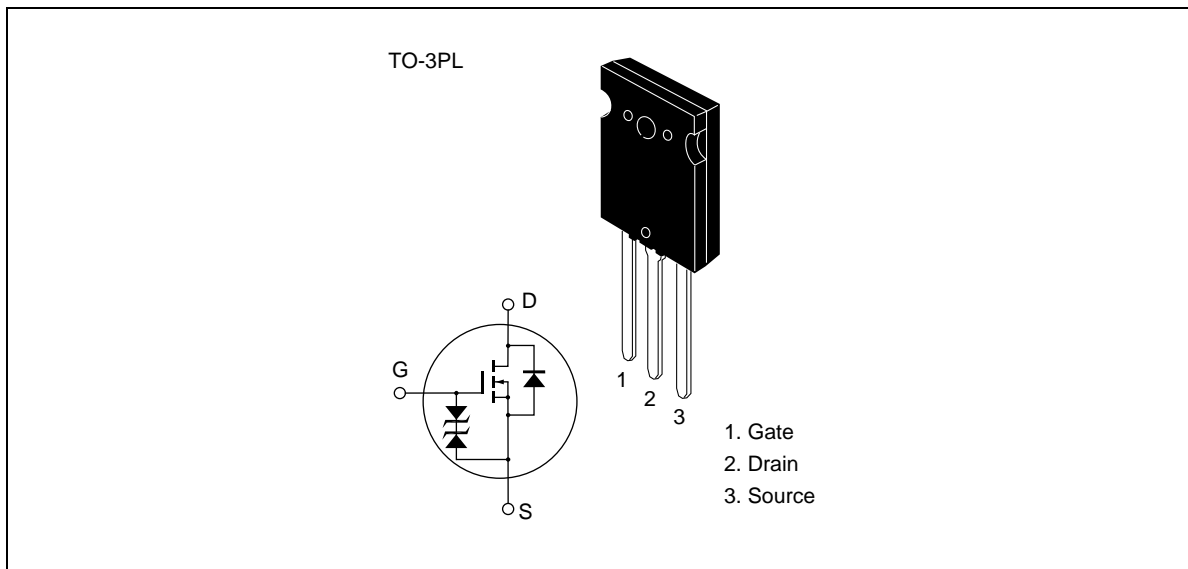

2SK1521, 2SK1522

Absolute Maximum Ratings (Ta = 25°C)

Item		Symbol	Ratings	Unit
Drain to source voltage	2SK1521	V_{DSS}	450	V
	2SK1522		500	
Gate to source voltage		V_{GSS}	±30	V
Drain current		I_D	50	A
Drain peak current		$I_{D(pulse)}^{*1}$	200	A
Body to drain diode reverse drain current		I_{DR}	50	A
Channel dissipation		Pch^{*2}	250	W
Channel temperature		Tch	150	°C
Storage temperature		Tstg	-55 to +150	°C

- Note 1. $PW \leq 10 \mu s$, duty cycle $\leq 1\%$
2. Value at $T_c = 25^\circ C$

2SK1521, 2SK1522

Electrical Characteristics (Ta = 25°C)

Item	Symbol	Min	Typ	Max	Unit	Test conditions
Drain to source breakdown voltage	2SK1521 $V_{(BR)DSS}$ 2SK1522	450	—	—	V	$I_D = 10 \text{ mA}$, $V_{GS} = 0$
Gate to source breakdown voltage	$V_{(BR)GSS}$	±30	—	—	V	$I_G = \pm 100 \mu\text{A}$, $V_{DS} = 0$
Gate to source leak current	I_{GSS}	—	—	±10	μA	$V_{GS} = \pm 25 \text{ V}$, $V_{DS} = 0$
Zero gate voltage drain current	2SK1521 I_{DSS} 2SK1522	—	—	250	μA	$V_{DS} = 360 \text{ V}$, $V_{GS} = 0$ $V_{DS} = 400 \text{ V}$, $V_{GS} = 0$
Gate to source cutoff voltage	$V_{GS(off)}$	2.0	—	3.0	V	$I_D = 1 \text{ mA}$, $V_{DS} = 10 \text{ V}$
Static Drain to source on state resistance	2SK1521 $R_{DS(on)}$ 2SK1522	—	0.08	0.10	Ω	$I_D = 25 \text{ A}$, $V_{GS} = 10 \text{ V}^{*1}$
Forward transfer admittance	yfs	22	35	—	S	$I_D = 25 \text{ A}$, $V_{DS} = 10 \text{ V}^{*1}$
Input capacitance	Ciss	—	8700	—	pF	$V_{DS} = 10 \text{ V}$, $V_{GS} = 0$,
Output capacitance	Coss	—	2400	—	pF	f = 1 MHz
Reverse transfer capacitance	Crss	—	235	—	pF	
Turn-on delay time	$t_{d(on)}$	—	85	—	ns	$I_D = 25 \text{ A}$, $V_{GS} = 10 \text{ V}$,
Rise time	t_r	—	250	—	ns	$R_L = 1.2 \Omega$
Turn-off delay time	$t_{d(off)}$	—	600	—	ns	
Fall time	t_f	—	250	—	ns	
Body to drain diode forward voltage	V_{DF}	—	1.1	—	V	$I_F = 50 \text{ A}$, $V_{GS} = 0$
Body to drain diode reverse recovery time	t_{rr}	—	120	—	ns	$I_F = 50 \text{ A}$, $V_{GS} = 0$, $di_F/dt = 100 \text{ A}/\mu\text{s}$

Note 1. Pulse test

2SK1521, 2SK1522

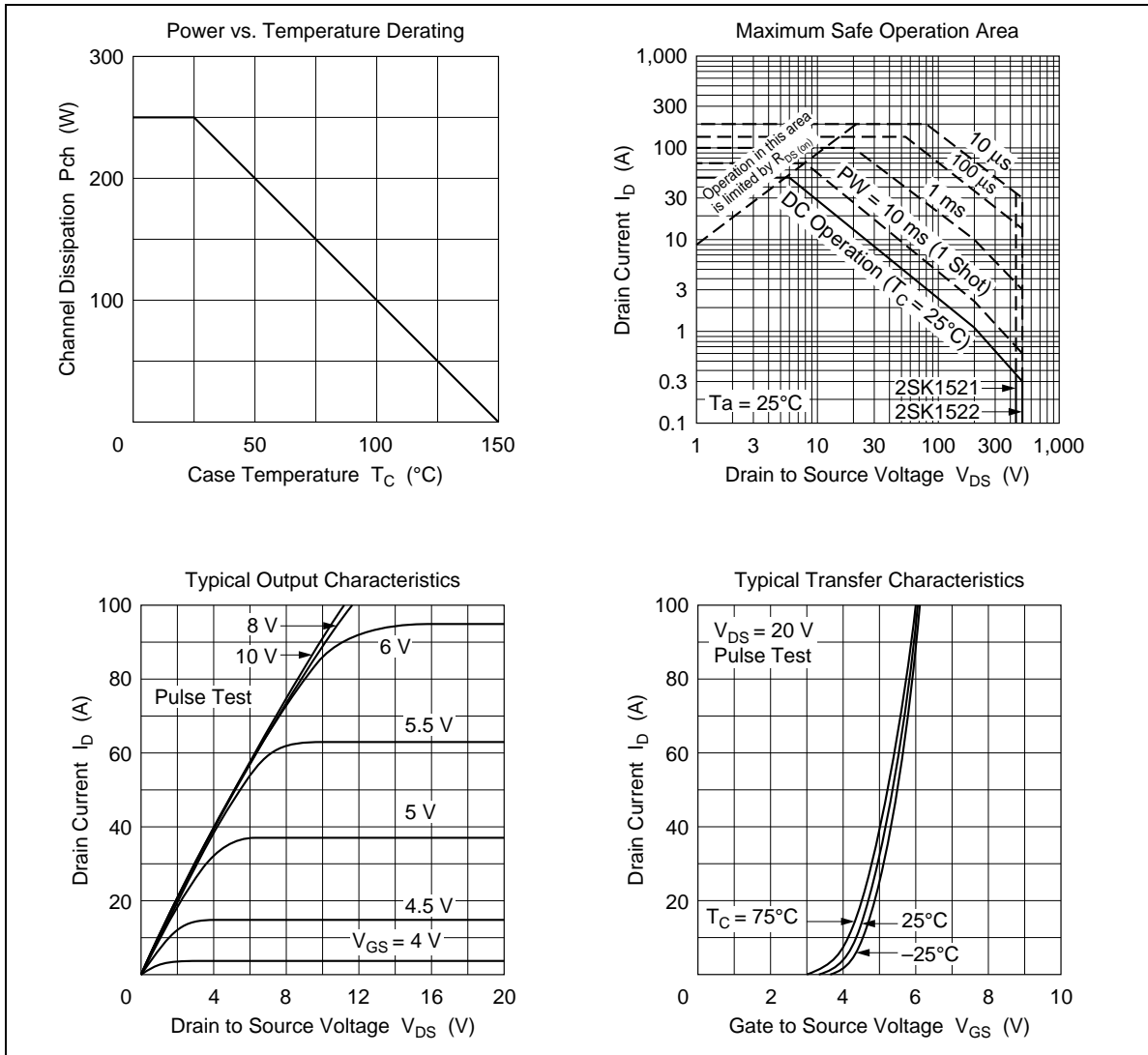

HITACHI

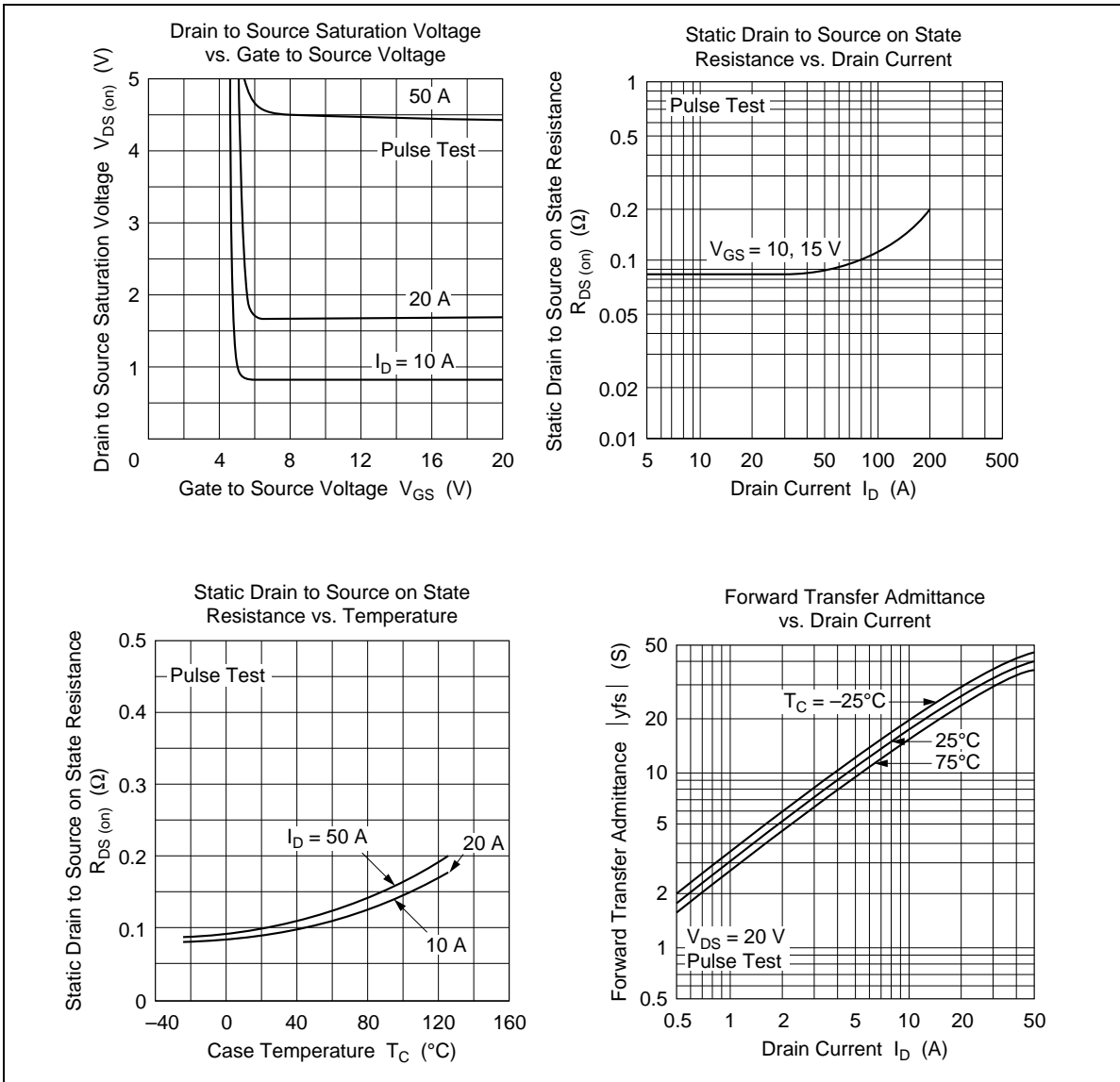

2SK1521, 2SK1522

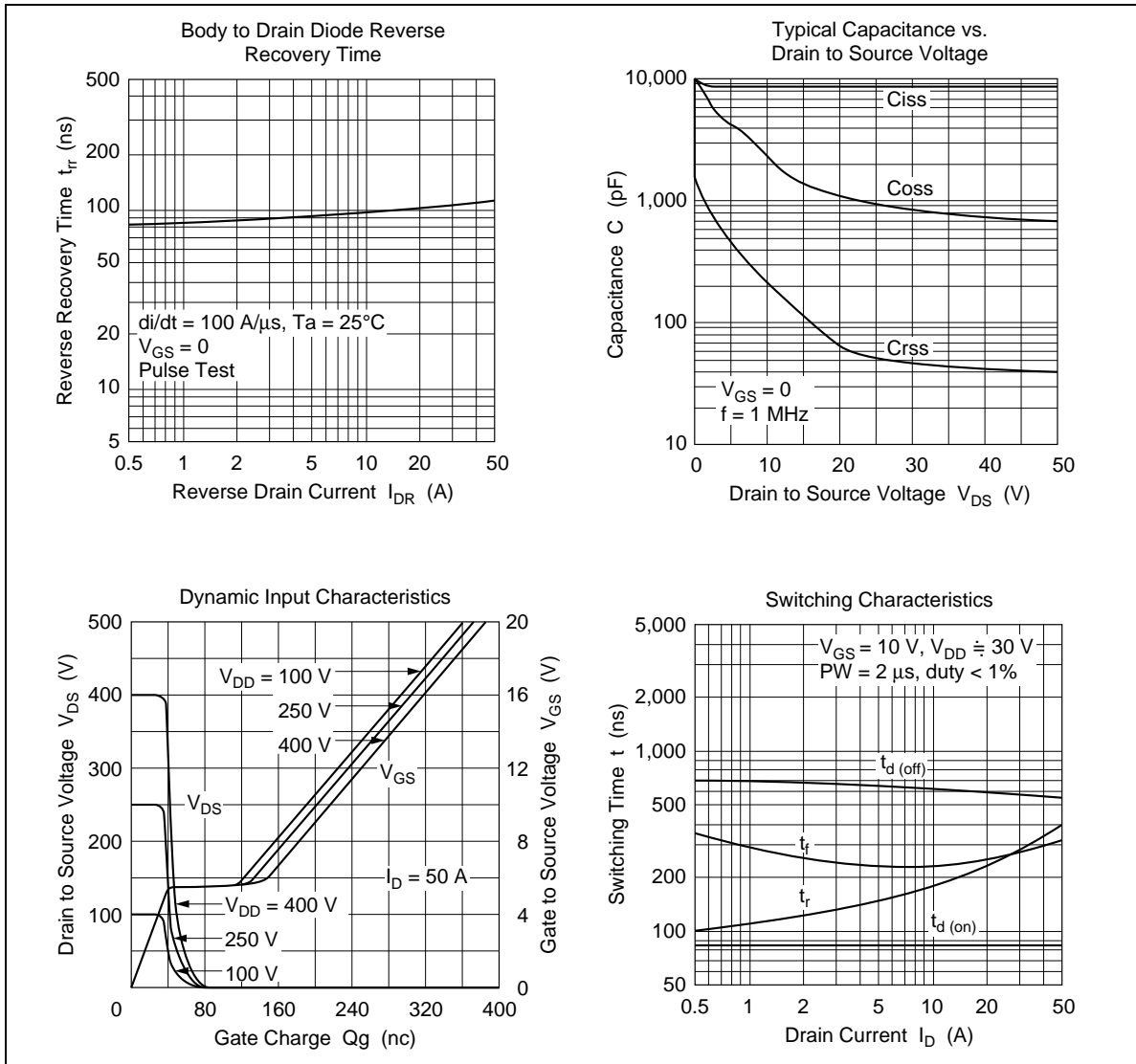

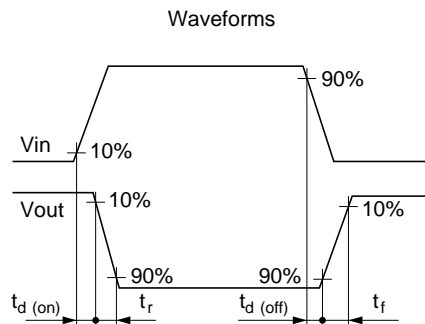
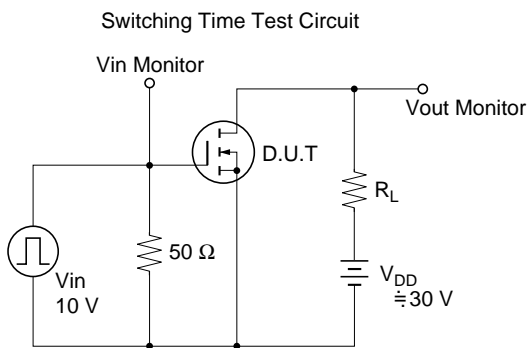
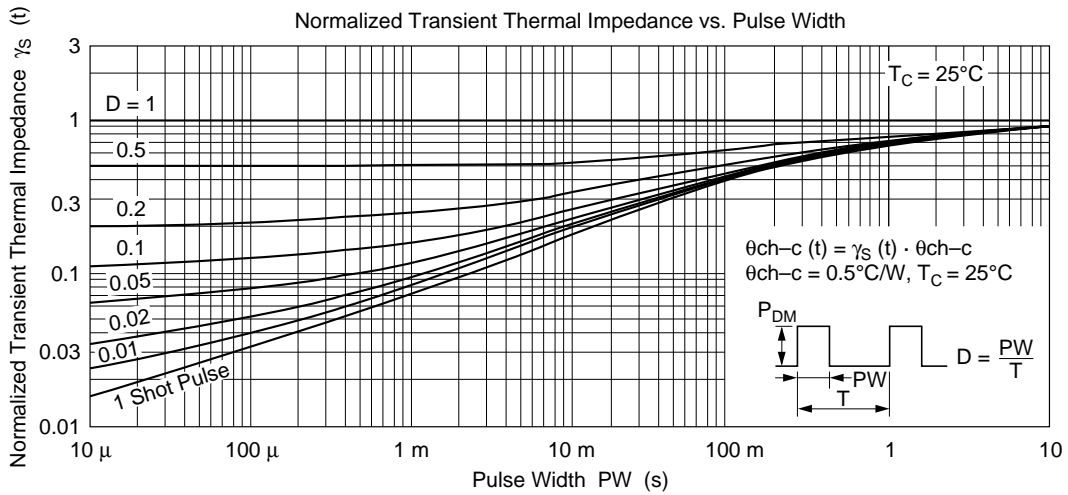
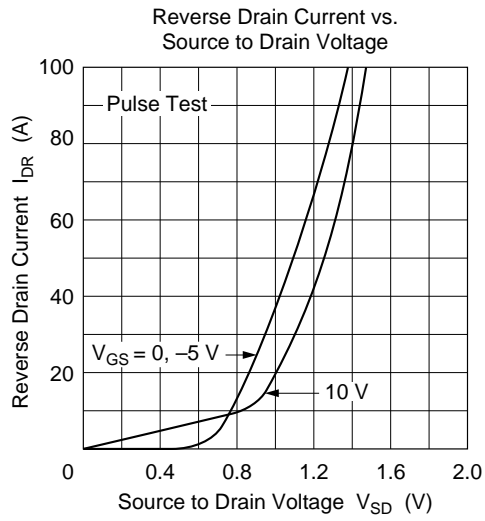

Notice

When using this document, keep the following in mind:

1. This document may, wholly or partially, be subject to change without notice.
2. All rights are reserved: No one is permitted to reproduce or duplicate, in any form, the whole or part of this document without Hitachi's permission.
3. Hitachi will not be held responsible for any damage to the user that may result from accidents or any other reasons during operation of the user's unit according to this document.
4. Circuitry and other examples described herein are meant merely to indicate the characteristics and performance of Hitachi's semiconductor products. Hitachi assumes no responsibility for any intellectual property claims or other problems that may result from applications based on the examples described herein.
5. No license is granted by implication or otherwise under any patents or other rights of any third party or Hitachi, Ltd.
6. **MEDICAL APPLICATIONS:** Hitachi's products are not authorized for use in **MEDICAL APPLICATIONS** without the written consent of the appropriate officer of Hitachi's sales company. Such use includes, but is not limited to, use in life support systems. Buyers of Hitachi's products are requested to notify the relevant Hitachi sales offices when planning to use the products in **MEDICAL APPLICATIONS**.

HITACHI

Hitachi, Ltd.

Semiconductor & IC Div.
Nippon Bldg., 2-6-2, Ohte-machi, Chiyoda-ku, Tokyo 100, Japan
Tel: Tokyo (03) 3270-2111
Fax: (03) 3270-5109

For further information write to:

Hitachi America, Ltd.
Semiconductor & IC Div.
2000 Sierra Point Parkway
Brisbane, CA. 94005-1835
U S A
Tel: 415-589-8300
Fax: 415-583-4207

Hitachi Europe GmbH
Electronic Components Group
Continental Europe
Dornacher Straße 3
D-85622 Feldkirchen
München
Tel: 089-9 91 80-0
Fax: 089-9 29 30 00

Hitachi Europe Ltd.
Electronic Components Div.
Northern Europe Headquarters
Whitebrook Park
Lower Cookham Road
Maidenhead
Berkshire SL6 8YA
United Kingdom
Tel: 0628-585000
Fax: 0628-778322

Hitachi Asia Pte. Ltd.
16 Collyer Quay #20-00
Hitachi Tower
Singapore 0104
Tel: 535-2100
Fax: 535-1533

Hitachi Asia (Hong Kong) Ltd.
Unit 706, North Tower,
World Finance Centre,
Harbour City, Canton Road
Tsim Sha Tsui, Kowloon
Hong Kong
Tel: 27359218
Fax: 27306071

HITACHI