

Cascadable Silicon Bipolar MMIC Amplifier

Technical Data

MSA-0505

Features

- **Cascadable 50 Ω Gain Block**
- **High Output Power:**
18.0 dBm Typical $P_{1\text{ dB}}$ at 1.0 GHz
- **Low Distortion:**
29.0 dBm Typical IP_3 at 1.0 GHz
- **7.0 dB Typical Gain at 1.0 GHz**
- **Surface Mount Plastic Package**
- **Tape-and-Reel Packaging Option Available⁽¹⁾**

Note:

1. Refer to PACKAGING section "Tape-and-Reel Packaging for Semiconductor Devices."

Description

The MSA-0505 is a high performance medium power silicon bipolar Monolithic Microwave Integrated Circuit (MMIC) housed in a low cost, surface mount package. This MMIC is designed for use as a general purpose 50 Ω gain block. Typical applications include narrow and broad band IF and RF amplifiers in commercial systems.

The MSA-series is fabricated using HP's 10 GHz f_T , 25 GHz f_{MAX} , silicon bipolar MMIC process which uses nitride self-alignment, ion implantation, and gold metallization to achieve excellent performance, uniformity and reliability. The use of an external bias resistor for temperature and current stability also allows bias flexibility.

05 Plastic Package

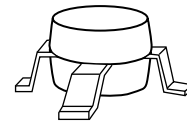

Typical Biasing Configuration

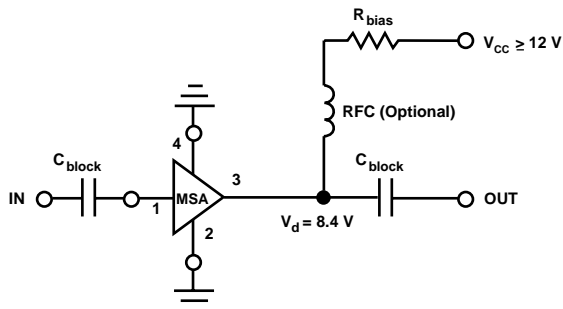

MSA-0505 Absolute Maximum Ratings

Parameter	Absolute Maximum ^[1]
Device Current	135 mA
Power Dissipation ^[2,3]	1.5 W
RF Input Power	+25 dBm
Junction Temperature	200°C
Storage Temperature	-65 to 150°C

Thermal Resistance^[2,4]:

$$\theta_{jc} = 85^{\circ}\text{C/W}$$

Notes:

1. Permanent damage may occur if any of these limits are exceeded.
2. $T_{\text{CASE}} = 25^{\circ}\text{C}$.
3. Derate at 11.8 mW/°C for $T_{\text{C}} > 73^{\circ}\text{C}$.
4. See MEASUREMENTS section "Thermal Resistance" for more information.

Electrical Specifications^[1], $T_{\text{A}} = 25^{\circ}\text{C}$

Symbol	Parameters and Test Conditions: $I_{\text{d}} = 80 \text{ mA}$, $Z_{\text{o}} = 50 \Omega$	Units	Min.	Typ.	Max.
P ₁ dB	Output Power at 1 dB Gain Compression	f = 0.5 GHz		19.0	
		f = 1.0 GHz	16.0	18.0	
G _P	Power Gain ($ S_{21} ^2$)	f = 0.5 GHz		7.5	
		f = 1.0 GHz	6.0	7.0	
ΔG_{P}	Gain Flatness	f = 0.1 to 1.5 GHz		± 0.75	
f ₃ dB	3 dB Bandwidth ^[2]			2.3	
VSWR	Input VSWR	f = 0.1 to 1.5 GHz		1.6:1	
	Output VSWR	f = 0.1 to 1.5 GHz		2.0:1	
IP ₃	Third Order Intercept Point	f = 1.0 GHz		29.0	
NF	50 Ω Noise Figure	f = 1.0 GHz		6.5	
t _D	Group Delay	f = 1.0 GHz		190	
V _d	Device Voltage		6.7	8.4	10.1
dV/dT	Device Voltage Temperature Coefficient			-16.0	

Notes:

1. The recommended operating current range for this device is 60 to 100 mA. Typical performance as a function of current is on the following page.
2. Referenced from 0.1 GHz Gain (G_P).

Part Number Ordering Information

Part Number	No. of Devices	Container
MSA-0505-TR1	500	7" Reel
MSA-0505-STR	10	Strip

For more information, see "Tape and Reel Packaging for Semiconductor Devices".

MSA-0505 Typical Scattering Parameters ($T_A = 25^\circ\text{C}$, $I_d = 80\text{ mA}$)

Freq. MHz	S_{11}		S_{21}			S_{12}			S_{22}		k
	Mag	Ang	dB	Mag	Ang	dB	Mag	Ang	Mag	Ang	
5	.56	-39	14.9	5.56	161	-18.5	.120	39	.65	-36	0.60
25	.24	-103	9.7	3.05	156	-13.9	.202	12	.25	-90	0.97
50	.15	-130	8.2	2.57	163	-13.7	.207	7	.15	-116	1.15
100	.13	-155	7.8	2.45	165	-13.7	.207	3	.11	-132	1.21
200	.12	-170	7.7	3.43	161	-13.5	.211	1	.11	-145	1.21
400	.12	178	7.5	2.37	148	-13.6	.209	-1	.14	-146	1.23
600	.13	172	7.4	2.34	134	-13.6	.209	-2	.17	-151	1.23
800	.13	168	7.2	2.29	119	-13.6	.209	-3	.21	-157	1.23
1000	.14	166	7.0	2.24	105	-13.4	.213	-4	.25	-164	1.21
1500	.21	159	6.4	2.09	72	-13.3	.217	-6	.34	176	1.16
2000	.30	148	5.2	1.82	42	-13.1	.222	-9	.42	159	1.12
2500	.40	136	4.1	1.60	17	-12.9	.227	-11	.48	146	1.05
3000	.52	121	2.7	1.36	-7	-12.6	.234	-16	.55	133	0.92

A model for this device is available in the DEVICE MODELS section.

Typical Performance, $T_A = 25^\circ\text{C}$

(unless otherwise noted)

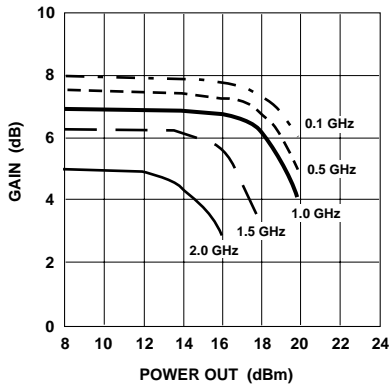

Figure 1. Typical Gain vs. Power Out, $T_A = 25^\circ\text{C}$, $I_d = 80\text{ mA}$.

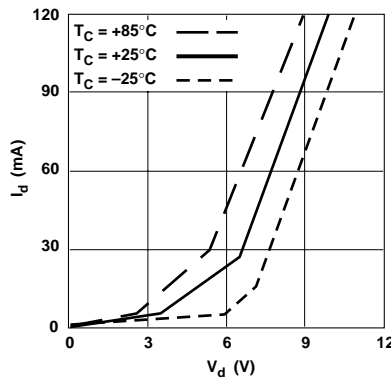

Figure 2. Device Current vs. Voltage.

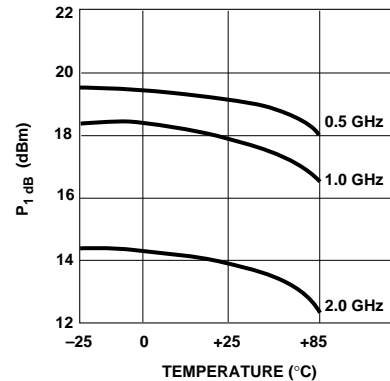

Figure 3. Output Power at 1 dB Gain Compression, vs. Case Temperature, $I_d = 80\text{ mA}$.

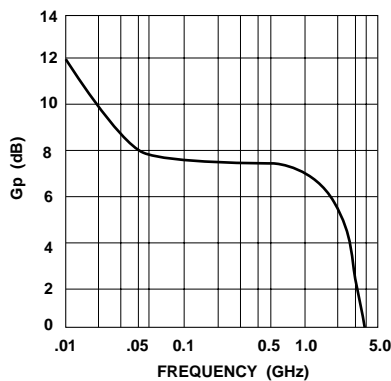

Figure 4. Gain vs. Frequency, $I_d = 80\text{ to }100\text{ mA}$.

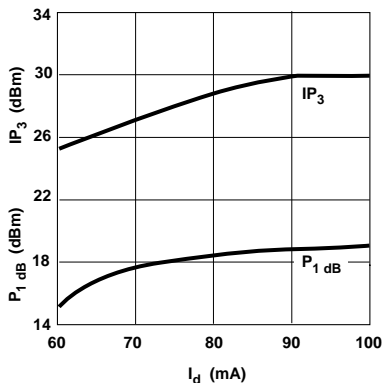
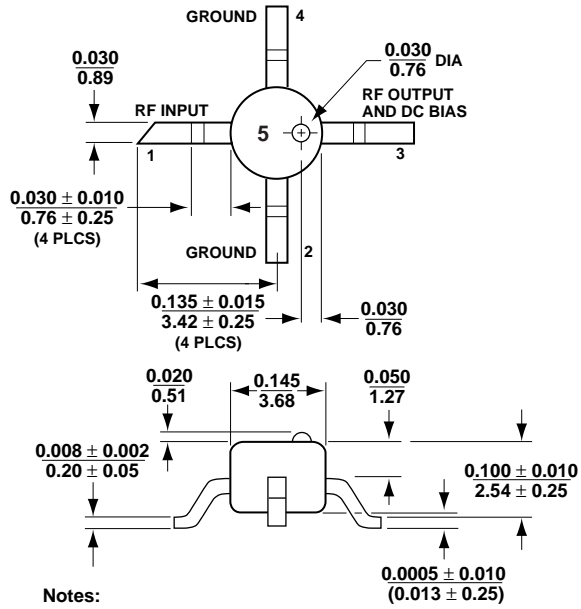

Figure 5. Output Power at 1 dB Gain Compression, Third Order Intercept vs. Case Temperature, $f = 1.0\text{ GHz}$.

05 Plastic Package Dimensions



Notes:

(unless otherwise specified)

1. Dimensions are $\frac{\text{in}}{\text{mm}}$
2. Tolerances
in .xxx = ± 0.005
mm .xx = ± 0.13