

# TrenchMOS™ transistor Logic level FET

**BUK9635-100A**

## GENERAL DESCRIPTION

N-channel enhancement mode logic level field-effect power transistor in a plastic envelope suitable for surface mounting. Using 'trench' technology the device features very low on-state resistance. It is intended for use in automotive and general purpose switching applications.

## QUICK REFERENCE DATA

| SYMBOL       | PARAMETER                        | MAX.                   | UNIT |    |
|--------------|----------------------------------|------------------------|------|----|
| $V_{DS}$     | Drain-source voltage             | 100                    | V    |    |
| $I_D$        | Drain current (DC)               | 40                     | A    |    |
| $P_{tot}$    | Total power dissipation          | 150                    | W    |    |
| $T_j$        | Junction temperature             | 175                    | °C   |    |
| $R_{DS(ON)}$ | Drain-source on-state resistance | $V_{GS} = 5\text{ V}$  | 35   | mΩ |
|              |                                  | $V_{GS} = 10\text{ V}$ | 34   | mΩ |

## PINNING - SOT404

| PIN | DESCRIPTION                       |
|-----|-----------------------------------|
| 1   | gate                              |
| 2   | drain<br>(no connection possible) |
| 3   | source                            |
| mb  | drain                             |

## PIN CONFIGURATION

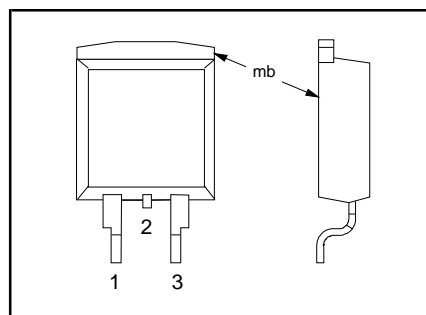

## SYMBOL

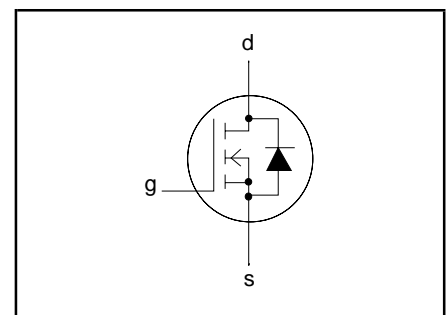

## LIMITING VALUES

Limiting values in accordance with the Absolute Maximum System (IEC 134)

| SYMBOL         | PARAMETER                          | CONDITIONS                           | MIN. | MAX. | UNIT |
|----------------|------------------------------------|--------------------------------------|------|------|------|
| $V_{DS}$       | Drain-source voltage               | -                                    | -    | 100  | V    |
| $V_{DGR}$      | Drain-gate voltage                 | $R_{GS} = 20\text{ k}\Omega$         | -    | 100  | V    |
| $\pm V_{GS}$   | Gate-source voltage                | -                                    | -    | 10   | V    |
| $\pm V_{GSM}$  | Non Repetitive gate-source voltage | -                                    | -    | 15   | V    |
| $I_D$          | Drain current (DC)                 | $T_{mb} = 25\text{ }^\circ\text{C}$  | -    | 40   | A    |
| $I_D$          | Drain current (DC)                 | $T_{mb} = 100\text{ }^\circ\text{C}$ | -    | 29   | A    |
| $I_{DM}$       | Drain current (pulse peak value)   | $T_{mb} = 25\text{ }^\circ\text{C}$  | -    | 133  | A    |
| $P_{tot}$      | Total power dissipation            | $T_{mb} = 25\text{ }^\circ\text{C}$  | -    | 150  | W    |
| $T_{stg}, T_j$ | Storage & operating temperature    | -                                    | -55  | 175  | °C   |

## THERMAL RESISTANCES

| SYMBOL         | PARAMETER                                    | CONDITIONS                   | TYP. | MAX. | UNIT |
|----------------|--|------------------------------|------|------|------|
| $R_{th\ j-mb}$ | Thermal resistance junction to mounting base | -                            | -    | 1.01 | K/W  |
| $R_{th\ j-a}$  | Thermal resistance junction to ambient       | Minimum footprint, FR4 board | 50   | -    | K/W  |

## TrenchMOS™ transistor Logic level FET

BUK9635-100A

### STATIC CHARACTERISTICS

T<sub>j</sub> = 25 °C unless otherwise specified

| SYMBOL               | PARAMETER                        | CONDITIONS  | MIN.      | TYP.     | MAX.   | UNIT   |
|----------------------|----------------------------------|---|-----------|----------|--------|--------|
| V <sub>(BR)DSS</sub> | Drain-source breakdown voltage   | V <sub>GS</sub> = 0 V; I <sub>D</sub> = 0.25 mA;<br>T <sub>j</sub> = -55 °C                                     | 100<br>89 | -<br>-   | -<br>- | V<br>V |
| V <sub>GS(TO)</sub>  | Gate threshold voltage           | V <sub>DS</sub> = V <sub>GS</sub> ; I <sub>D</sub> = 1 mA<br>T <sub>j</sub> = 175 °C<br>T <sub>j</sub> = -55 °C | 1<br>0.5  | 1.5<br>- | 2<br>- | V<br>V |
| I <sub>DSS</sub>     | Zero gate voltage drain current  | V <sub>DS</sub> = 100 V; V <sub>GS</sub> = 0 V;<br>T <sub>j</sub> = 175 °C                                      | -         | 0.05     | 10     | μA     |
| I <sub>GSS</sub>     | Gate source leakage current      | V <sub>GS</sub> = ±10 V; V <sub>DS</sub> = 0 V  | -         | 2        | 100    | nA     |
| R <sub>DS(ON)</sub>  | Drain-source on-state resistance | V <sub>GS</sub> = 5 V; I <sub>D</sub> = 25 A<br>T <sub>j</sub> = 175 °C   | -         | 26       | 35     | mΩ     |
|                      |                                  | V <sub>GS</sub> = 10 V; I <sub>D</sub> = 25 A   | -         | 24.1     | 34     | mΩ     |
|                      |                                  | V <sub>GS</sub> = 4.5 V; I <sub>D</sub> = 25 A  | -         | 26.1     | 38     | mΩ     |

### DYNAMIC CHARACTERISTICS

T<sub>mb</sub> = 25 °C unless otherwise specified

| SYMBOL             | PARAMETER                  | CONDITIONS   | MIN. | TYP. | MAX. | UNIT |
|--------------------|----------------------------|--|------|------|------|------|
| C <sub>iss</sub>   | Input capacitance          | V <sub>GS</sub> = 0 V; V <sub>DS</sub> = 25 V; f = 1 MHz     | -    | 2700 | 3500 | pF   |
| C <sub>oss</sub>   | Output capacitance         |  | -    | 260  | 314  | pF   |
| C <sub>rss</sub>   | Feedback capacitance       |  | -    | 160  | 220  | pF   |
| t <sub>d on</sub>  | Turn-on delay time         | V <sub>DD</sub> = 30 V; R <sub>load</sub> = 1.2 Ω;           | -    | 10   | 15   | ns   |
| t <sub>r</sub>     | Turn-on rise time          | V <sub>GS</sub> = 10 V; R <sub>G</sub> = 10 Ω                | -    | 62   | 87   | ns   |
| t <sub>d off</sub> | Turn-off delay time        |  | -    | 194  | 291  | ns   |
| t <sub>f</sub>     | Turn-off fall time         |  | -    | 108  | 162  | ns   |
| L <sub>d</sub>     | Internal drain inductance  | Measured from upper edge of drain tab to centre of die       | -    | 2.5  | -    | nH   |
| L <sub>s</sub>     | Internal source inductance | Measured from source lead soldering point to source bond pad | -    | 7.5  | -    | nH   |

### REVERSE DIODE LIMITING VALUES AND CHARACTERISTICS

T<sub>j</sub> = 25 °C unless otherwise specified

| SYMBOL           | PARAMETER                        | CONDITIONS  | MIN. | TYP. | MAX. | UNIT |
|------------------|----------------------------------|---|------|------|------|------|
| I <sub>DR</sub>  | Continuous reverse drain current |   | -    | -    | 40   | A    |
| I <sub>DRM</sub> | Pulsed reverse drain current     |   | -    | -    | 133  | A    |
| V <sub>SD</sub>  | Diode forward voltage            | I <sub>F</sub> = 25 A; V <sub>GS</sub> = 0 V            | -    | 0.85 | 1.2  | V    |
|                  |                                  | I <sub>F</sub> = 40 A; V <sub>GS</sub> = 0 V            | -    | 1.1  | -    | V    |
| t <sub>rr</sub>  | Reverse recovery time            | I <sub>F</sub> = 40 A; -di <sub>F</sub> /dt = 100 A/μs; | -    | 60   | -    | ns   |
| Q <sub>rr</sub>  | Reverse recovery charge          | V <sub>GS</sub> = -10 V; V <sub>R</sub> = 30 V          | -    | 0.3  | -    | μC   |

### AVALANCHE LIMITING VALUE

| SYMBOL           | PARAMETER   | CONDITIONS  | MIN. | TYP. | MAX. | UNIT |
|------------------|---|---|------|------|------|------|
| W <sub>DSS</sub> | Drain-source non-repetitive unclamped inductive turn-off energy | I <sub>D</sub> = 40 A; V <sub>DD</sub> ≤ 25 V;<br>V <sub>GS</sub> = 10 V; R <sub>GS</sub> = 50 Ω; T <sub>mb</sub> = 25 °C | -    | -    | 125  | mJ   |

TrenchMOS™ transistor  
Logic level FET

BUK9635-100A

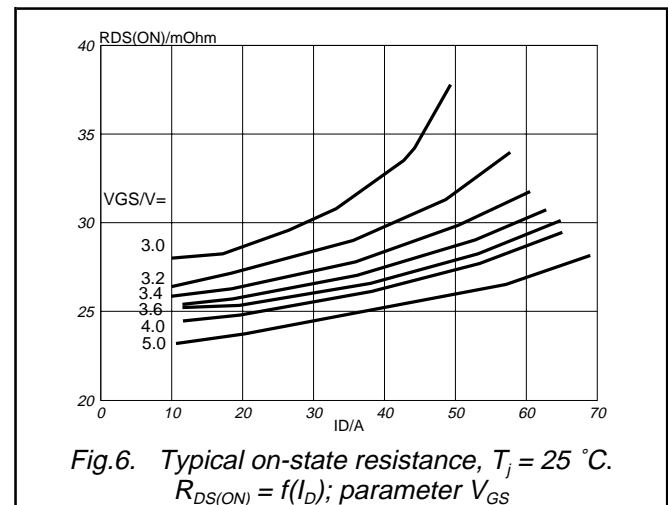
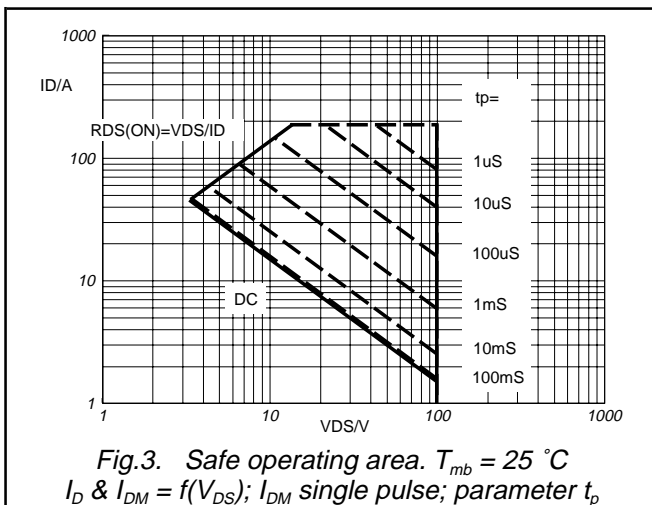
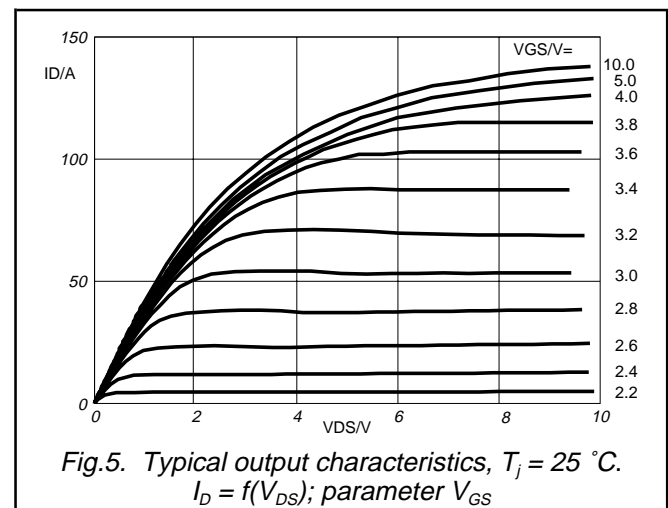
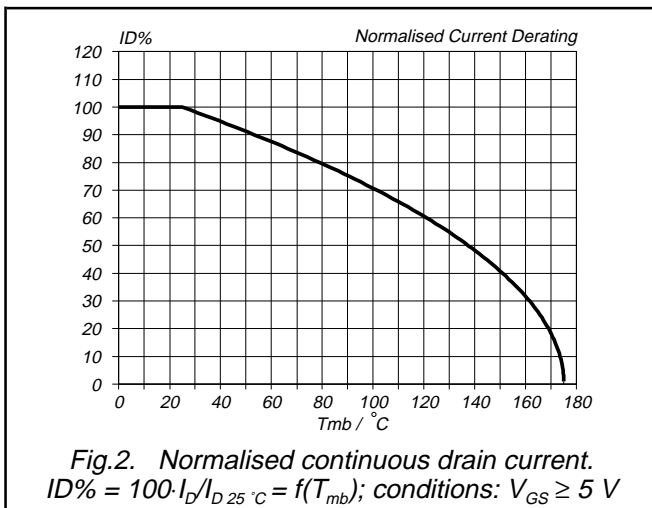
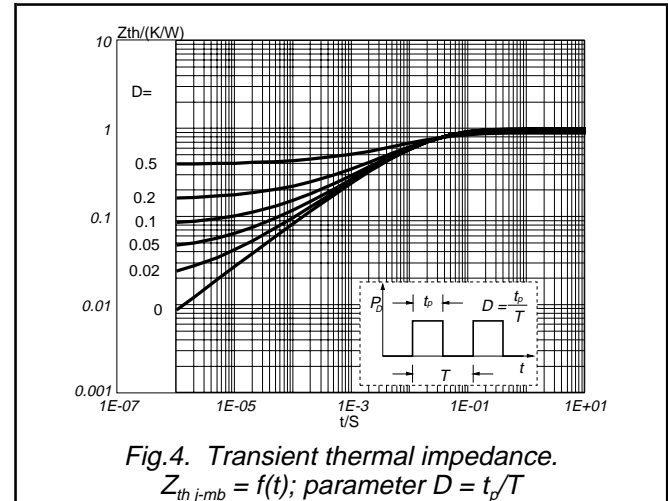
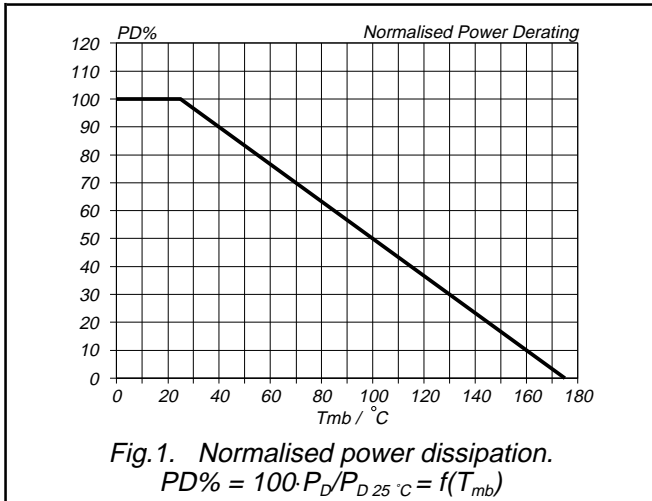

TrenchMOS™ transistor  
Logic level FET

BUK9635-100A

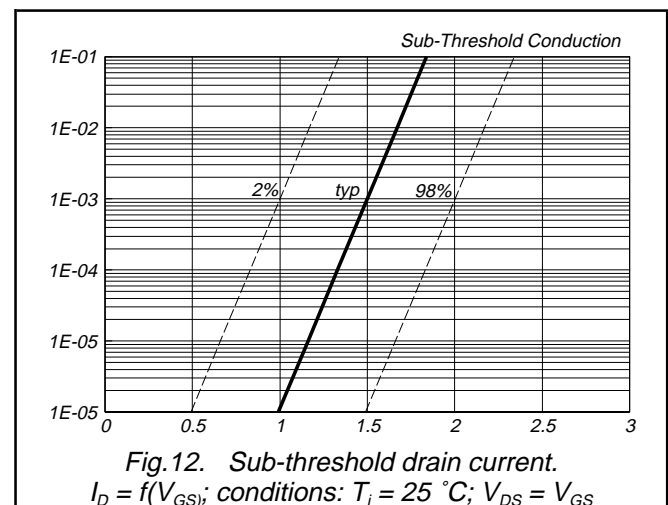
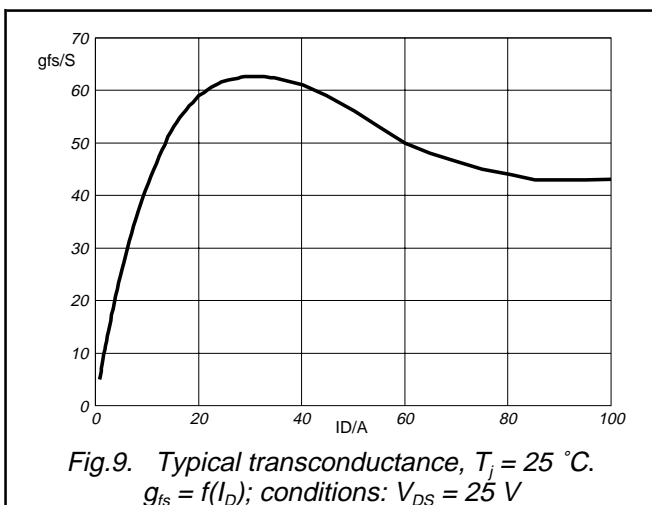
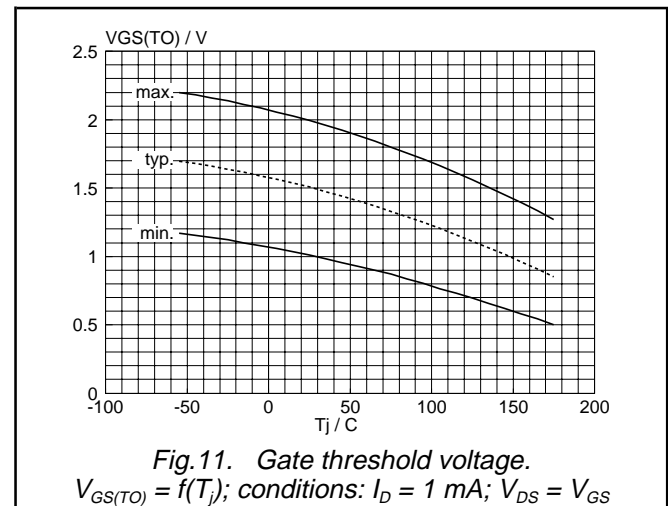
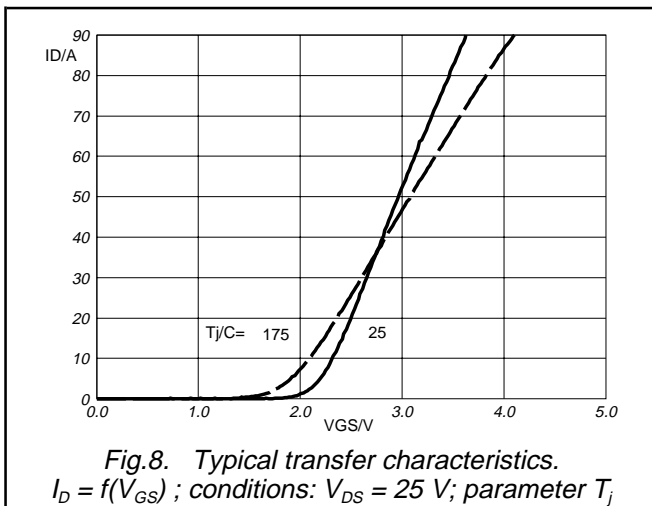
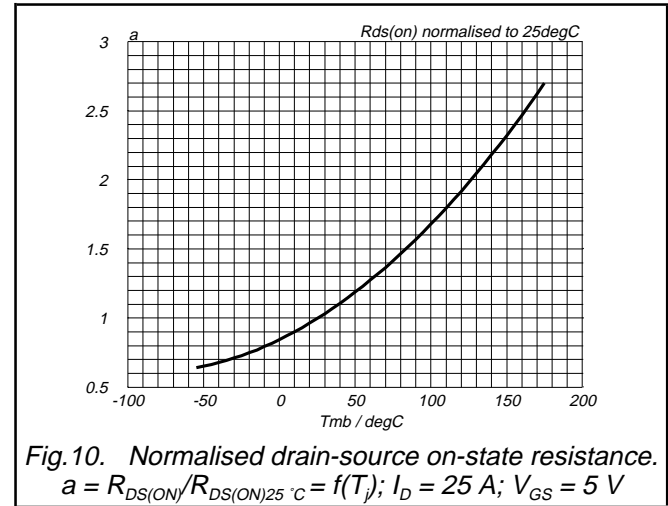
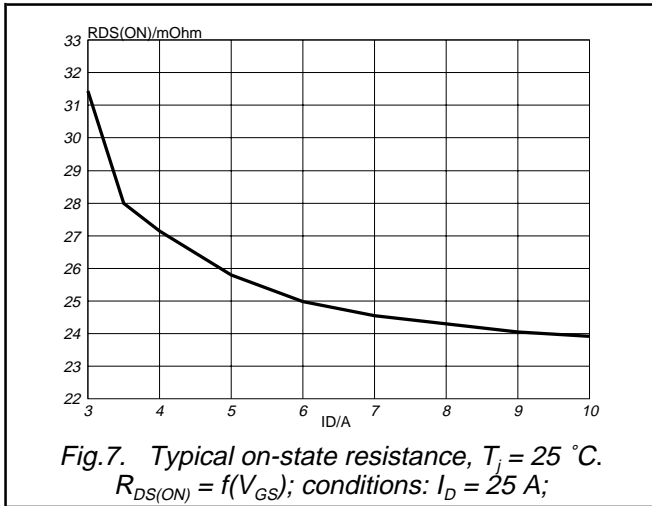

TrenchMOS™ transistor  
Logic level FET

BUK9635-100A

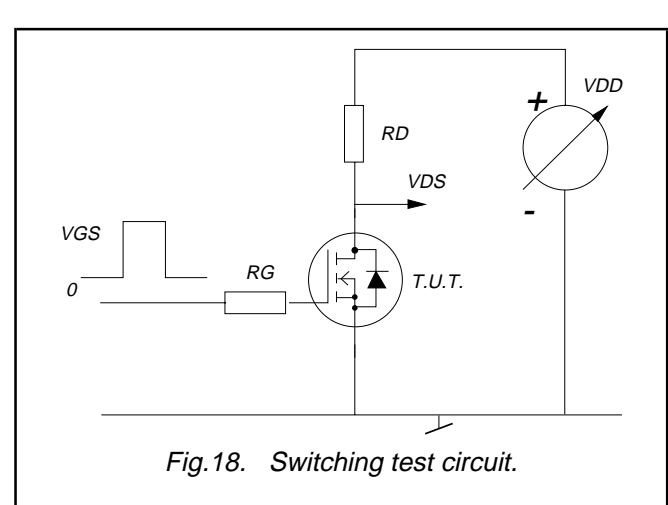
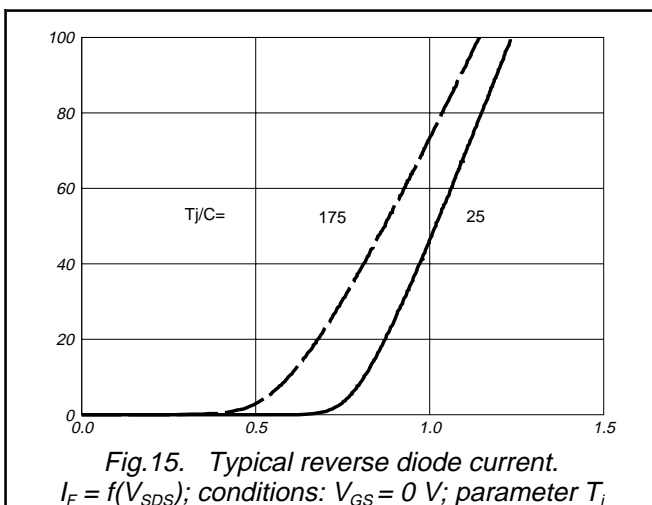
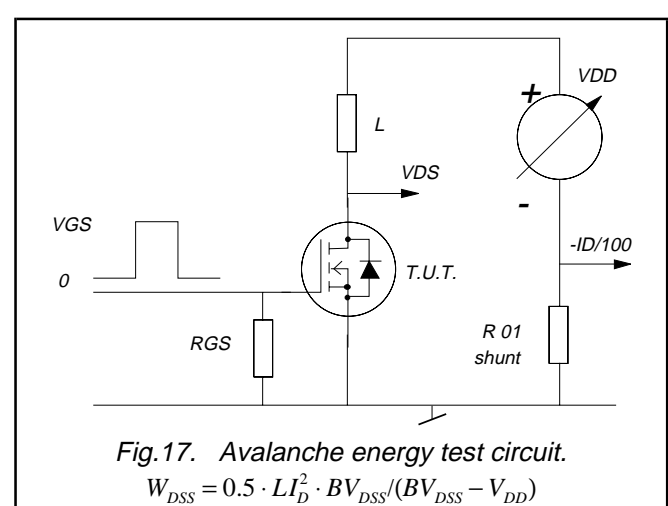
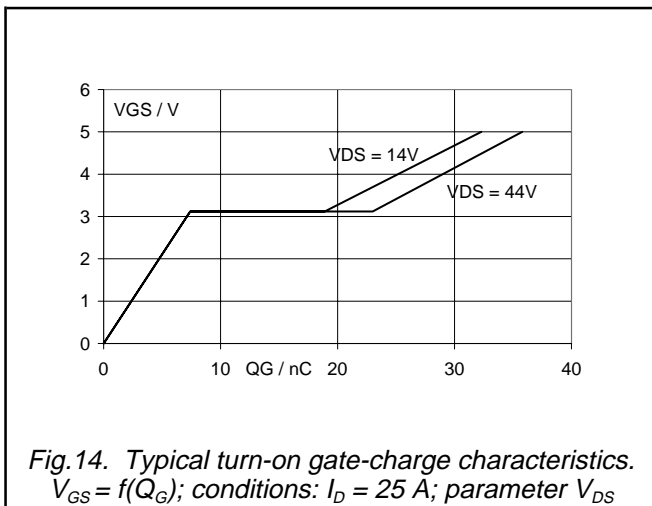
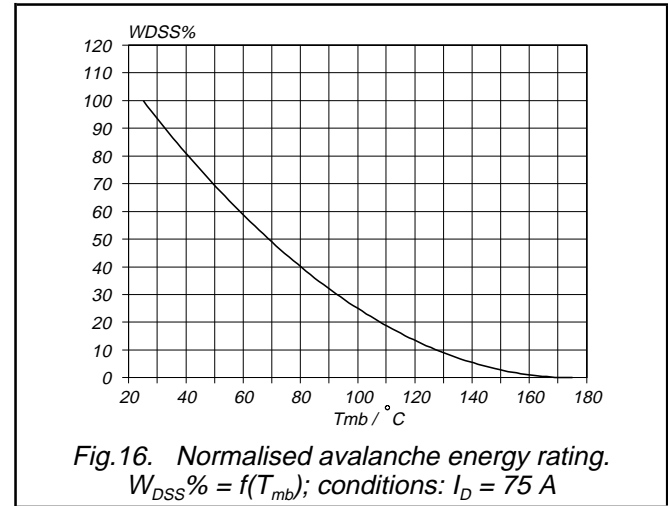
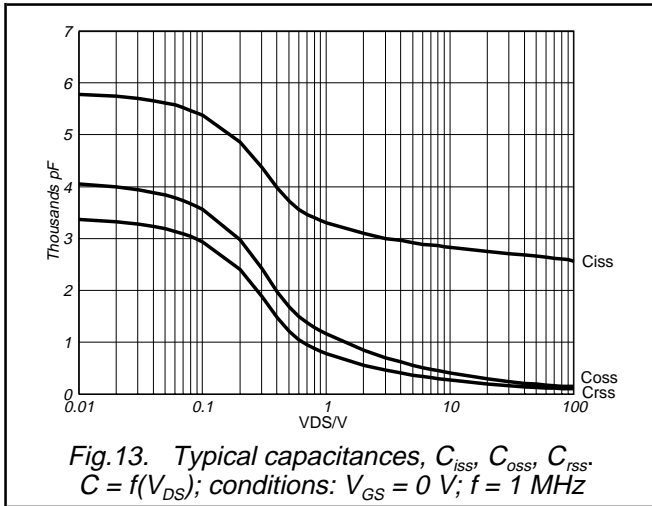

TrenchMOS™ transistor  
Logic level FET

BUK9635-100A

MECHANICAL DATA

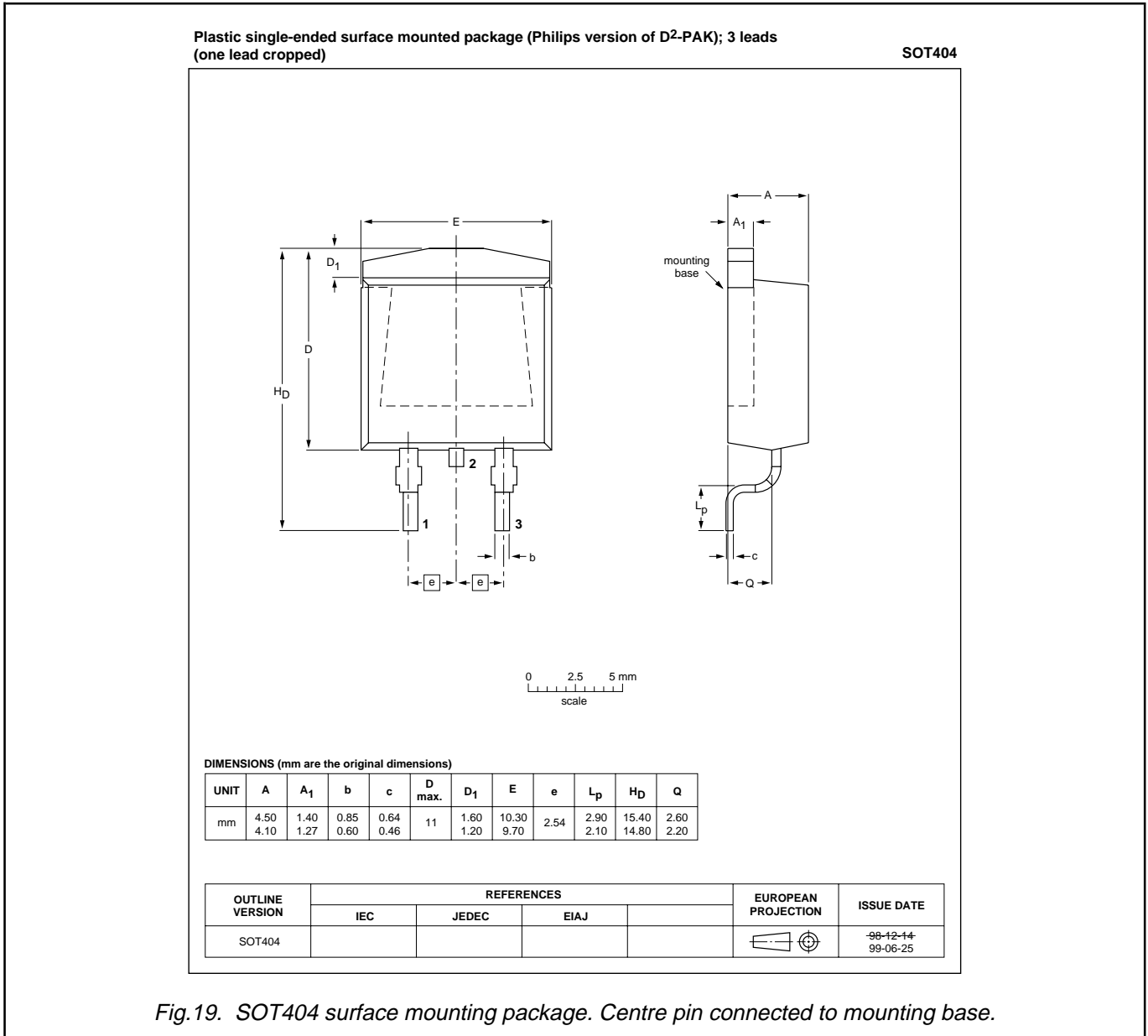

Fig.19. SOT404 surface mounting package. Centre pin connected to mounting base.

Notes

1. This product is supplied in anti-static packaging. The gate-source input must be protected against static discharge during transport or handling.
2. Refer to SMD Footprint Design and Soldering Guidelines, Data Handbook SC18.
3. Epoxy meets UL94 V0 at 1/8".

TrenchMOS™ transistor  
Logic level FET

BUK9635-100A

**MOUNTING INSTRUCTIONS**

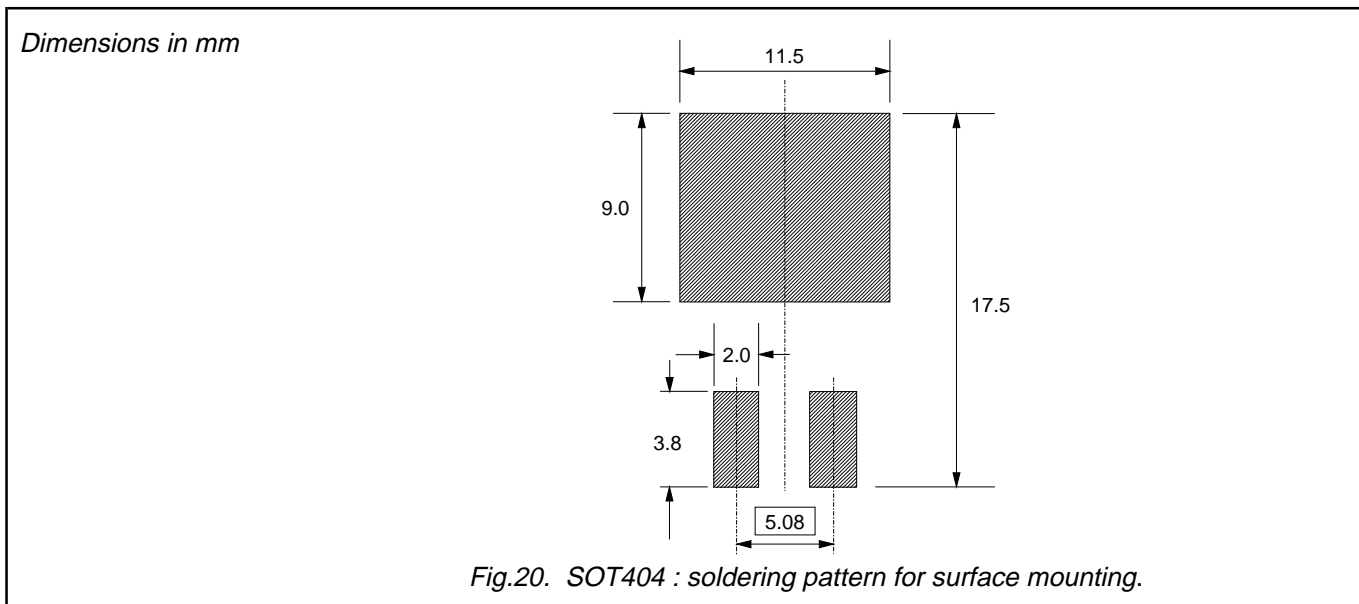

**DEFINITIONS**

|  |   |
|--|---|
| <b>Data sheet status</b>   |   |
| Objective specification  | This data sheet contains target or goal specifications for product development.       |
| Preliminary specification  | This data sheet contains preliminary data; supplementary data may be published later. |
| Product specification  | This data sheet contains final product specifications.                                |
| <b>Limiting values</b>   |   |
| Limiting values are given in accordance with the Absolute Maximum Rating System (IEC 134). Stress above one or more of the limiting values may cause permanent damage to the device. These are stress ratings only and operation of the device at these or at any other conditions above those given in the Characteristics sections of this specification is not implied. Exposure to limiting values for extended periods may affect device reliability. |   |
| <b>Application information</b>   |   |
| Where application information is given, it is advisory and does not form part of the specification.  |   |
| © Philips Electronics N.V. 1999  |   |
| All rights are reserved. Reproduction in whole or in part is prohibited without the prior written consent of the copyright owner.  |   |
| The information presented in this document does not form part of any quotation or contract, it is believed to be accurate and reliable and may be changed without notice. No liability will be accepted by the publisher for any consequence of its use. Publication thereof does not convey nor imply any license under patent or other industrial or intellectual property rights.   |   |

**LIFE SUPPORT APPLICATIONS**

These products are not designed for use in life support appliances, devices or systems where malfunction of these products can be reasonably expected to result in personal injury. Philips customers using or selling these products for use in such applications do so at their own risk and agree to fully indemnify Philips for any damages resulting from such improper use or sale.