

NPN Silicon Switching Transistor

- High DC current gain: 0.1mA to 100mA
- Low collector-emitter saturation voltage
- Complementary type: SMBT3906 (PNP)

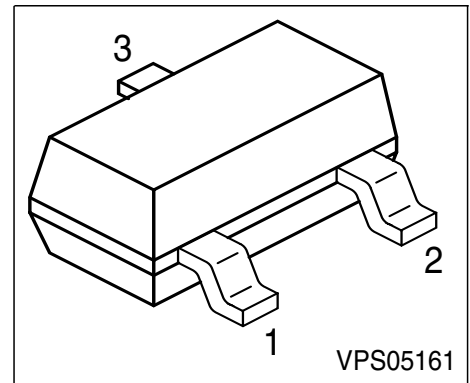

Type	Marking	Pin Configuration			Package
SMBT3904/ MMBT3904	s1A	1 = B	2 = E	3 = C	SOT23

Maximum Ratings

Parameter	Symbol	Value	Unit
Collector-emitter voltage	V_{CEO}	40	V
Collector-base voltage	V_{CBO}	60	
Emitter-base voltage	V_{EBO}	6	
DC collector current	I_C	200	mA
Total power dissipation, $T_S = 69\text{ }^\circ\text{C}$	P_{tot}	330	mW
Junction temperature	T_j	150	$^\circ\text{C}$
Storage temperature	T_{stg}	-65 ... 150	

Thermal Resistance

Junction - soldering point ¹⁾	R_{thJS}	≤ 245	K/W
------------------------------------------	------------	------------	-----

¹⁾For calculation of R_{thJA} please refer to Application Note Thermal Resistance

Electrical Characteristics at $T_A = 25^\circ\text{C}$, unless otherwise specified.

Parameter	Symbol	Values			Unit
		min.	typ.	max.	
DC Characteristics					
Collector-emitter breakdown voltage $I_C = 1 \text{ mA}, I_B = 0$	$V_{(BR)CEO}$	40	-	-	V
Collector-base breakdown voltage $I_C = 10 \mu\text{A}, I_E = 0$	$V_{(BR)CBO}$	60	-	-	
Emitter-base breakdown voltage $I_E = 10 \mu\text{A}, I_C = 0$	$V_{(BR)EBO}$	6	-	-	
Collector cutoff current $V_{CB} = 30 \text{ V}, I_E = 0$	I_{CBO}	-	-	50	nA
DC current gain 1) $I_C = 100 \mu\text{A}, V_{CE} = 1 \text{ V}$ $I_C = 1 \text{ mA}, V_{CE} = 1 \text{ V}$ $I_C = 10 \text{ mA}, V_{CE} = 1 \text{ V}$ $I_C = 50 \text{ mA}, V_{CE} = 1 \text{ V}$ $I_C = 100 \text{ mA}, V_{CE} = 1 \text{ V}$	h_{FE}	40 70 100 60 30	- - - - -	- - 300 - -	-
Collector-emitter saturation voltage1) $I_C = 10 \text{ mA}, I_B = 1 \text{ mA}$ $I_C = 50 \text{ mA}, I_B = 5 \text{ mA}$	V_{CEsat}	- -	- -	0.2 0.3	V
Base-emitter saturation voltage 1) $I_C = 10 \text{ mA}, I_B = 1 \text{ mA}$ $I_C = 50 \text{ mA}, I_B = 5 \text{ mA}$	V_{BEsat}	0.65 -	- -	0.85 0.95	

1) Pulse test: $t \leq 300 \mu\text{s}$, $D = 2\%$

Electrical Characteristics at $T_A = 25^\circ\text{C}$, unless otherwise specified.

Parameter	Symbol	Values			Unit
		min.	typ.	max.	
AC Characteristics					
Transition frequency $I_C = 10\text{ mA}, V_{CE} = 20\text{ V}, f = 100\text{ MHz}$	f_T	300	-	-	MHz
Collector-base capacitance $V_{CB} = 5\text{ V}, f = 1\text{ MHz}$	C_{cb}	-	-	4	pF
Emitter-base capacitance $V_{EB} = 0.5\text{ V}, f = 1\text{ MHz}$	C_{eb}	-	-	8	
Noise figure $I_C = 100\text{ }\mu\text{A}, V_{CE} = 5\text{ V}, R_S = 1\text{ k}\Omega,$ $f = 1\text{ kHz}, \Delta f = 200\text{ Hz}$	F	-	-	5	dB
Short-circuit input impedance $I_C = 1\text{ mA}, V_{CE} = 10\text{ V}, f = 1\text{ kHz}$	h_{11e}	1	-	10	k Ω
Open-circuit reverse voltage transf.ratio $I_C = 1\text{ mA}, V_{CE} = 10\text{ V}, f = 1\text{ kHz}$	h_{12e}	0.5	-	8	10^{-4}
Short-circuit forward current transf.ratio $I_C = 1\text{ mA}, V_{CE} = 10\text{ V}, f = 1\text{ kHz}$	h_{21e}	100	400	-	-
Open-circuit output admittance $I_C = 1\text{ mA}, V_{CE} = 10\text{ V}, f = 1\text{ kHz}$	h_{22e}	1	-	40	μS
Delay time $V_{CC} = 3\text{ V}, I_C = 10\text{ mA}, I_{B1} = 1\text{ mA},$ $V_{BE(\text{off})} = 0.5\text{ V}$	t_d	-	-	35	ns
Rise time $V_{CC} = 3\text{ V}, I_C = 10\text{ mA}, I_{B1} = 1\text{ mA},$ $V_{BE(\text{off})} = 0.5\text{ V}$	t_r	-	-	35	
Storage time $V_{CC} = 3\text{ V}, I_C = 10\text{ mA}, I_{B1}=I_{B2} = 1\text{ mA}$	t_{stg}	-	-	200	
Fall time $V_{CC} = 3\text{ V}, I_C = 10\text{ mA}, I_{B1}=I_{B2} = 1\text{ mA}$	t_f	-	-	50	

Test circuits

Delay and rise time

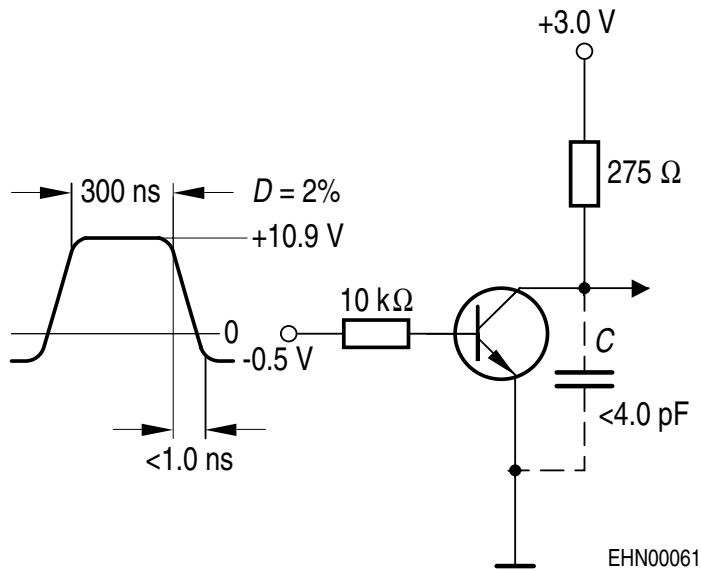

Storage and fall time

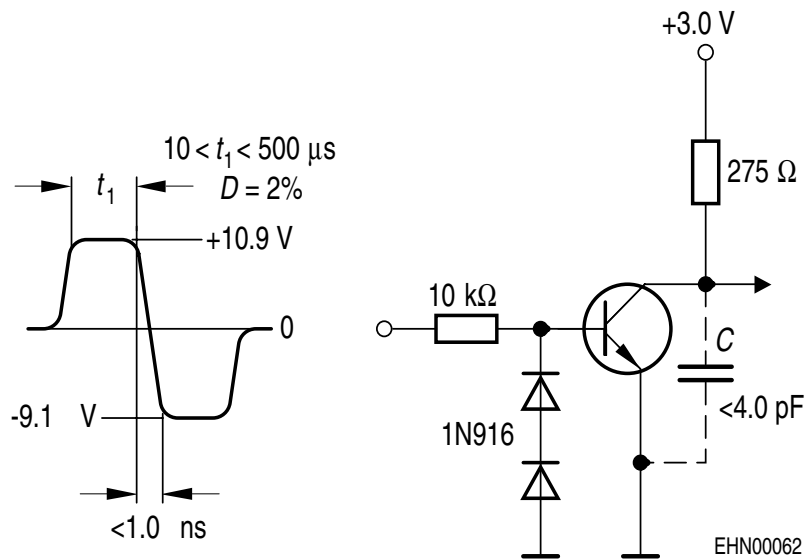

Total power dissipation $P_{tot} = f(T_S)$

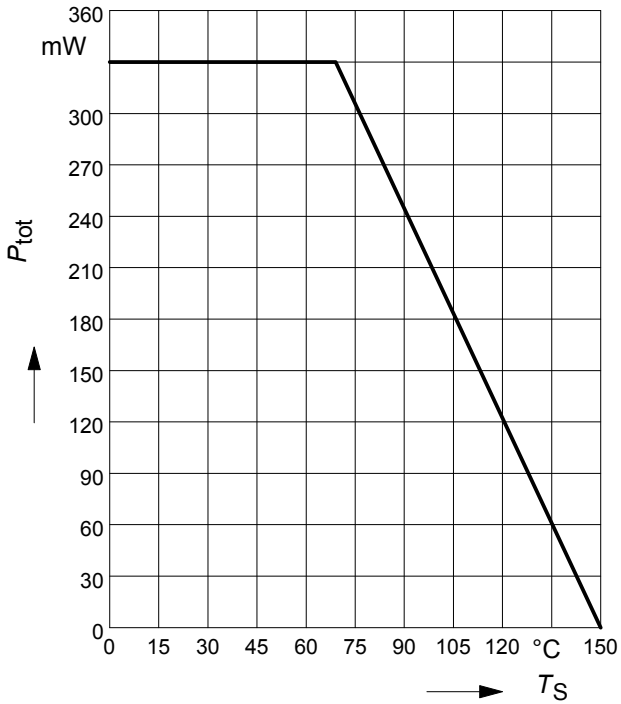

**Saturation voltage $I_C = f(V_{BEsat}, V_{CEsat})$
 $h_{FE} = 10$**

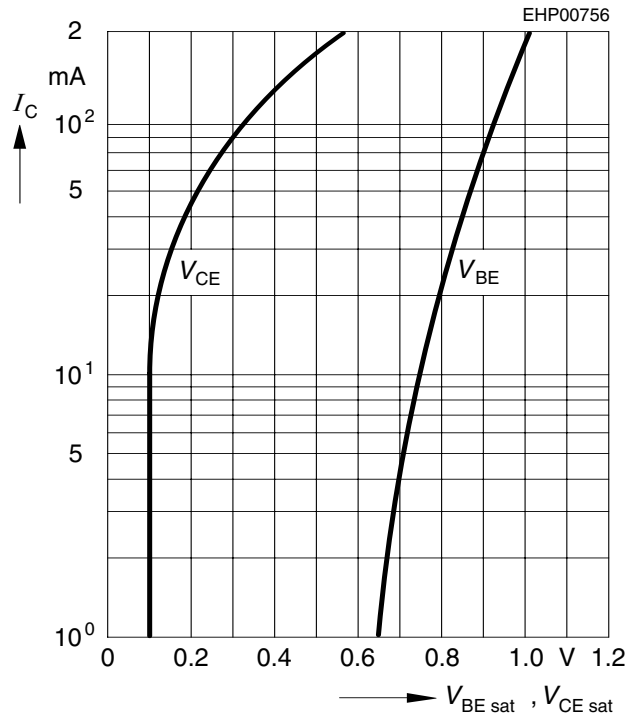

Permissible pulse load

$P_{totmax} / P_{totDC} = f(t_p)$

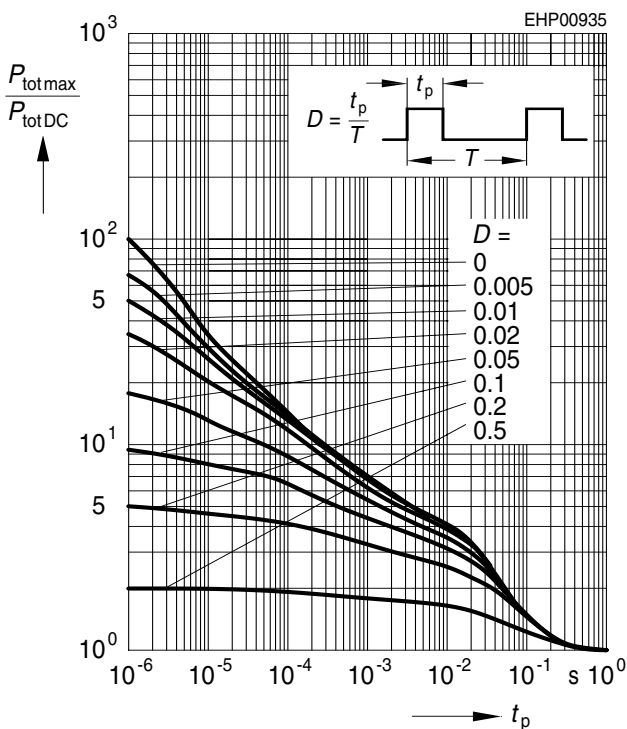

DC current gain $h_{FE} = f(I_C)$

$V_{CE} = 10V$, normalized

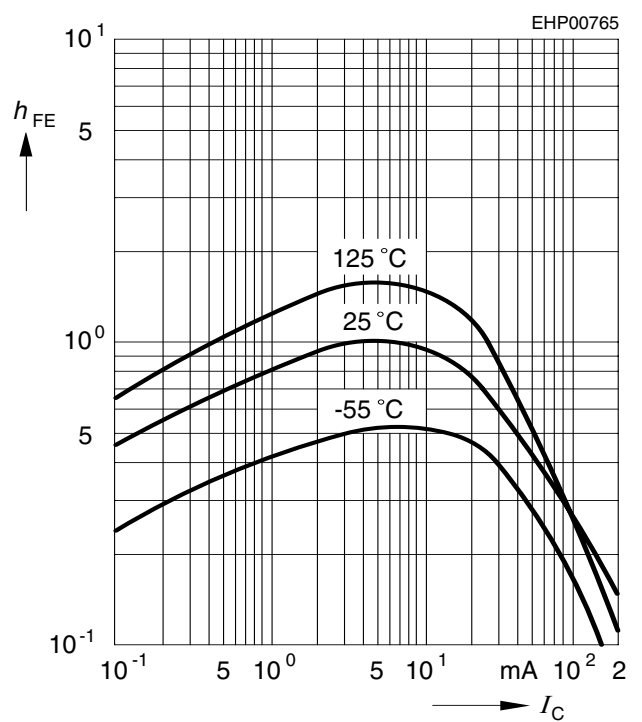

Short-circuit forward current

transfer ratio $h_{21e} = f(I_C)$

$V_{CE} = 10V, f = 1MHz$

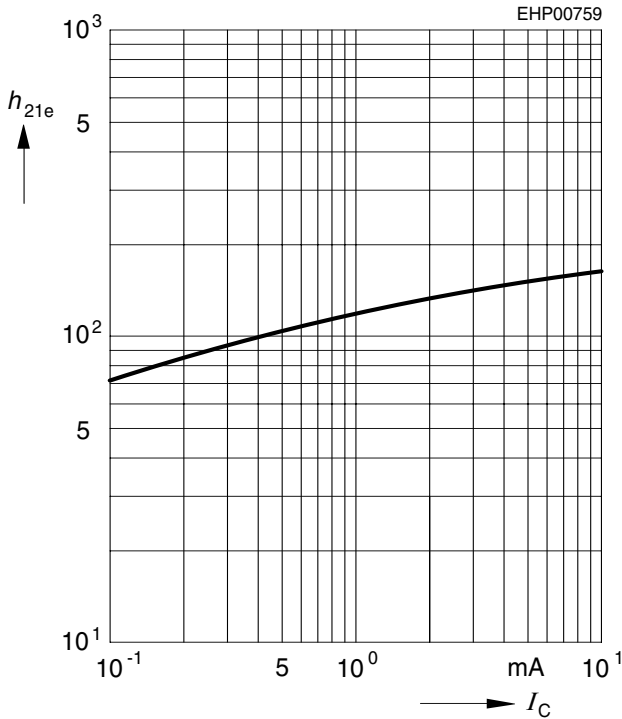

Open-circuit output admittance

$h_{22e} = f(I_C)$

$V_{CE} = 10V, f = 1MHz$

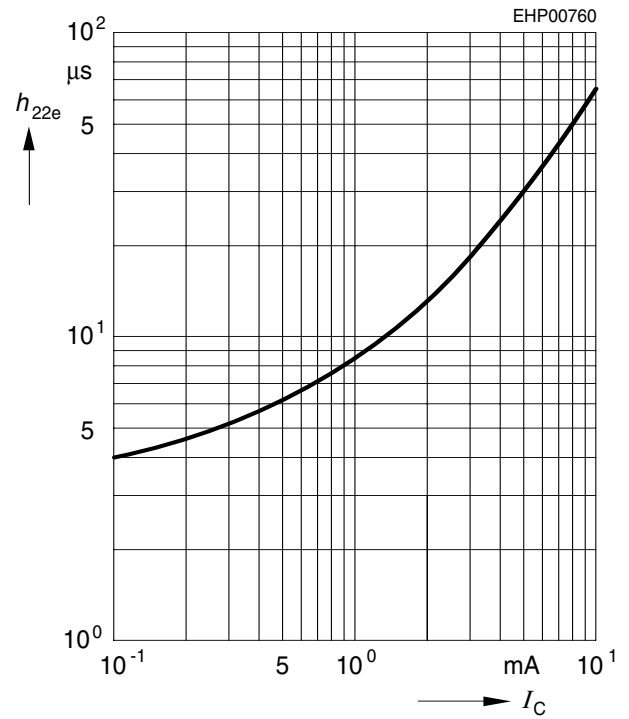

Delay time $t_d = f(I_C)$

Rise time $t_r = f(I_C)$

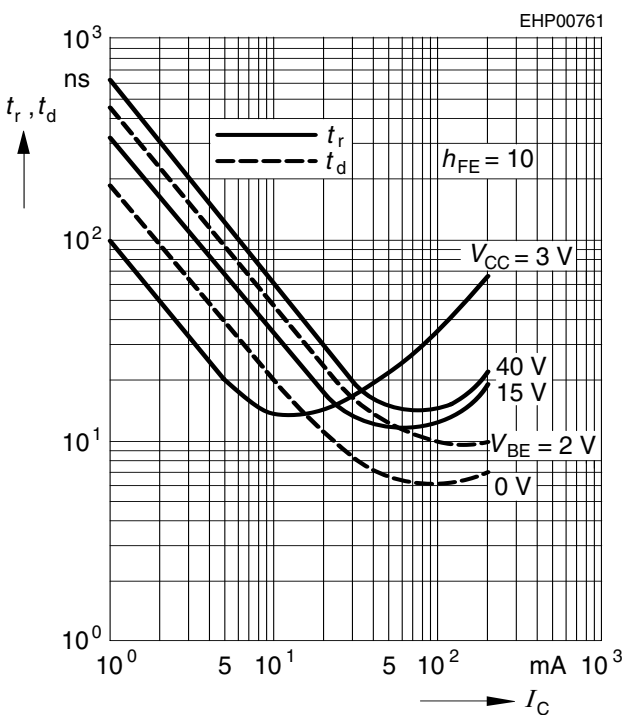

Storage time $t_{stg} = f(I_C)$

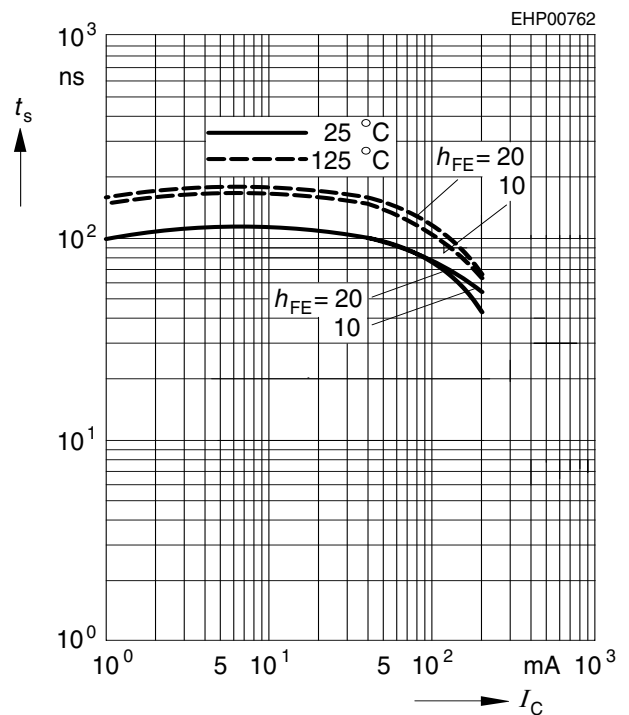

Fall time $t_f = f(I_C)$

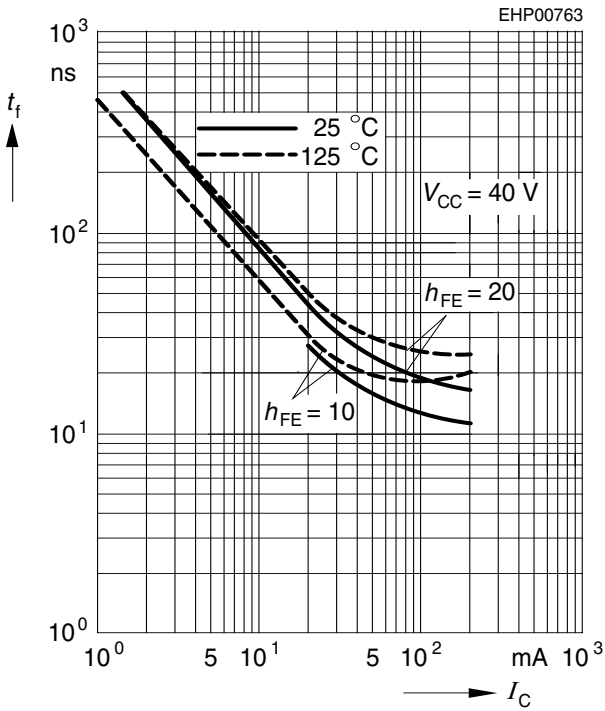

Rise time $t_r = f(I_C)$

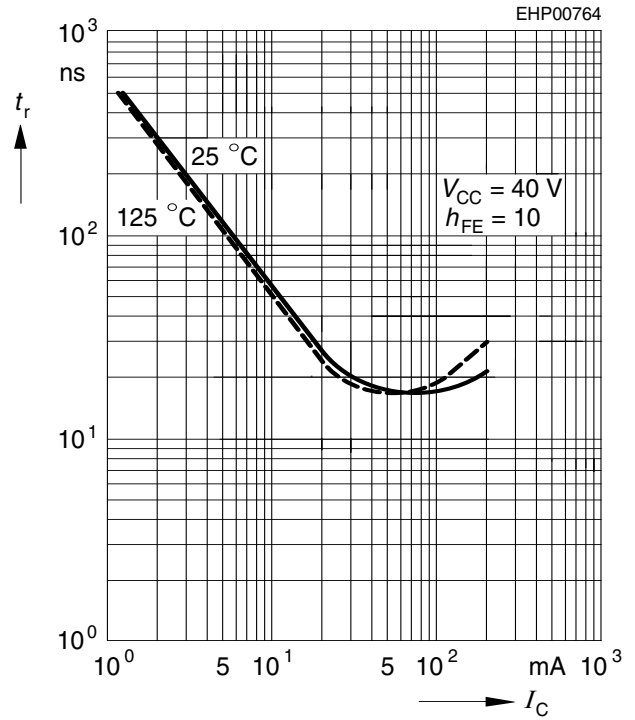

Input impedance

$h_{11e} = f(I_C)$
 $V_{CE} = 10V, f = 1kHz$

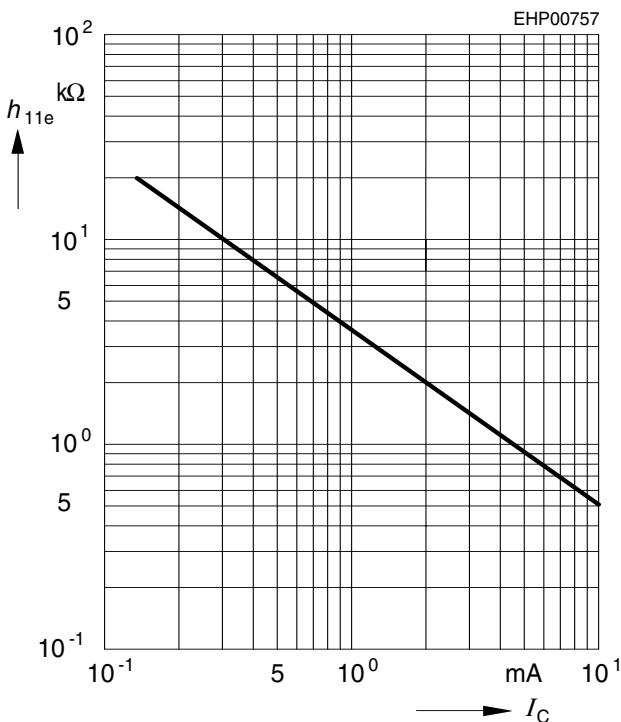

Open-circuit reverse voltage

transfer ratio $h_{12e} = f(I_C)$
 $V_{CE} = 10V, f = 1kHz$

