



# STS7C4F30L

N-CHANNEL 30V - 0.018  $\Omega$  - 7A SO-8

P-CHANNEL 30V - 0.070  $\Omega$  - 4A SO-8

STripFET™ POWER MOSFET

TYPE	V <sub>DSS</sub>	R <sub>DS(on)</sub>	I <sub>D</sub>
STS7C4F30L(N-Channel)	30 V	<0.022 $\Omega$	7 A
STS7C4F30L(P-Channel)	30 V	<0.080 $\Omega$	4 A

- TYPICAL R<sub>DS(on)</sub> (N-Channel) = 0.018  $\Omega$
- TYPICAL R<sub>DS(on)</sub> (P-Channel) = 0.070  $\Omega$
- STANDARD OUTLINE FOR EASY AUTOMATED SURFACE MOUNT ASSEMBLY
- LOW THRESHOLD DRIVE

## DESCRIPTION

This Power MOSFET is the latest development of STMicroelectronics unique "Single Feature Size™" strip-based process. The resulting transistor shows extremely high packing density for low on-resistance, rugged avalanche characteristics and less critical alignment steps therefore a remarkable manufacturing reproducibility.

## APPLICATIONS

- DC/DC CONVERTERS
- BATTERY MANAGEMENT IN NOMADIC EQUIPMENT
- POWER MANAGEMENT IN CELLULAR PHONES

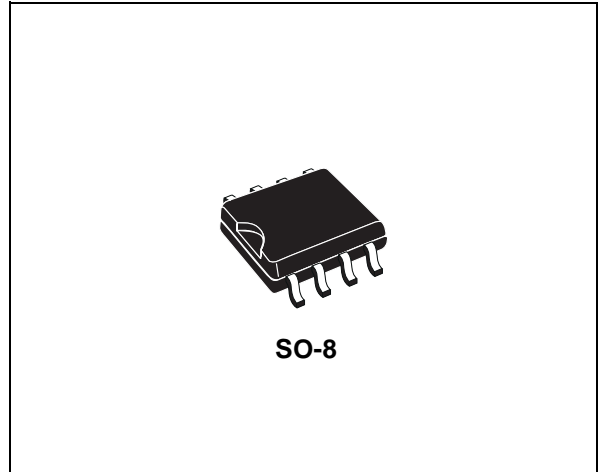

## INTERNAL SCHEMATIC DIAGRAM

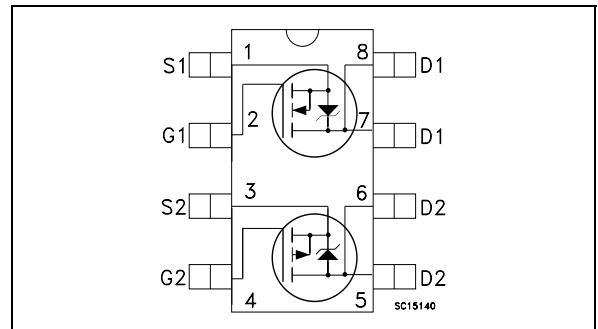

## ABSOLUTE MAXIMUM RATINGS

Symbol	Parameter	N-CHANNEL	P-CHANNEL	Unit
V <sub>DS</sub>	Drain-source Voltage (V <sub>GS</sub> = 0)	30	30	V
V <sub>DGR</sub>	Drain-gate Voltage (R <sub>GS</sub> = 20 k $\Omega$ )	30	30	V
V <sub>GS</sub>	Gate- source Voltage	$\pm 20$	$\pm 20$	V
I <sub>D</sub>	Drain Current (continuous) at T <sub>C</sub> = 25°C Single Operating	7	4	A
I <sub>D</sub>	Drain Current (continuous) at T <sub>C</sub> = 100°C Single Operating	4.4	2.5	A
I <sub>DM</sub> (*)	Drain Current (pulsed)	28	16	A
P <sub>tot</sub>	Total Dissipation at T <sub>C</sub> = 25°C Dual Operating	1.6		W
	Total Dissipation at T <sub>C</sub> = 25°C Single Operating	2		W
T <sub>stg</sub>	Storage Temperature	-60 to 150		°C
T <sub>j</sub>	Max. Operating Junction Temperature	150		°C

(\*) Pulse width limited by safe operating area.

Note: P-CHANNEL MOSFET actual polarity of voltages and current has to be reversed

# STS7C4F30L

## THERMAL DATA

Rthj-amb(1)	Thermal Resistance Junction-ambient	Single Operation	62.5	°C/W
		Dual Operating	78	°C/W
T <sub>l</sub>	Maximum Lead Temperature For Soldering Purpose		300	°C

(1) when mounted on 0.5 in<sup>2</sup> pad of 2 oz. copper

## ELECTRICAL CHARACTERISTICS (T<sub>case</sub> = 25 °C unless otherwise specified)

### OFF

Symbol	Parameter	Test Conditions		Min.	Typ.	Max.	Unit
V <sub>(BR)DSS</sub>	Drain-source Breakdown Voltage	I <sub>D</sub> = 250 μA, V <sub>GS</sub> = 0	n-ch p-ch	30 30			V
I <sub>DSS</sub>	Zero Gate Voltage Drain Current (V <sub>GS</sub> = 0)	V <sub>DS</sub> = Max Rating V <sub>DS</sub> = Max Rating T <sub>C</sub> = 125°C				1 10	μA μA
I <sub>GSS</sub>	Gate-body Leakage Current (V <sub>DS</sub> = 0)	V <sub>GS</sub> = ± 20V V <sub>GS</sub> = ± 20V	n-ch p-ch			±100 ±100	nA nA

### ON

Symbol	Parameter	Test Conditions		Min.	Typ.	Max.	Unit
V <sub>GS(th)</sub>	Gate Threshold Voltage	V <sub>DS</sub> = V <sub>GS</sub> I <sub>D</sub> = 250 μA	n-ch p-ch	1 1	1.6 1.6	2.5 2.5	V V
R <sub>DS(on)</sub>	Static Drain-source On Resistance	V <sub>GS</sub> = 10 V I <sub>D</sub> = 3.5 A V <sub>GS</sub> = 10 V I <sub>D</sub> = 2 A V <sub>GS</sub> = 4.5 V I <sub>D</sub> = 3.5 A V <sub>GS</sub> = 4.5 V I <sub>D</sub> = 2 A	n-ch p-ch n-ch p-ch		0.018 0.070 0.021 0.085	0.022 0.080 0.026 0.10	Ω Ω Ω Ω

### DYNAMIC

Symbol	Parameter	Test Conditions		Min.	Typ.	Max.	Unit
g <sub>fs</sub> (*)	Forward Transconductance	V <sub>DS</sub> = 15 V I <sub>D</sub> = 3.5 A V <sub>DS</sub> = 15 V I <sub>D</sub> = 2 A	n-ch p-ch		10 10		S S
C <sub>iss</sub>	Input Capacitance		n-ch p-ch		1050 1350		pF pF
C <sub>oss</sub>	Output Capacitance	V <sub>DS</sub> = 25V, f = 1 MHz, V <sub>GS</sub> = 0	n-ch p-ch		250 490		pF pF
C <sub>rss</sub>	Reverse Transfer Capacitance		n-ch p-ch		85 130		pF pF

**ELECTRICAL CHARACTERISTICS** (continued)

SWITCHING ON

Symbol	Parameter	Test Conditions		Min.	Typ.	Max.	Unit
$t_{d(on)}$	Turn-on Delay Time	<b>N-CHANNEL</b> $V_{DD} = 15\text{ V}$ $I_D = 3.5\text{ A}$ $R_G = 4.7\ \Omega$ $V_{GS} = 4.5\text{ V}$	n-ch		22		ns
			p-ch		25		ns
$t_r$	Rise Time	<b>P-CHANNEL</b> $V_{DD} = 15\text{ V}$ $I_D = 2\text{ A}$ $R_G = 4.7\ \Omega$ $V_{GS} = 4.5\text{ V}$ (Resistive Load, Figure 1)	n-ch		60		ns
			p-ch		35		ns
$Q_g$	Total Gate Charge	<b>N-CHANNEL</b> $V_{DD} = 24\text{ V}$ $I_D = 7\text{ A}$ $V_{GS} = 5\text{ V}$	n-ch		17.5	23	nC
			p-ch		12.5	16	nC
$Q_{gs}$	Gate-Source Charge	<b>P-CHANNEL</b> $V_{DD} = 24\text{ V}$ $I_D = 4\text{ A}$ $V_{GS} = 5\text{ V}$ (see test circuit, Figure 2)	n-ch		4		nC
			p-ch		5		nC
$Q_{gd}$	Gate-Drain Charge		n-ch		7		nC
			p-ch		3		nC

SWITCHING OFF

Symbol	Parameter	Test Conditions		Min.	Typ.	Max.	Unit
$t_{d(off)}$	Turn-off Delay Time	<b>N-CHANNEL</b> $V_{DD} = 15\text{ V}$ $I_D = 3.5\text{ A}$ $R_G = 4.7\ \Omega$ $V_{GS} = 4.5\text{ V}$	n-ch		42		ns
			p-ch		125		ns
$t_f$	Fall Time	<b>P-CHANNEL</b> $V_{DD} = 15\text{ V}$ $I_D = 2\text{ A}$ $R_G = 4.7\ \Omega$ $V_{GS} = 4.5\text{ V}$ (Resistive Load, Figure 1)	n-ch		10		ns
			p-ch		35		ns

SOURCE DRAIN DIODE

Symbol	Parameter	Test Conditions		Min.	Typ.	Max.	Unit
$I_{SD}$	Source-drain Current		n-ch			7	A
$I_{SDM}(\bullet)$	Source-drain Current (pulsed)		p-ch			4	A
			n-ch			28	A
			p-ch			16	A
$V_{SD}(\ast)$	Forward On Voltage	$I_{SD} = 7\text{ A}$ $V_{GS} = 0$ $I_{SD} = 4\text{ A}$ $V_{GS} = 0$	n-ch			1.2	V
			p-ch			1.2	V
$t_{rr}$	Reverse Recovery Time	<b>N-CHANNEL</b> $I_{SD} = 7\text{ A}$ $di/dt = 100\text{ A}/\mu\text{s}$ $V_{DD} = 15\text{ V}$ $T_j = 150\text{ }^\circ\text{C}$	n-ch		50		ns
			p-ch		45		ns
$Q_{rr}$	Reverse Recovery Charge	<b>P-CHANNEL</b> $I_{SD} = 4\text{ A}$ $di/dt = 100\text{ A}/\mu\text{s}$ $V_{DD} = 15\text{ V}$ $T_j = 150\text{ }^\circ\text{C}$ (see test circuit, Figure 3)	n-ch		40		nC
$I_{RRM}$	Reverse Recovery Current		p-ch		36		nC
			n-ch		1.6		A
			p-ch		1.6		A

(\*) Pulsed: Pulse duration = 300  $\mu\text{s}$ , duty cycle 1.5 %.  
 (•) Pulse width limited by safe operating area.

# STS7C4F30L

## Safe Operating Area n-ch

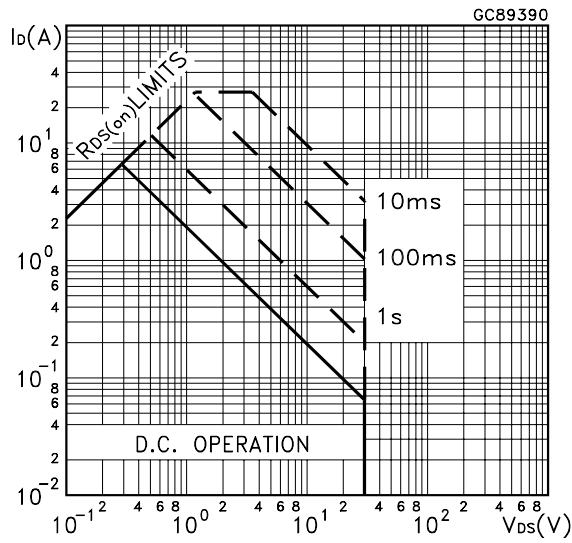

## Thermal Impedance n-ch

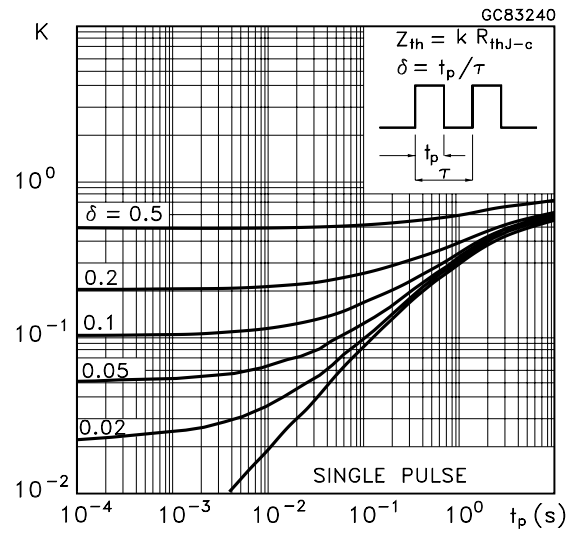

## Output Characteristics n-ch

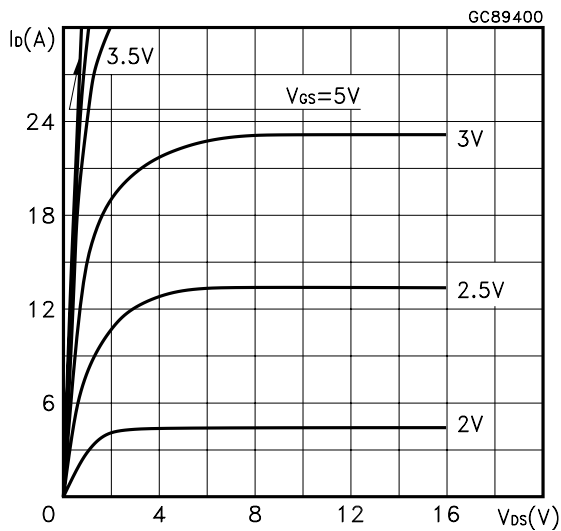

## Transfer Characteristics n-ch

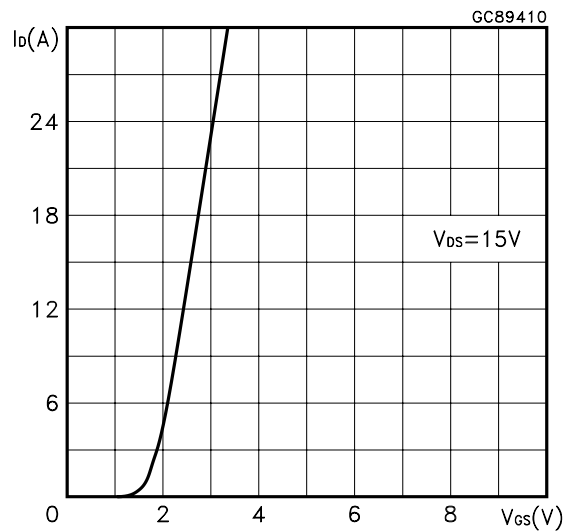

## Transconductance n-ch

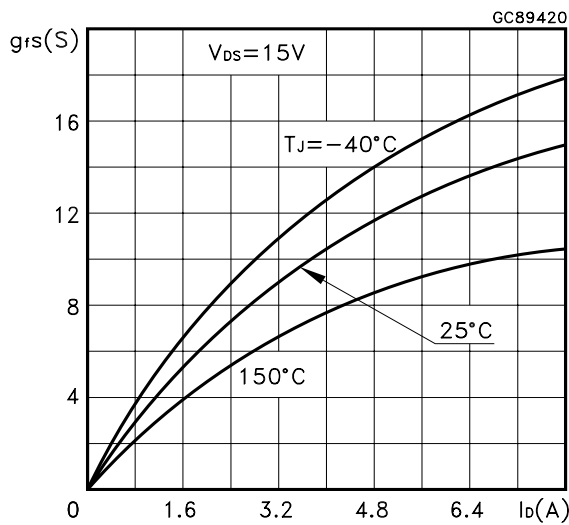

## Static Drain-source On Resistance n-ch

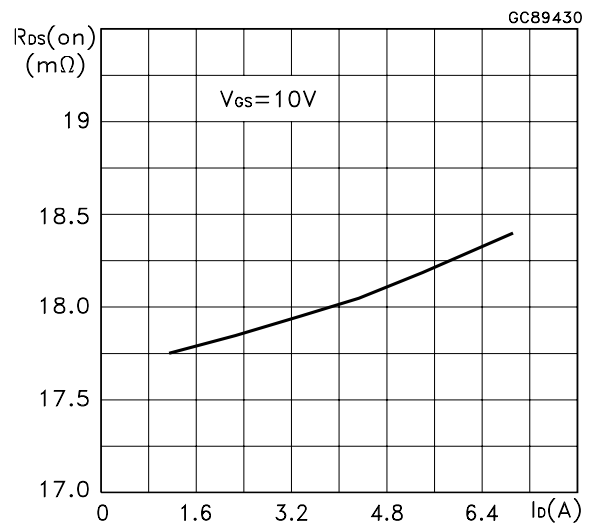

Gate Charge vs Gate-source Voltage **n-ch**

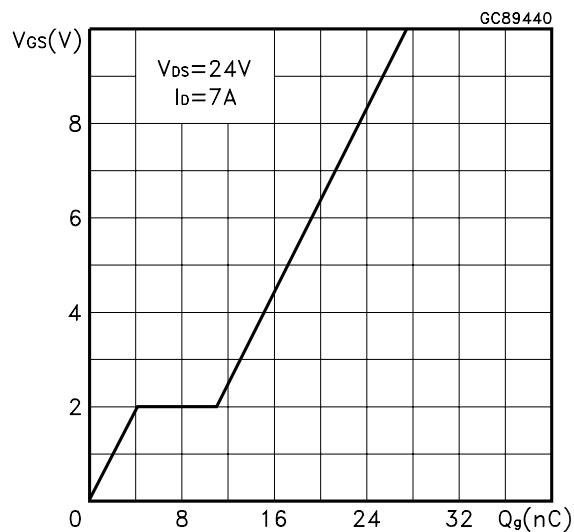

Capacitance Variations **n-ch**

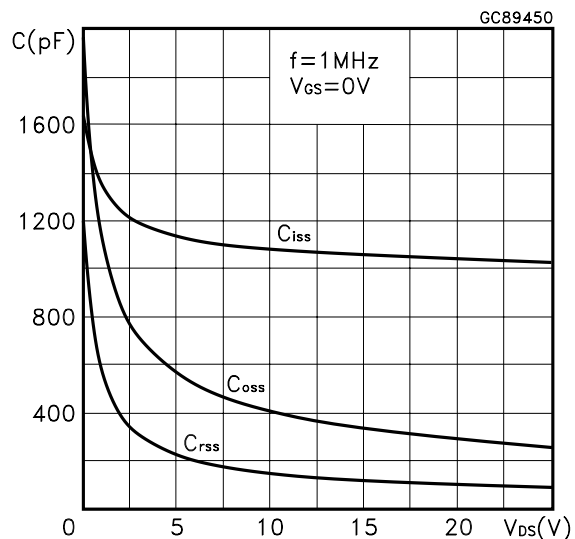

Normalized Gate Threshold Voltage vs Temperature **n-ch**

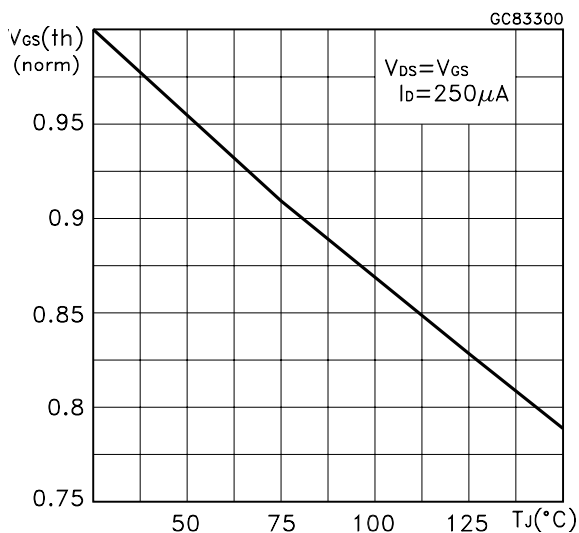

Normalized on Resistance vs Temperature **n-ch**

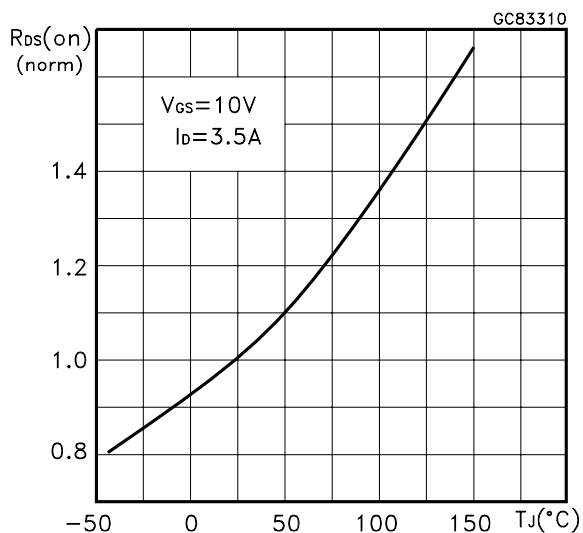

Source-drain Diode Forward Characteristics **n-ch**

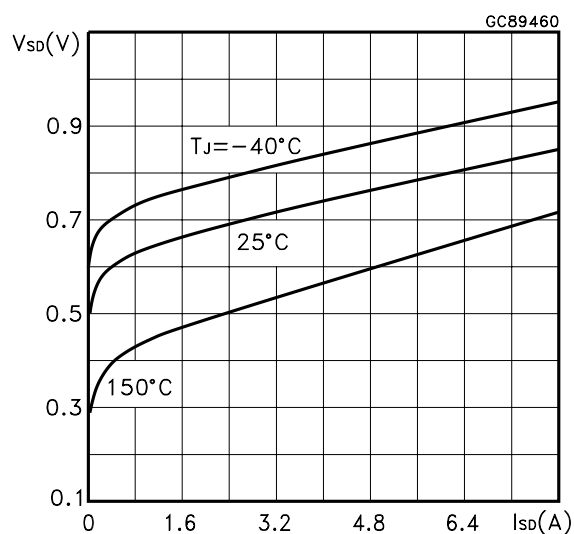

Safe Operating Area **p-ch**

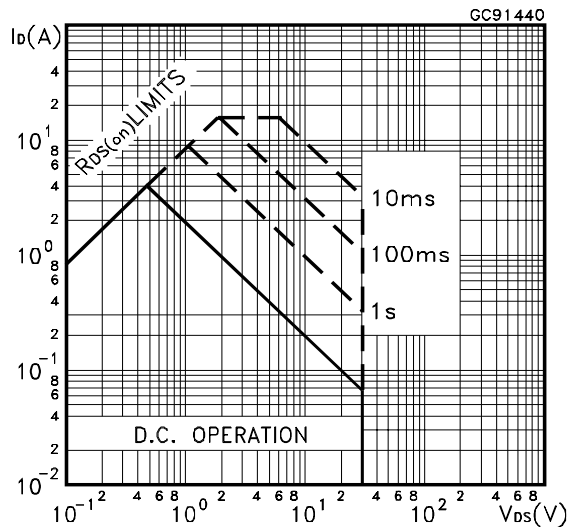

Thermal Impedance **p-ch**

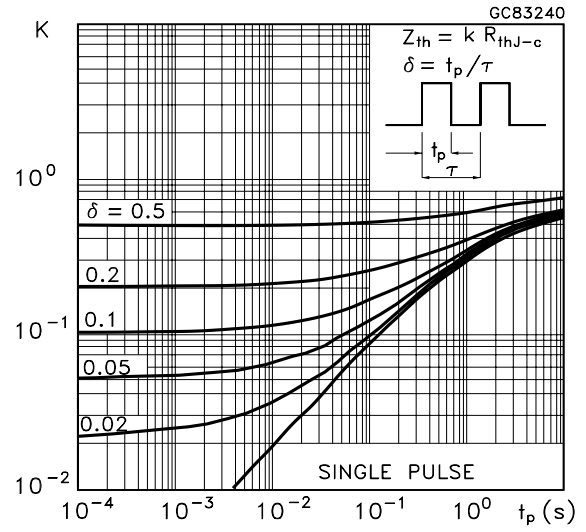

Output Characteristics **p-ch**

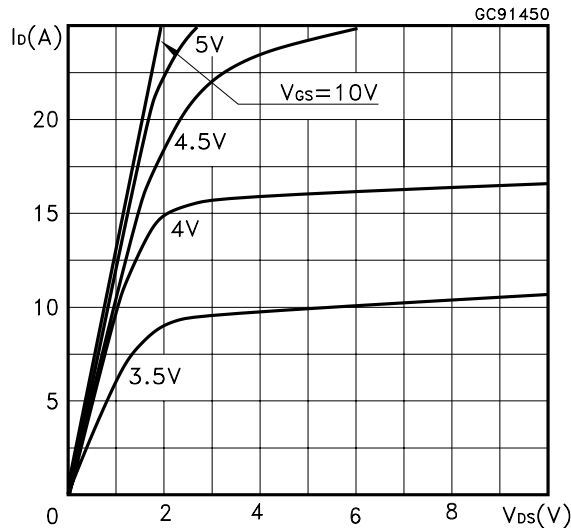

Transfer Characteristics **p-ch**

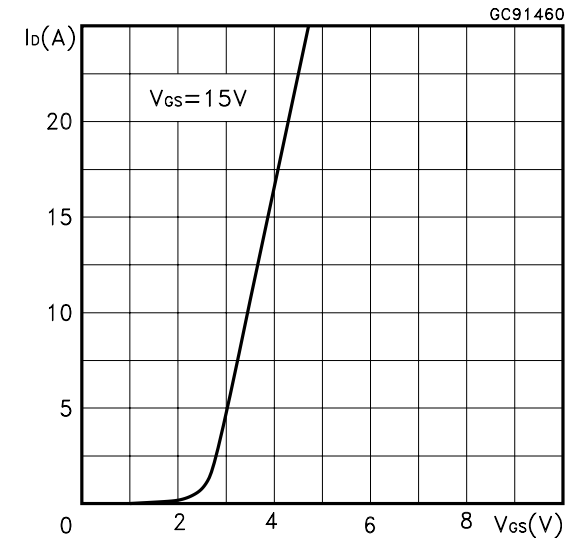

Transconductance **p-ch**

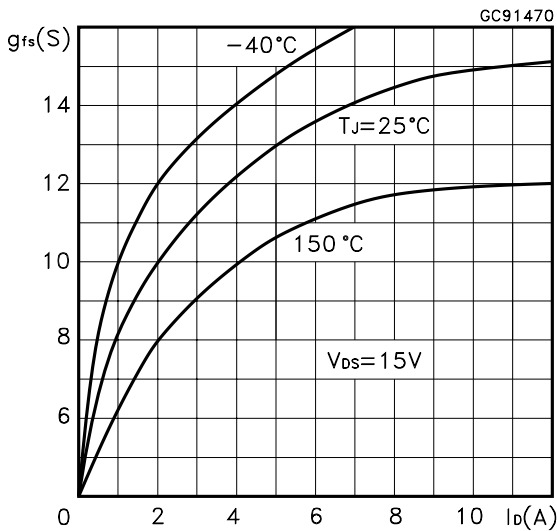

Static Drain-source On Resistance **p-ch**

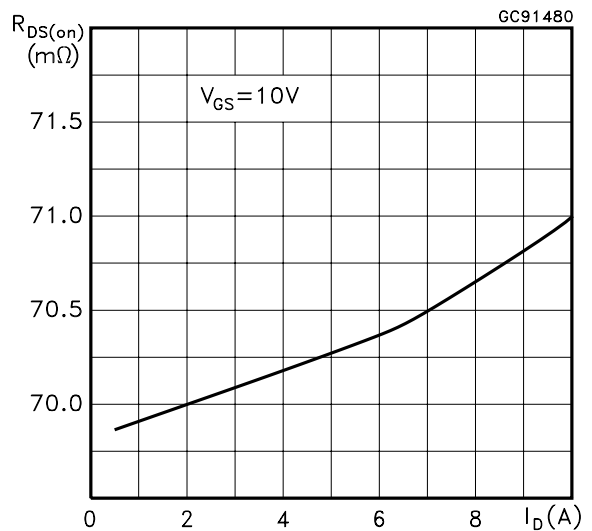

Gate Charge vs Gate-source Voltage **p-ch**

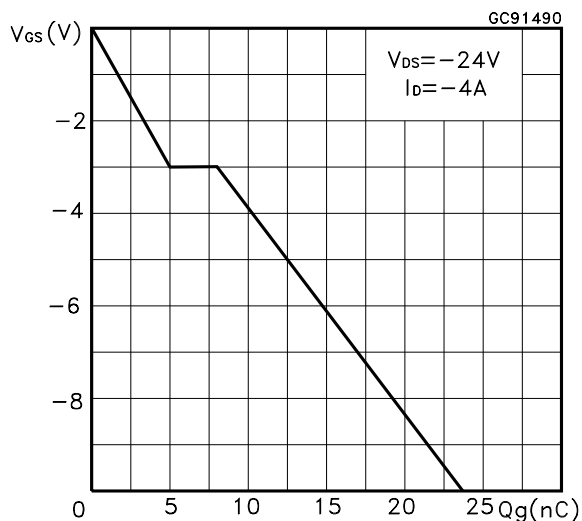

Capacitance Variations **p-ch**

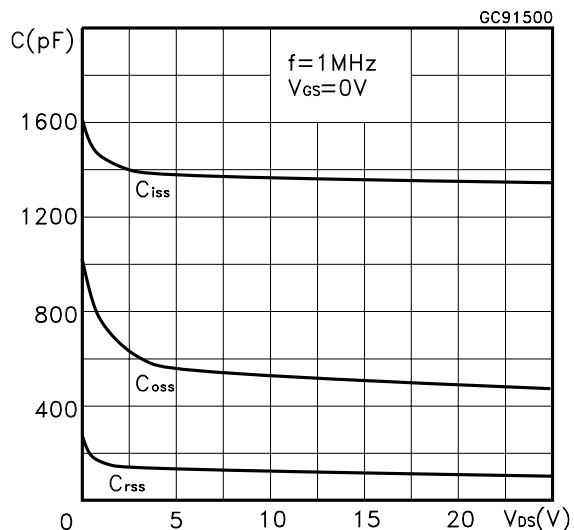

Normalized Gate Threshold Voltage vs Temperature **p-ch**

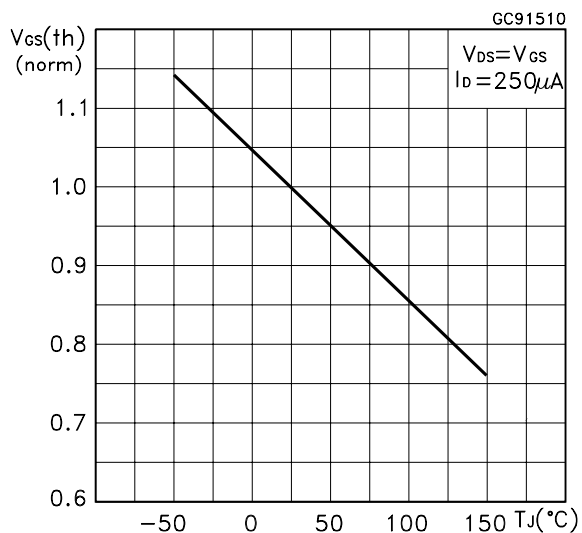

Normalized on Resistance vs Temperature **p-ch**

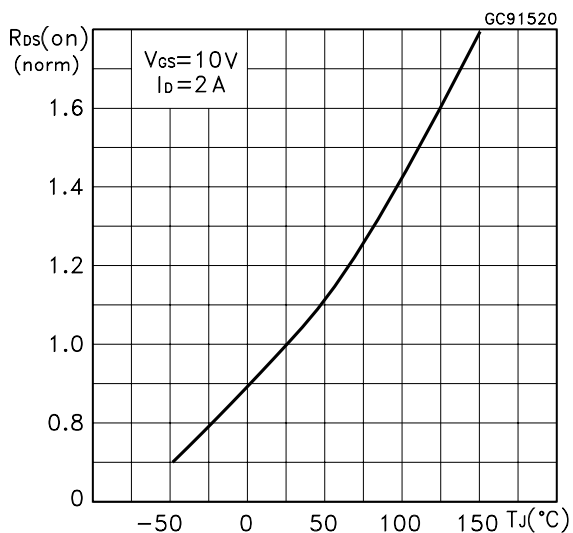

Source-drain Diode Forward Characteristics **p-ch**

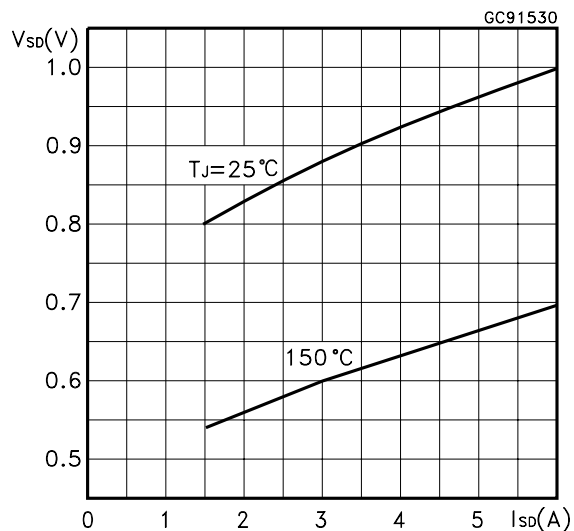

**Fig. 1: Switching Times Test Circuits For Resistive Load**

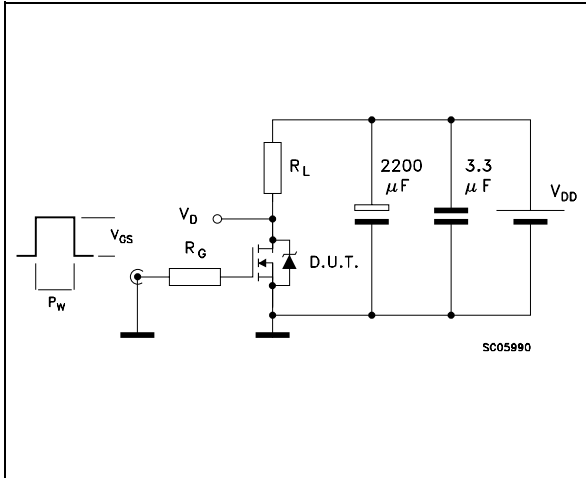

**Fig. 2: Gate Charge test Circuit**

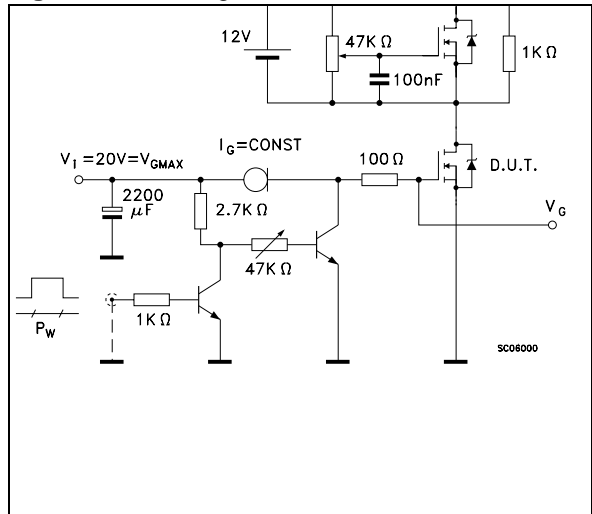

**Fig. 3: Test Circuit For Diode Recovery Behaviour**

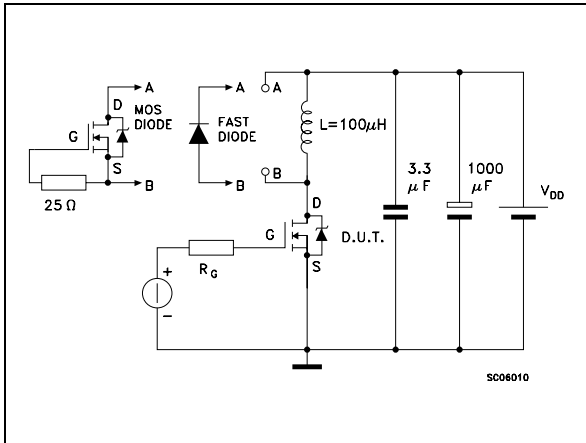



**SO-8 MECHANICAL DATA**

DIM.	mm			inch		
	MIN.	TYP.	MAX.	MIN.	TYP.	MAX.
A			1.75			0.068
a1	0.1		0.25	0.003		0.009
a2			1.65			0.064
a3	0.65		0.85	0.025		0.033
b	0.35		0.48	0.013		0.018
b1	0.19		0.25	0.007		0.010
C	0.25		0.5	0.010		0.019
c1	45 (typ.)					
D	4.8		5.0	0.188		0.196
E	5.8		6.2	0.228		0.244
e		1.27			0.050	
e3		3.81			0.150	
F	3.8		4.0	0.14		0.157
L	0.4		1.27	0.015		0.050
M			0.6			0.023
S	8 (max.)					

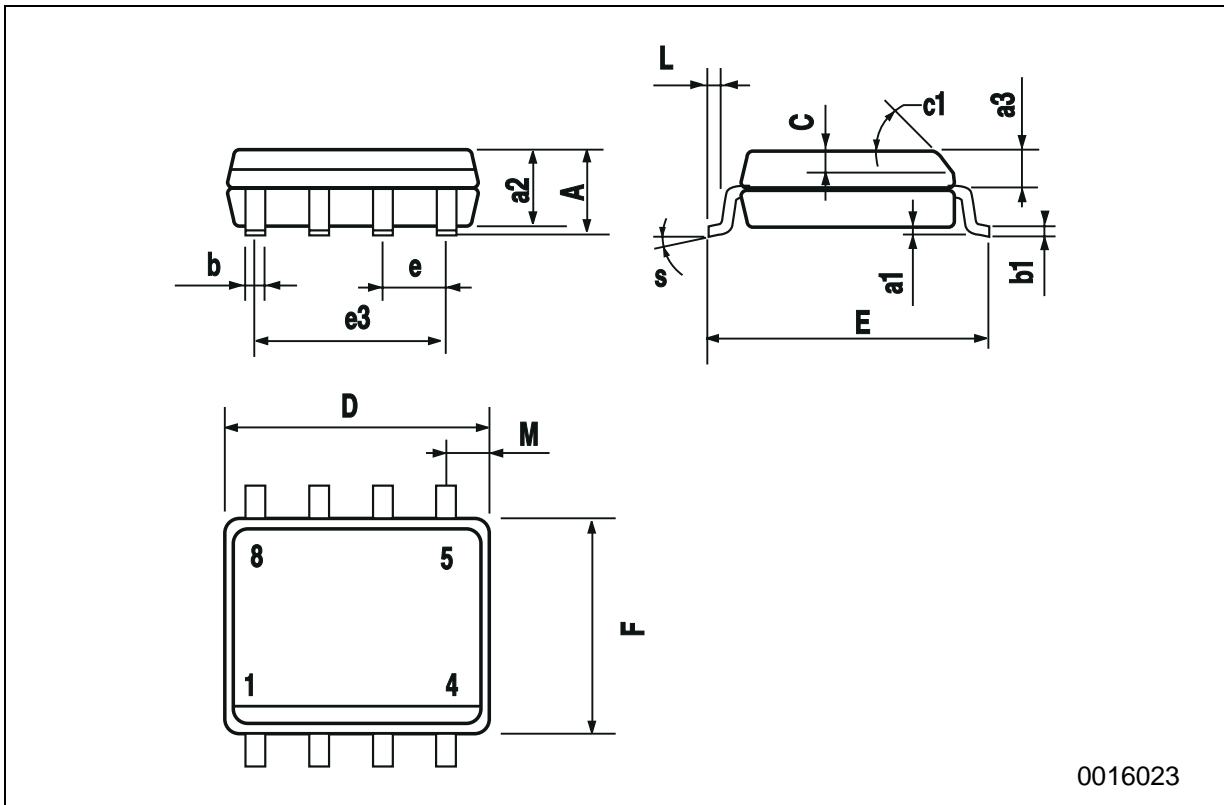

0016023

Information furnished is believed to be accurate and reliable. However, STMicroelectronics assumes no responsibility for the consequences of use of such information nor for any infringement of patents or other rights of third parties which may result from its use. No license is granted by implication or otherwise under any patent or patent rights of STMicroelectronics. Specifications mentioned in this publication are subject to change without notice. This publication supersedes and replaces all information previously supplied. STMicroelectronics products are not authorized for use as critical components in life support devices or systems without express written approval of STMicroelectronics.

The ST logo is registered trademark of STMicroelectronics  
© 2001 STMicroelectronics - All Rights Reserved

All other names are the property of their respective owners.

STMicroelectronics GROUP OF COMPANIES  
Australia - Brazil - China - Finland - France - Germany - Hong Kong - India - Italy - Japan - Malaysia - Malta - Morocco -  
Singapore - Spain - Sweden - Switzerland - United Kingdom - U.S.A.

<http://www.st.com>