

## GaAs MMIC SMT DOUBLE-BALANCED MIXER 1.6 - 3.4 GHz

FEBRUARY 2001

### Features

CONVERSION LOSS: 8.5 dB

LO/IF ISOLATION: 27 dB

LO/RF ISOLATION: 32 dB

### General Description

The HMC147S8 is a miniature double-balanced mixer in a plastic surface mount Small-Outline IC (SOIC) package. The device can be used as an upconverter or downconverter and is especially suitable for base station and portable wireless applications because of its small size and zero DC bias requirement. The mixer provides exceptional isolation and intermodulation performance for application in high signal density environments. This device can also be used as a biphasic modulator/demodulator, or Phase Comparator. See the smaller MSOP8 Packaged Equivalent mixer HMC175MS8.



4

MIXERS

SMT



### Guaranteed Performance With LO Drive of +13 dBm - 40 to + 85 deg. C

Parameter	Min.	Typ.	Max.	Min.	Typ.	Max.	Units
Frequency Range, RF & LO	1.85 -2.2			2.2 - 2.6			GHz
Frequency Range, IF	DC - 1.0			DC - 1.0			GHz
Conversion Loss		9	10		8.6	10	dB
Noise Figure (SSB)		9	10		8.6	10	dB
LO to RF Isolation	29	33		26	30		dB
LO to IF Isolation	24	28		22	26		dB
IP3 (Input)	15	18		15	18		dBm
1 dB Gain Compression (Input)	8	11		8	11		dBm
Local Oscillator Drive Level	10	13	15	10	13	15	dBm

## GaAs MMIC SMT DOUBLE-BALANCED MIXER 1.6 - 3.4 GHz

FEBRUARY 2001

### Conversion Loss

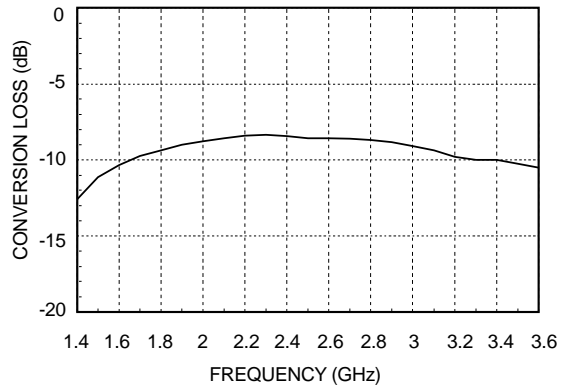

### Isolation

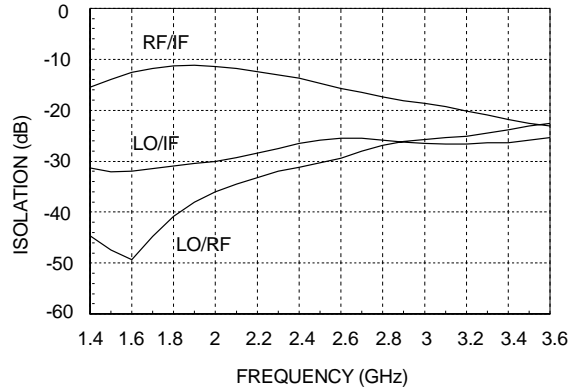

### Return Loss

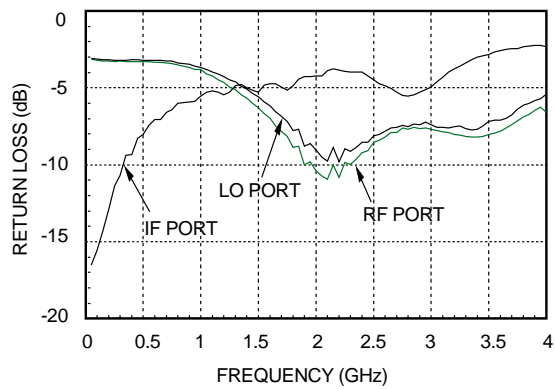

### Intermodulation Intercept @ 2 GHz

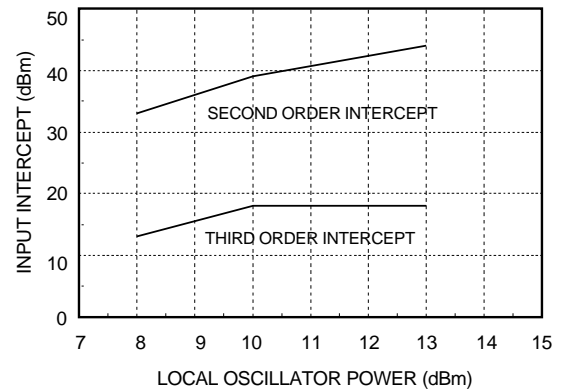

### Conversion Loss vs Lo Power

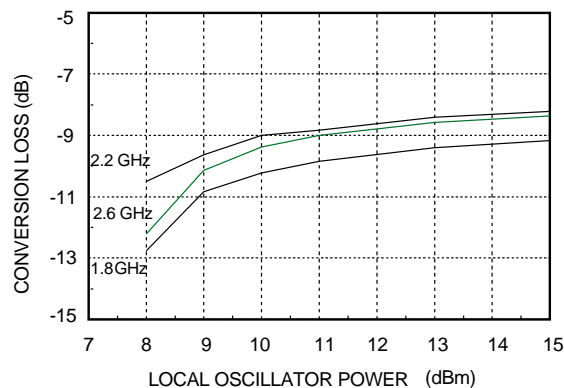

4  
SMT MIXERS



## GaAs MMIC SMT DOUBLE-BALANCED MIXER 1.6 - 3.4 GHz

FEBRUARY 2001

### Schematic

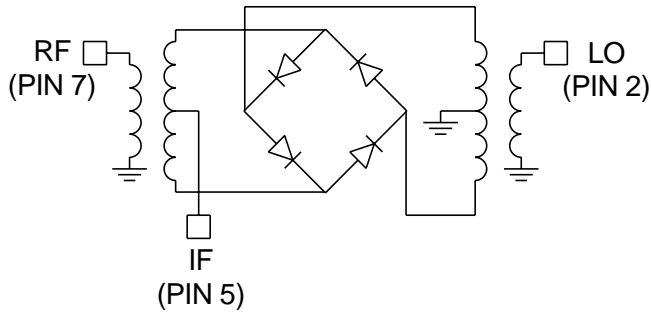

### Absolute Maximum Ratings

LO Drive	+27 dBm
Storage Temperature	-65 to +150 deg C
Operating Temperature	-40 to +85 deg C

### Outline Drawing

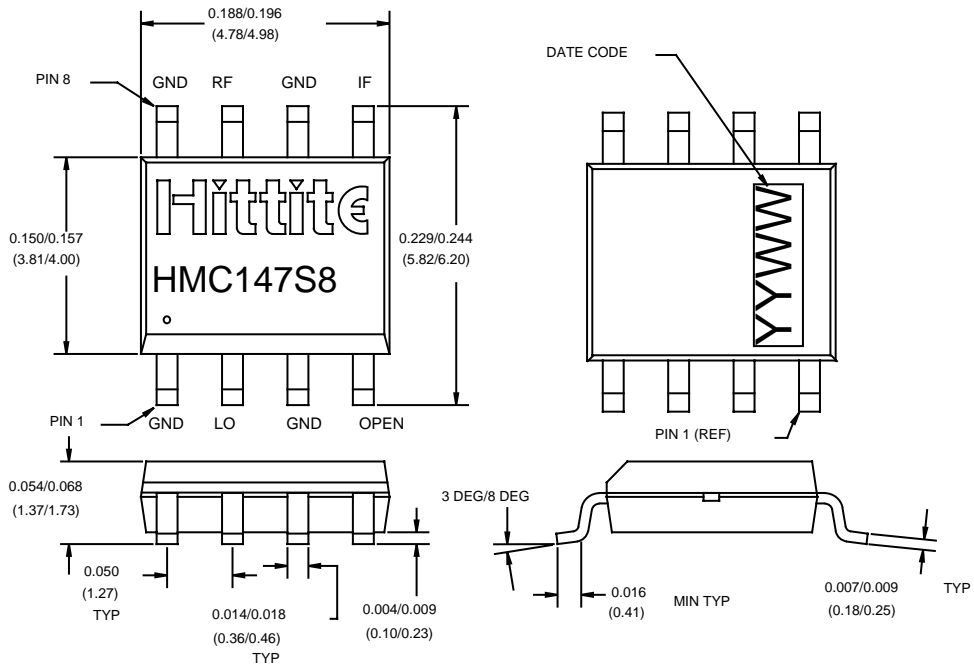

1. MATERIAL:
  - A) PACKAGE BODY - LOW STRESS INJECTION-MOLDED PLASTIC, SILICA & SILICONE IMPREGNATED.
  - B) LEADFRAME MATERIAL: COPPER ALLOY
2. PLATING: LEAD-TIN SOLDER PLATE
3. DIMENSIONS ARE IN INCHES (MILLIMETERS), UNLESS OTHERWISE SPECIFIED TOL. ARE  $\pm 0.005$  ( $\pm 0.13$ )



## GaAs MMIC SMT DOUBLE-BALANCED MIXER 1.6 - 3.4 GHz

FEBRUARY 2001

### *Evaluation Circuit Board*

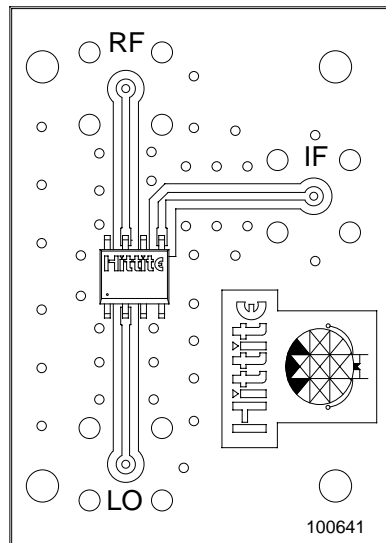

PC MOUNT SMA CONNECTORS  
IN THREE PLACES

The circuit board used in the final application should use RF circuit design techniques. Signal lines should have 50 ohm impedance while the package ground leads should be connected directly to the ground plane similar to that shown above. The evaluation circuit board as shown is available from Hittite upon request.

