

■ Features

- On-chip Hall sensor with two different sensitivity and hysteresis settings for ATS276/277
- 3.5V to 20V operating voltage
- 400mA (avg) output sink current
- Build-in protecting diode only for chip reverse power connecting
- -20°C to 85°C operating temperature
- Low profile 4 pin SIP package

■ Applications

- Dual-coil Brush-less DC Motor
- Dual-coil Brush-less DC Fan
- Revolution Counting
- Speed Measurement

■ General Description

ATS276/277 are integrated Hall sensors with output drivers, mainly designed for electronic commutation of brush-less DC Fan. This IC internally includes the regulator, protecting diode, Hall plate, amplifier, comparator, and a pair of complementary open-collector outputs (**DO**, **DOB**).

While the magnetic flux density (**B**) is larger than operate point (**Bop**), **DO** will turn on (low), and meanwhile **DOB** will turn off (high). Each output is latched until **B** is lower than release point (**Brp**), and then **DO** & **DOB** transfer each state.

For DC fan application, sometimes need to test power reverse connection condition. Internal diode only protects chip-side but not for coil-side. If necessary, add one external diode to block the reverse current from coil-side.

■ Ordering Information

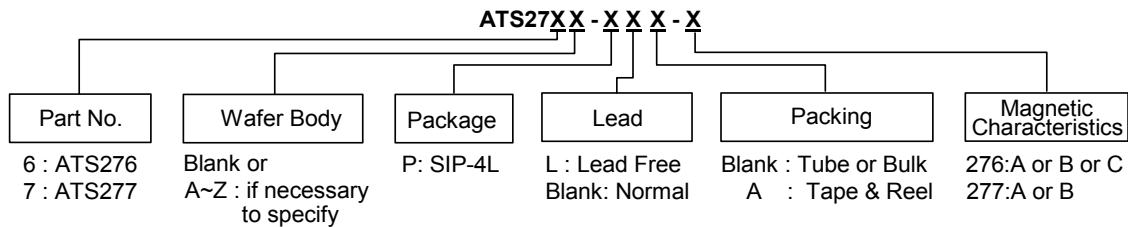

■ Typical Application Circuit

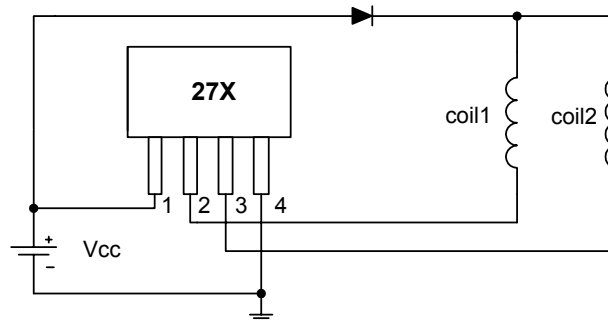

Brush-less DC Fan

■ **Block Diagram**

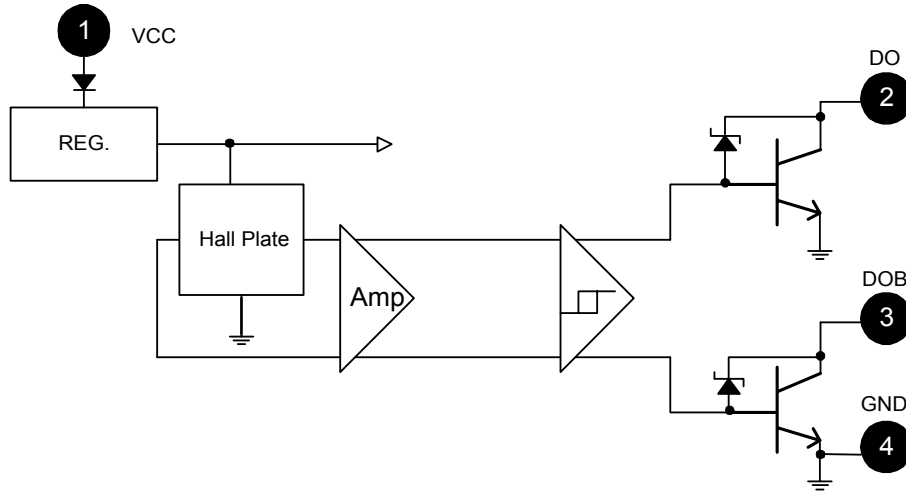

■ **Pin Assignment**

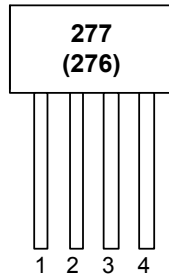

Front View

1 : VCC

2 : DO

3 : DOB

4 : GND

Name	P/I/O	Pin #	Description
Vcc	P	1	Power Supply Input
DO	O	2	Output Pin
DOB	O	3	Output Pin
GND	P	4	Ground

■ **Absolute Maximum Ratings** (at $T_a=25^{\circ}\text{C}$)

Characteristics		Symbol	Values	Unit
Supply voltage		V_{CC}	20	V
Reverse V_{CC} Polarity Voltage		V_{RCC}	-20	V
Magnetic flux density		B	Unlimited	
Output "on" current	Continuous	I_c	0.4	A
	Hold		0.5	
	Peak (Start Up)		0.7	
Operating temperature range		T_a	-20~+85	$^{\circ}\text{C}$
Storage temperature range		T_s	-65~+150	$^{\circ}\text{C}$
Package Power Dissipation		PD	550	mW
Maximum Junction Temp		T_j	150	$^{\circ}\text{C}$

■ **Electrical Characteristics** ($T=+25^{\circ}\text{C}$ $V_{CC} = 4.0\text{V}$ to 20V)

Characteristic	Symbol	Conditions	Min	Typ	Max	Units
Low Supply Voltage	Vce	$V_{CC}=3.5\text{V}$, $I_L=100\text{mA}$		0.4		V
Supply Voltage	V_{CC}		3.5		20	V
Output Zener Breakdown	V_z			46		V
Output Saturation Voltage	$V_{ce(sat)}$	$V_{CC}=14\text{V}$, $I_L=300\text{mA}$		0.3	0.6	V
Output Leakage Current	I_{cex}	$V_{ce}=14\text{V}$, $V_{CC}=14\text{V}$		<0.1	10	μA
Supply Current	I_{CC}	$V_{CC}=20\text{V}$, Output Open		16	25	mA
Output Rise Time	t_r	$V_{CC}=14\text{V}$, $R_L=820\Omega$, $C_L=20\text{pF}$		3.0	10	μs
Output Falling Time	t_f	$V_{CC}=14\text{V}$, $R_L=820\Omega$, $C_L=20\text{pF}$		0.3	1.5	μs
Switch Time Differential	Δt	$V_{CC}=14\text{V}$, $R_L=820\Omega$, $C_L=20\text{pF}$		3.0	10	μs

■ **Test Circuit**

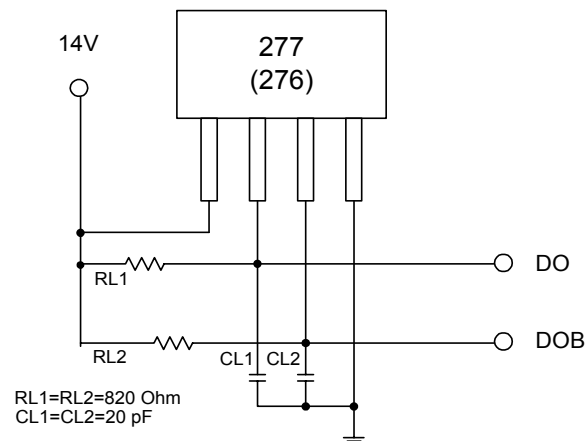

■ **Magnetic Characteristics(Ta=+25°C)**

(1mT=10 Gauss)

A grade

Characteristic		Symbol	Min.	Typ.	Max.	Unit
Operate Point	ATS276	Bop	10	-	50	Gauss
	ATS277		10	-	50	
Release Point	ATS276	Brp	-50	-	-10	Gauss
	ATS277		-50	-	-10	
Hysteresis	ATS276	Bhy	-	75	-	Gauss
	ATS277		-	75	-	

B grade

Characteristic		Symbol	Min.	Typ.	Max.	Unit
Operate Point	ATS276	Bop	5	-	70	Gauss
	ATS277		5	-	70	
Release Point	ATS276	Brp	-70	-	-5	Gauss
	ATS277		-70	-	-5	
Hysteresis	ATS276	Bhy	-	75	-	Gauss
	ATS277		-	75	-	

C grade

Characteristic		Symbol	Min.	Typ.	Max.	Unit
Operate Point	ATS276	Bop	-	-	100	Gauss
Release Point	ATS276	Brp	-100	-	-	Gauss
Hysteresis	ATS276	Bhy	-	75	-	Gauss

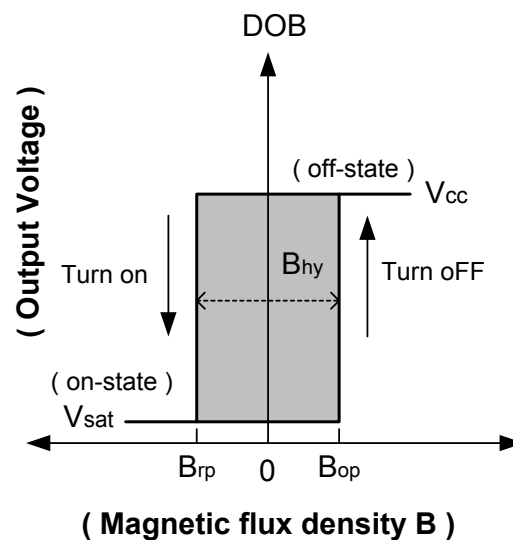
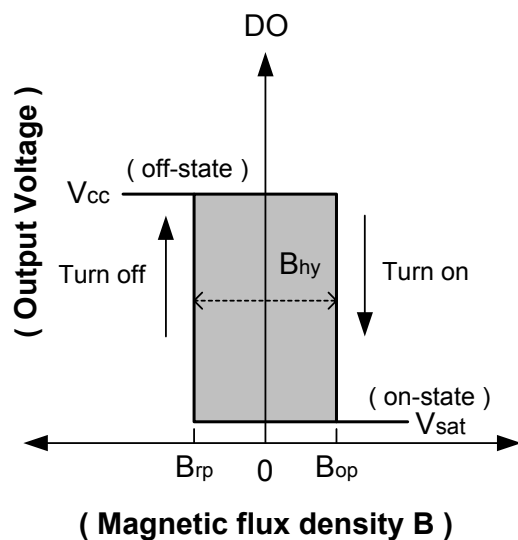

■ Performance Characteristics (SIP4)

Ta (°C)	25	50	60	70	80	85	90	95	100	105	110	115	120
Pd (mW)	550	440	396	352	308	286	264	242	220	198	176	154	132

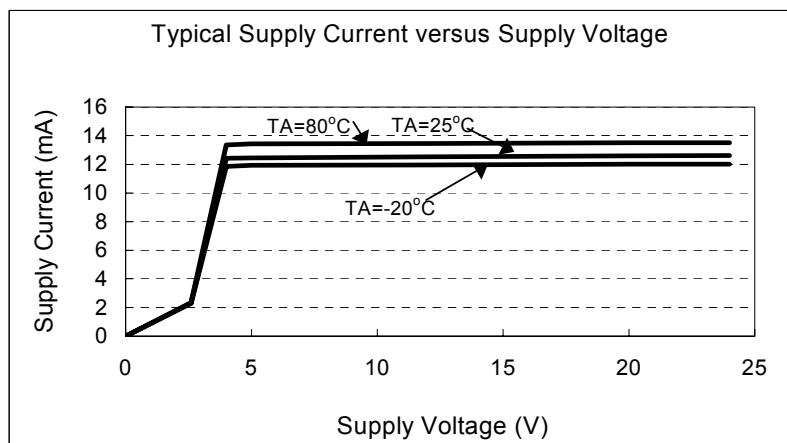
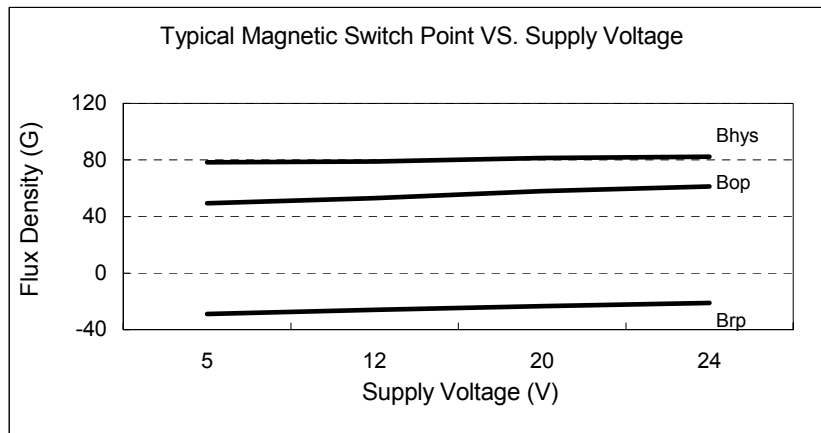
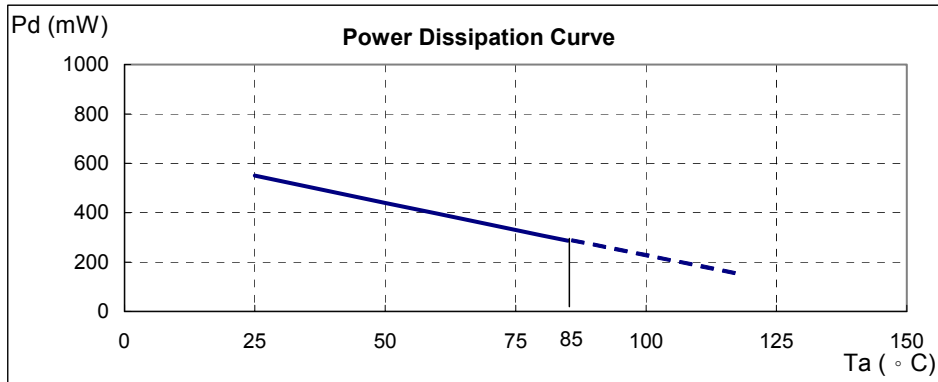

■ **Operating Characteristics**

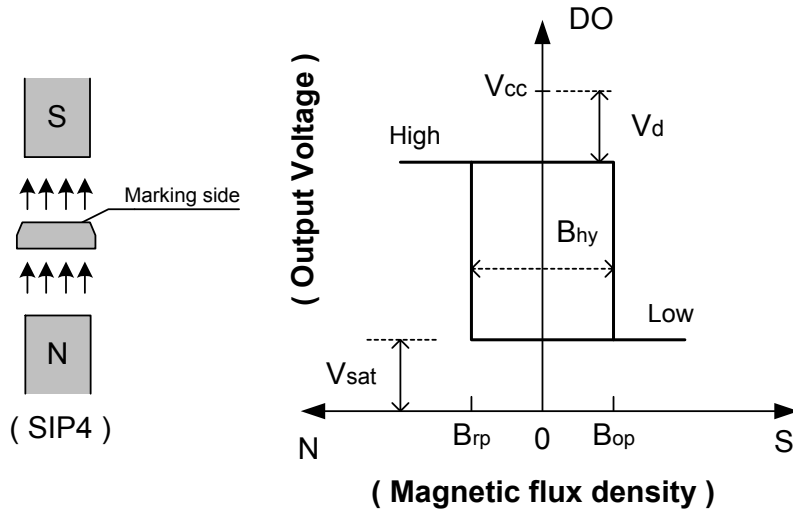

■ **Marking Information**

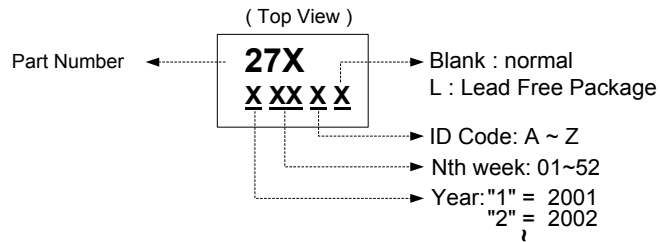

■ Package Information

Active Area Depth

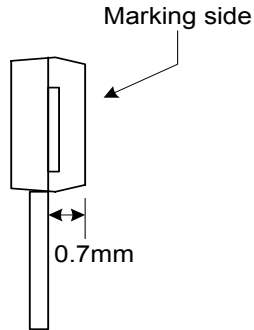

Package Sensor Location

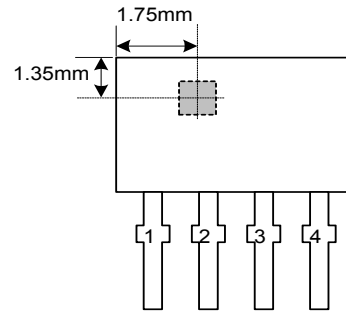

Package Dimension

