

# Interface and switching (30V, 200mA)

## 2SK2731

### ●Features

- 1) Low on-resistance.
- 2) Fast switching speed.
- 3) Low-voltage drive (4V).
- 4) Easily designed drive circuits.
- 5) Easy to parallel.

### ●Structure

Silicon N-channel  
MOSFET

### ●External dimensions (Units: mm)

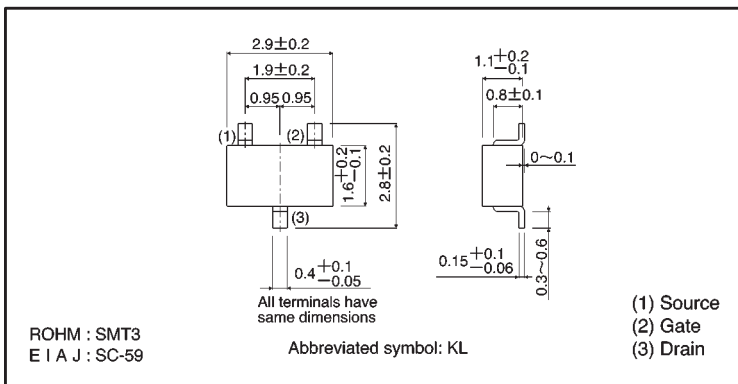

### ●Absolute maximum ratings (Ta = 25°C)

Parameter	Symbol	Limits	Unit
Drain-source voltage	V <sub>DSS</sub>	30	V
Gate-source voltage	V <sub>GSS</sub>	±20	V
Drain current	Continuous	I <sub>D</sub>	200 mA
	Pulsed	I <sub>DP</sub> *	800 mA
Reverse drain current	Continuous	I <sub>DR</sub>	200 mA
	Pulsed	I <sub>DRP</sub> *	800 mA
Total power dissipation	P <sub>D</sub>	200	mW
Channel temperature	T <sub>ch</sub>	150	°C
Storage temperature	T <sub>stg</sub>	-55~+150	°C

\* P<sub>w</sub> ≤ 10 μs, Duty cycle ≤ 1%

### ●Equivalent circuit

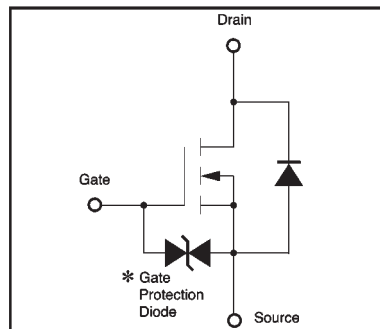

\* A protection diode is included between the gate and the source terminals to protect the diode against static electricity when the product is in use. Use a protection circuit when the fixed voltage are exceeded.

●Electrical characteristics (Ta = 25°C)

Parameter	Symbol	Min.	Typ.	Max.	Unit	Test Conditions
Gate-source leakage	$I_{GSS}$	—	—	$\pm 10$	$\mu A$	$V_{GS} = \pm 20V, V_{DS} = 0V$
Drain-source breakdown voltage	$V_{(BR)DSS}$	30	—	—	V	$I_D = 1mA, V_{GS} = 0V$
Zero gate voltage drain current	$I_{DSS}$	—	—	10	$\mu A$	$V_{DS} = 30V, V_{GS} = 0V$
Gate threshold voltage	$V_{GS(th)}$	1.0	—	2.5	V	$V_{DS} = 10V, I_D = 1mA$
Static drain-source on-state resistance	$R_{DS(on)}$	—	1.5	2.8	$\Omega$	$I_D = 0.1A, V_{GS} = 10V$
		—	2.8	4.5		$I_D = 0.1A, V_{GS} = 4V$
Forward transfer admittance	$ Y_{fs} ^{*}$	100	—	—	mS	$I_D = 0.1A, V_{DS} = 10V$
Input capacitance	$C_{iss}$	—	25	—	pF	$V_{DS} = 10V$
Output capacitance	$C_{oss}$	—	15	—	pF	$V_{GS} = 0V$
Reverse transfer capacitance	$C_{rss}$	—	10	—	pF	$f = 1MHz$
Turn-on delay time	$t_d(on)$	—	15	—	ns	$I_D = 0.1A, V_{DD} \approx 15V$
Rise time	$t_r$	—	20	—	ns	$V_{GS} = 10V$
Turn-off delay time	$t_d(off)$	—	90	—	ns	$R_L = 150\Omega$
Fall time	$t_f$	—	100	—	ns	$R_G = 10\Omega$

\*  $P_w \leq 300 \mu s$ , Duty cycle  $\leq 1\%$

●Packaging specifications

Type	Package	Taping
	Code	T146
	Basic ordering unit (pieces)	3000
2SK2731		○

●Electrical characteristic curves

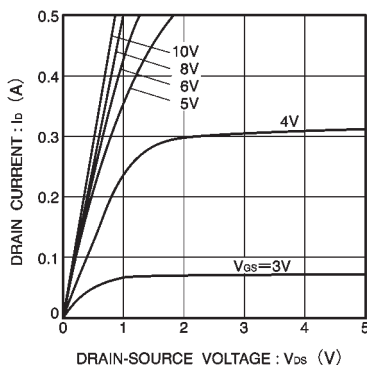

Fig.1 Typical output characteristics

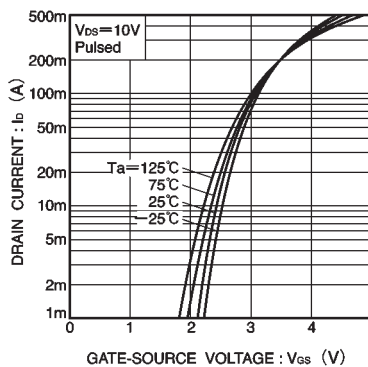

Fig.2 Typical transfer characteristics

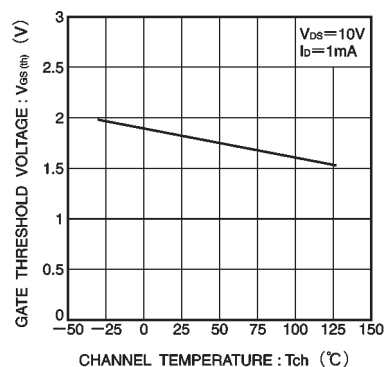

Fig.3 Gate threshold voltage vs. channel temperature

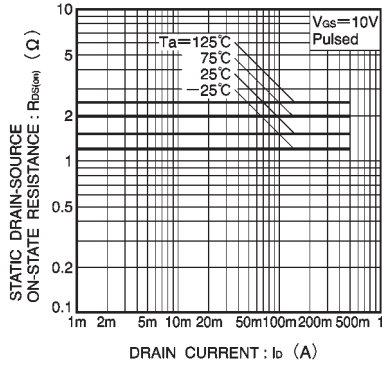

Fig.4 Static drain-source on-state resistance vs. drain current ( I )

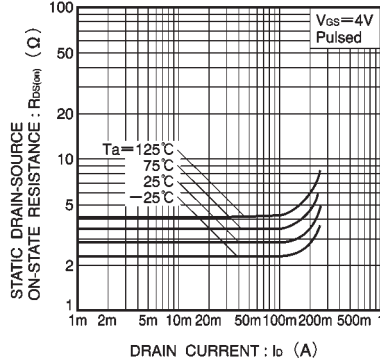

Fig.5 Static drain-source on-state resistance vs. drain current ( II )

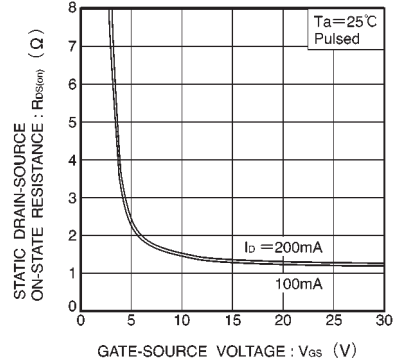

Fig.6 Static drain-source on-state resistance vs. gate-source voltage

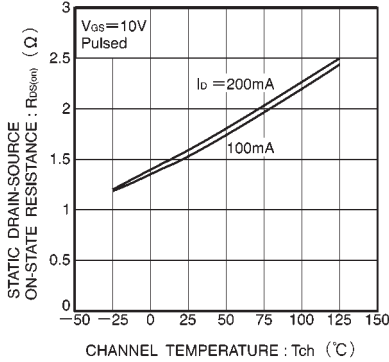

Fig.7 Static drain-source on-state resistance vs. channel temperature

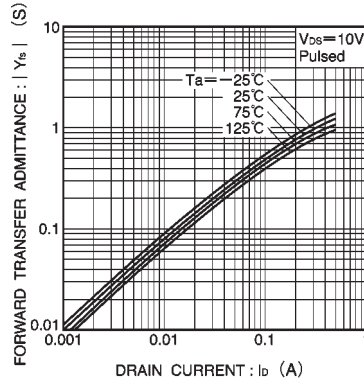

Fig.8 Forward transfer admittance vs. drain current

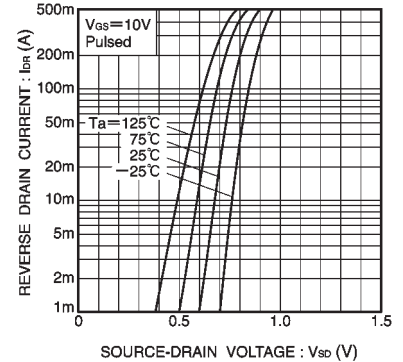

Fig.9 Reverse drain current vs. source-drain voltage ( I )

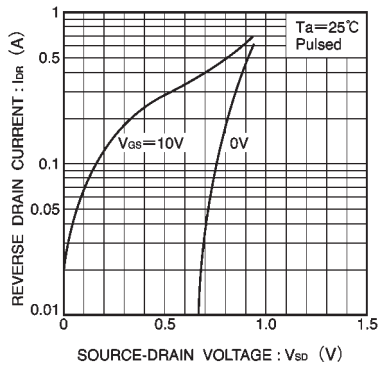

Fig.10 Reverse drain current vs. source-drain voltage ( II )

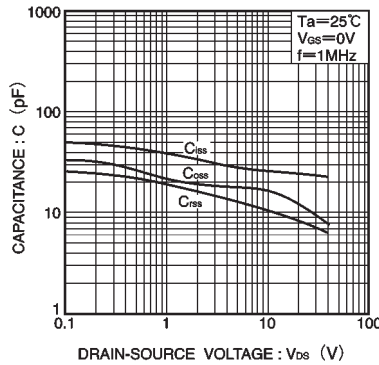

Fig.11 Typical capacitance vs. drain-source voltage

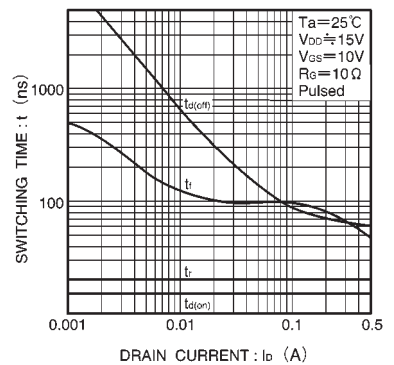

Fig.12 Switching characteristics ( See Figures 13 and 14 for the measurement circuit and resultant waveforms )

● Switching characteristics measurement circuit

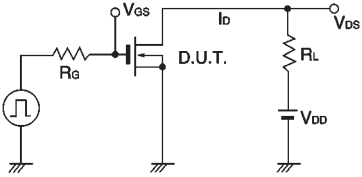

Fig.13 Switching time measurement circuit

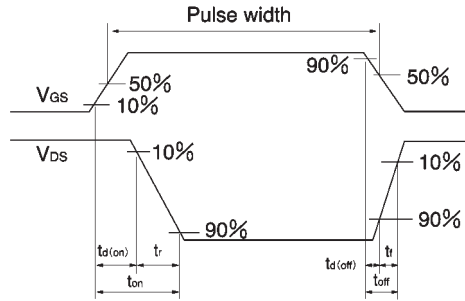

Fig.14 Switching time waveforms