

FEATURES

- AD5253: Quad 64-position resolution**
- AD5254: Quad 256-position resolution**
- 1 k Ω , 10 k Ω , 50 k Ω , 100 k Ω**
- Nonvolatile memory¹ stores wiper settings with write protection**
- Power-on refreshed to EEMEM settings in 300 μ s typ**
- EEMEM rewrite time = 540 μ s typ**
- Resistance tolerance stored in nonvolatile memory**
- 12 extra bytes in EEMEM for user-defined information**
- I²C[®] compatible serial interface**
- Direct read/write accesses of RDAC² and EEMEM registers**
- Predefined linear increment/decrement commands**
- Predefined ± 6 dB step change commands**
- Synchronous or asynchronous quad channel update**
- Wiper setting readback**
- 4 MHz bandwidth—1 k Ω version**
- Single supply 2.7 V to 5.5 V**
- Dual supply ± 2.25 V to ± 2.75 V**
- 2 slave address decoding bits allow operation of 4 devices**
- 100-year typical data retention, T_A = 55°C**
- Operating temperature: -40°C to +85°C**

APPLICATIONS

- Mechanical potentiometer replacement**
- Low resolution DAC replacement**
- RGB LED backlight control**
- White LED brightness adjustment**
- RF base station power amp bias control**
- Programmable gain and offset control**
- Programmable attenuators**
- Programmable voltage-to-current conversion**
- Programmable power supply**
- Programmable filters**
- Sensor calibrations**

GENERAL DESCRIPTION

The AD5253/AD5254 are quad channel, I²C, nonvolatile memory, digitally controlled potentiometers with 64/256 positions, respectively. These devices perform the same electronic adjustment functions as mechanical potentiometers, trimmers, and variable resistors.

The AD5253/AD5254's versatile programmability allows multiple modes of operation, including read/write accesses in the RDAC and EEMEM registers, increment/decrement of resistance, resistance changes in ± 6 dB scales, wiper setting readback, and extra EEMEM for storing user-defined information, such as memory data for other components, look-up table, or system identification information.

Rev. 0

Information furnished by Analog Devices is believed to be accurate and reliable. However, no responsibility is assumed by Analog Devices for its use, nor for any infringements of patents or other rights of third parties that may result from its use. Specifications subject to change without notice. No license is granted by implication or otherwise under any patent or patent rights of Analog Devices. Trademarks and registered trademarks are the property of their respective owners.

FUNCTIONAL BLOCK DIAGRAM

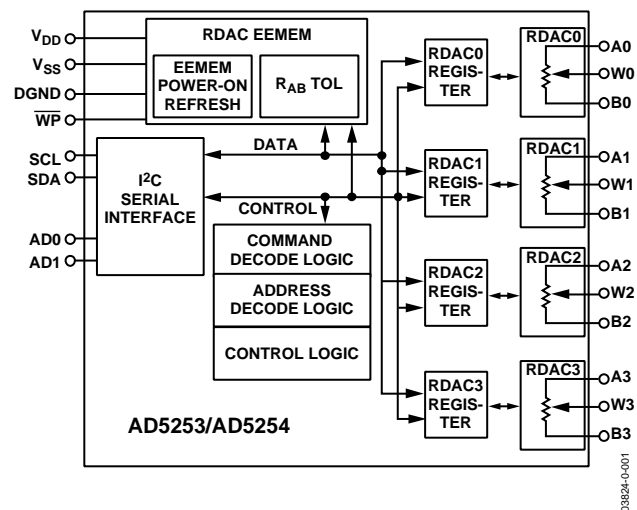

Figure 1.

The AD5253/AD5254 allow the host I²C controllers to write any of the 64-/256-step wiper settings in the RDAC registers and store them in the EEMEM. Once the settings are stored, they are restored automatically to the RDAC registers at system power-on; the settings can also be restored dynamically.

The AD5253/AD5254 provide additional increment, decrement, +6 dB step change, and -6 dB step change in synchronous or asynchronous channel update modes. The increment and decrement functions allow stepwise linear adjustments, while ± 6 dB step changes are equivalent to doubling or halving the RDAC wiper setting. These functions are useful for steep-slope nonlinear adjustment applications such as white LED brightness and audio volume control.

The AD5253/AD5254 have a patented resistance tolerance storing function that allows the user to access the EEMEM and obtain the absolute end-to-end resistance values of the RDACs for precision applications.

The AD5253/AD5254 are available in TSSOP-20 packages in 1 k Ω , 10 k Ω , 50 k Ω , and 100 k Ω options. All parts are guaranteed to operate over the -40°C to +85°C extended industrial temperature range.

¹The terms nonvolatile memory and EEMEM are used interchangeably.
²The terms digital potentiometer and RDAC are used interchangeably.

TABLE OF CONTENTS

Electrical Characteristics	3	±6 dB Adjustments (Doubling/Halving Wiper Setting).....	20
1 kΩ Version.....	3	Digital Input/Output Configuration.....	21
10 kΩ, 50 kΩ, 100 kΩ Versions	5	Multiple Devices On One Bus	21
Interface Timing Characteristics (All Parts).....	7	Terminal Voltage Operation Range	22
Absolute Maximum Ratings.....	8	Power-Up and Power-Down Sequences.....	22
ESD Caution.....	8	Layout and Power Supply Biasing	22
Pin Configuration and Functional Descriptions.....	9	Digital Potentiometer Operation	23
Typical Performance Characteristics	10	Programmable Rheostat Operation	23
I ² C Interface.....	14	Programmable Potentiometer Operation	24
I ² C Interface General Description.....	14	Applications.....	25
I ² C Interface Detail Description.....	15	RGB LED LCD Backlight Controller.....	25
I ² C Compatible 2-Wire Serial Bus.....	19	Outline Dimensions	27
Theory of Operation	20	Ordering Guide	27
Linear Increment and Decrement Commands	20		

REVISION HISTORY

Revision 0: Initial Version

ELECTRICAL CHARACTERISTICS

1 k Ω VERSION

$V_{DD} = +3\text{ V} \pm 10\%$ or $+5\text{ V} \pm 10\%$, $V_{SS} = 0\text{ V}$ or $V_{DD}/V_{SS} = \pm 2.5\text{ V} \pm 10\%$, $V_A = +V_{DD}$, $V_B = 0\text{ V}$, $-40^\circ\text{C} < T_A < +85^\circ\text{C}$, unless otherwise noted.

Table 1.

Parameter	Symbol	Conditions	Min	Typ ¹	Max	Unit
DC CHARACTERISTICS—RHEOSTAT MODE						
Resolution	N	AD5253/AD5254			6/8	Bits
Resistor Differential Nonlinearity ²	R-DNL	$R_{WB}, R_{WA} = \text{NC}, V_{DD} = 5.5\text{ V}$, AD5253 $R_{WB}, R_{WA} = \text{NC}, V_{DD} = 5.5\text{ V}$, AD5254	-0.5	± 0.2	+0.5	LSB
		$R_{WB}, R_{WA} = \text{NC}, V_{DD} = 2.7\text{ V}$, AD5253 $R_{WB}, R_{WA} = \text{NC}, V_{DD} = 2.7\text{ V}$, AD5254	-1	± 0.25	+1	LSB
		$R_{WB}, R_{WA} = \text{NC}, V_{DD} = 2.7\text{ V}$, AD5253 $R_{WB}, R_{WA} = \text{NC}, V_{DD} = 2.7\text{ V}$, AD5254	-0.75	± 0.3	+0.75	LSB
Resistor Nonlinearity ²	R-INL	$R_{WB}, R_{WA} = \text{NC}, V_{DD} = 2.7\text{ V}$, AD5253 $R_{WB}, R_{WA} = \text{NC}, V_{DD} = 5.5\text{ V}$, AD5253	-1.5	± 0.3	+1.5	LSB
		$R_{WB}, R_{WA} = \text{NC}, V_{DD} = 5.5\text{ V}$, AD5254 $R_{WB}, R_{WA} = \text{NC}, V_{DD} = 5.5\text{ V}$, AD5254	-0.5	± 0.2	+0.5	LSB
		$R_{WB}, R_{WA} = \text{NC}, V_{DD} = 2.7\text{ V}$, AD5253 $R_{WB}, R_{WA} = \text{NC}, V_{DD} = 2.7\text{ V}$, AD5254	-2	± 0.5	+2	LSB
		$R_{WB}, R_{WA} = \text{NC}, V_{DD} = 2.7\text{ V}$, AD5253 $R_{WB}, R_{WA} = \text{NC}, V_{DD} = 2.7\text{ V}$, AD5254	-1	+2.5	+4	LSB
Nominal Resistor Tolerance	$\Delta R_{AB}/R_{AB}$	$T_A = 25^\circ\text{C}$	-2	+9	+14	LSB
Resistance Temperature Coefficient	$(\Delta R_{AB}/R_{AB}) \times 10^6/\Delta T$		-30		+30	%
Wiper Resistance	R_W	$I_W = 1\text{ V/R}, V_{DD} = 5\text{ V}$ $I_W = 1\text{ V/R}, V_{DD} = 3\text{ V}$		75	130	Ω
				200	300	Ω
Channel Resistance Matching	$\Delta R_{AB1}/\Delta R_{AB2}$			0.15		%
DC CHARACTERISTICS—POTENTIOMETER DIVIDER MODE						
Differential Nonlinearity ³	DNL	AD5253 AD5254	-0.5	± 0.1	+0.5	LSB
		AD5253 AD5254	-1	± 0.25	+1	LSB
Integral Nonlinearity ³	INL	AD5253 AD5254	-0.5	± 0.2	+0.5	LSB
		AD5254	-2	± 0.5	+2	LSB
Voltage Divider Temperature Coefficient	$(\Delta V_W/V_W) \times 10^6/\Delta T$	Code = Half scale		25		ppm/ $^\circ\text{C}$
Full-Scale Error	V_{WFSE}	Code = Full scale, $V_{DD} = 5.5\text{ V}$, AD5253 Code = Full scale, $V_{DD} = 5.5\text{ V}$, AD5254 Code = Full scale, $V_{DD} = 2.7\text{ V}$, AD5253 Code = Full scale, $V_{DD} = 2.7\text{ V}$, AD5254	-5	-3	0	LSB
		Code = Full scale, $V_{DD} = 2.7\text{ V}$, AD5254	-16	-11	0	LSB
		Code = Full scale, $V_{DD} = 2.7\text{ V}$, AD5254	-6	-4	0	LSB
		Code = Full scale, $V_{DD} = 2.7\text{ V}$, AD5254	-23	-16	0	LSB
Zero-Scale Error	V_{WZSE}	Code = Zero scale, $V_{DD} = 5.5\text{ V}$, AD5253 Code = Zero scale, $V_{DD} = 5.5\text{ V}$, AD5254 Code = Zero scale, $V_{DD} = 2.7\text{ V}$, AD5253 Code = Zero scale, $V_{DD} = 2.7\text{ V}$, AD5254	0	3	5	LSB
		Code = Zero scale, $V_{DD} = 5.5\text{ V}$, AD5254	0	11	16	LSB
		Code = Zero scale, $V_{DD} = 2.7\text{ V}$, AD5253	0	4	6	LSB
		Code = Zero scale, $V_{DD} = 2.7\text{ V}$, AD5254	0	15	20	LSB
RESISTOR TERMINALS						
Voltage Range ⁴	V_A, V_B, V_W		V_{SS}		V_{DD}	V
Capacitance ⁵ Ax, Bx	C_A, C_B	$f = 1\text{ kHz}$, measured to GND, Code = Half scale		85		pF
Capacitance ⁵ Wx	C_W	$f = 1\text{ kHz}$, measured to GND, Code = Half scale		95		pF
Common-Mode Leakage Current	I_{CM}	$V_A = V_B = V_{DD}/2$		0.01	1	μA
DIGITAL INPUTS AND OUTPUTS						
Input Logic High	V_{IH}	$V_{DD} = 5\text{ V}, V_{SS} = 0\text{ V}$ $V_{DD}/V_{SS} = +2.7\text{ V}/0\text{ V}$ or $V_{DD}/V_{SS} = \pm 2.5\text{ V}$	2.4			V
		$V_{DD} = 5\text{ V}, V_{SS} = 0\text{ V}$ $V_{DD}/V_{SS} = +2.7\text{ V}/0\text{ V}$ or $V_{DD}/V_{SS} = \pm 2.5\text{ V}$	2.1			V
Input Logic Low	V_{IL}	$V_{DD} = 5\text{ V}, V_{SS} = 0\text{ V}$ $V_{DD}/V_{SS} = +2.7\text{ V}/0\text{ V}$ or $V_{DD}/V_{SS} = \pm 2.5\text{ V}$			0.8	V
		$V_{DD} = 5\text{ V}, V_{SS} = 0\text{ V}$ $V_{DD}/V_{SS} = +2.7\text{ V}/0\text{ V}$ or $V_{DD}/V_{SS} = \pm 2.5\text{ V}$			0.6	V
Output Logic High (SDA)	V_{OH}	$R_{PULL-UP} = 2.2\text{ k}\Omega$ to $V_{DD} = 5\text{ V}, V_{SS} = 0\text{ V}$	4.9			V
Output Logic Low (SDA)	V_{OL}	$R_{PULL-UP} = 2.2\text{ k}\Omega$ to $V_{DD} = 5\text{ V}, V_{SS} = 0\text{ V}$			0.4	V
WP Leakage Current	I_{WP}	$WP = V_{DD}$			5	μA

AD5253/AD5254

Parameter	Symbol	Conditions	Min	Typ ¹	Max	Unit
DIGITAL INPUTS AND OUTPUTS (continued)						
A0 Leakage Current	I_{A0}	$A0 = GND$			3	μA
Input Leakage Current (Other than WP and A0)	I_I	$V_{IN} = 0 V \text{ or } V_{DD}$			± 1	μA
Input Capacitance ⁵	C_I			5		pF
POWER SUPPLIES						
Single-Supply Power Range	V_{DD}	$V_{SS} = 0 V$	2.7		5.5	V
Dual-Supply Power Range	V_{DD}/V_{SS}		± 2.25		± 2.75	V
Positive Supply Current	I_{DD}	$V_{IH} = V_{DD} \text{ or } V_{IL} = GND$		5	15	μA
Negative Supply Current	I_{SS}	$V_{IH} = V_{DD} \text{ or } V_{IL} = GND, V_{DD} = +2.5 V, V_{SS} = -2.5 V$		-5	-15	μA
EEMEM Data Storing Mode Current	I_{DD_STORE}	$V_{IH} = V_{DD} \text{ or } V_{IL} = GND$		35		mA
EEMEM Data Restoring Mode Current ⁶	$I_{DD_RESTORE}$	$V_{IH} = V_{DD} \text{ or } V_{IL} = GND$		2.5		mA
Power Dissipation ⁷	P_{DISS}	$V_{IH} = V_{DD} = 5 V \text{ or } V_{IL} = GND$			0.075	mW
Power Supply Sensitivity	PSS	$\Delta V_{DD} = 5 V \pm 10\%$ $\Delta V_{DD} = 3 V \pm 10\%$	-0.025 -0.04	0.01 0.02	0.025 0.04	%/% %/%
DYNAMIC CHARACTERISTICS ^{5,8}						
Bandwidth -3 dB	BW	$R_{AB} = 1 k\Omega$		4		MHz
Total Harmonic Distortion	THD	$V_A = 1 V \text{ rms}, V_B = 0 V, f = 1 \text{ kHz}$		0.05		%
V_W Settling Time	t_s	$V_A = V_{DD}, V_B = 0 V$		0.2		μs
Resistor Noise Voltage	e_{N_WB}	$R_{WB} = 500 \Omega, f = 1 \text{ kHz}$. Thermal noise only.		3		nV/\sqrt{Hz}
Digital Crosstalk	C_T	$V_A = V_{DD}, V_B = 0 V$, measure V_W with adjacent RDAC making full-scale change		-80		dB
Analog Coupling	C_{AT}	Signal input at A0 and measure the output at W1, $f = 1 \text{ kHz}$		-72		dB

10 k Ω , 50 k Ω , 100 k Ω VERSIONS

$V_{DD} = +3\text{ V} \pm 10\%$ or $+5\text{ V} \pm 10\%$, $V_{SS} = 0\text{ V}$ or $V_{DD}/V_{SS} = \pm 2.5\text{ V} \pm 10\%$, $V_A = +V_{DD}$, $V_B = 0\text{ V}$, $-40^\circ\text{C} < T_A < +85^\circ\text{C}$, unless otherwise noted.

Table 2.

Parameter	Symbol	Conditions	Min	Typ ¹	Max	Unit
DC CHARACTERISTICS—RHEOSTAT MODE						
Resolution	N	AD5253/AD5254			6/8	Bits
Resistor Differential Nonlinearity ²	R-DNL	$R_{WB}, R_{WA} = \text{NC}$, AD5253	-0.75	± 0.1	+0.75	LSB
		$R_{WB}, R_{WA} = \text{NC}$, AD5254	-1	± 0.25	+1	LSB
Resistor Nonlinearity ²	R-INL	$R_{WB}, R_{WA} = \text{NC}$, AD5253	-0.75	± 0.25	+0.75	LSB
		$R_{WB}, R_{WA} = \text{NC}$, AD5254	-2.5	± 1	+2.5	LSB
Nominal Resistor Tolerance	$\Delta R_{AB}/R_{AB}$	$T_A = 25^\circ\text{C}$	-20		+20	%
Resistance Temperature Coefficient	$(\Delta R_{AB}/R_{AB}) \times 10^6/\Delta T$			650		ppm/ $^\circ\text{C}$
Wiper Resistance	R_W	$I_W = 1\text{ V}/R$, $V_{DD} = 5\text{ V}$		75	130	Ω
		$I_W = 1\text{ V}/R$, $V_{DD} = 3\text{ V}$		200	300	Ω
Channel Resistance Matching	$\Delta R_{AB1}/\Delta R_{AB2}$	$R_{AB} = 10\text{ k}\Omega$, $50\text{ k}\Omega$		0.15		%
		$R_{AB} = 100\text{ k}\Omega$		0.05		%
DC CHARACTERISTICS—POTENTIOMETER DIVIDER MODE						
Differential Nonlinearity ³	DNL	AD5253	-0.5	± 0.1	+0.5	LSB
		AD5254	-1	± 0.3	+1	LSB
Integral Nonlinearity ³	INL	AD5253	-0.5	± 0.15	+0.5	LSB
		AD5254	-1.5	± 0.5	+1.5	LSB
Voltage Divider Temperature Coefficient	$(\Delta V_W/V_W) \times 10^6/\Delta T$	Code = Half scale		15		ppm/ $^\circ\text{C}$
Full-Scale Error	V_{WFSE}	Code = Full scale, AD5253	-1	-0.3	0	LSB
		Code = Full scale, AD5254	-3	-1	0	LSB
Zero-Scale Error	V_{WZSE}	Code = Zero scale, AD5253	0	0.3	1	LSB
		Code = Zero scale, AD5254	0	1.2	3	LSB
RESISTOR TERMINALS						
Voltage Range ⁴	V_A, V_B, V_W		V_{SS}		V_{DD}	V
Capacitance ⁵ Ax, Bx	C_A, C_B	$f = 1\text{ kHz}$, measured to GND, Code = Half scale		85		pF
Capacitance ⁵ Wx	C_W	$f = 1\text{ kHz}$, measured to GND, Code = Half scale		95		pF
Common-Mode Leakage Current ⁶	I_{CM}	$V_A = V_B = V_{DD}/2$		0.01	1	μA
DIGITAL INPUTS AND OUTPUTS						
Input Logic High	V_{IH}	$V_{DD} = 5\text{ V}$, $V_{SS} = 0\text{ V}$	2.4			V
		$V_{DD}/V_{SS} = +2.7\text{ V}/0\text{ V}$ or $V_{DD}/V_{SS} = \pm 2.5\text{ V}$	2.1			V
Input Logic Low	V_{IL}	$V_{DD} = 5\text{ V}$, $V_{SS} = 0\text{ V}$			0.8	V
		$V_{DD}/V_{SS} = +2.7\text{ V}/0\text{ V}$ or $V_{DD}/V_{SS} = \pm 2.5\text{ V}$			0.6	V
Output Logic High (SDA)	V_{OH}	$R_{PULL-UP} = 2.2\text{ k}\Omega$ to $V_{DD} = 5\text{ V}$, $V_{SS} = 0\text{ V}$	4.9			V
Output Logic Low (SDA)	V_{OL}	$R_{PULL-UP} = 2.2\text{ k}\Omega$ to $V_{DD} = 5\text{ V}$, $V_{SS} = 0\text{ V}$			0.4	V
WP Leakage Current	I_{WP}	WP = V_{DD}			5	μA
A0 Leakage Current	I_{A0}	A0 = GND			3	μA
Input Leakage Current (Other than WP and A0)	I_I	$V_{IN} = 0\text{ V}$ or V_{DD}			± 1	μA
Input Capacitance ⁵	C_I			5		pF
POWER SUPPLIES						
Single-Supply Power Range	V_{DD}	$V_{SS} = 0\text{ V}$	2.7		5.5	V
Dual-Supply Power Range	V_{DD}/V_{SS}		± 2.25		± 2.75	V
Positive Supply Current	I_{DD}	$V_{IH} = V_{DD}$ or $V_{IL} = \text{GND}$		5	15	μA

AD5253/AD5254

Parameter	Symbol	Conditions	Min	Typ ¹	Max	Unit
POWER SUPPLIES (continued)						
Negative Supply Current	I _{SS}	V _{IH} = V _{DD} or V _{IL} = GND, V _{DD} = +2.5 V, V _{SS} = -2.5 V		-5	-15	μA
EEMEM Data Storing Mode Current	I _{DD_STORE}	V _{IH} = V _{DD} or V _{IL} = GND, T _A = 0°C to 85°C		35		mA
EEMEM Data Restoring Mode Current ⁶	I _{DD_RESTORE}	V _{IH} = V _{DD} or V _{IL} = GND, T _A = 0°C to 85°C		2.5		mA
Power Dissipation ⁷	P _{DISS}	V _{IH} = V _{DD} = 5 V or V _{IL} = GND			0.075	mW
Power Supply Sensitivity	PSS	ΔV _{DD} = 5 V ± 10%	-0.005	+0.002	+0.005	%/%
		ΔV _{DD} = 3 V ± 10%	-0.01	+0.002	+0.01	%/%
DYNAMIC CHARACTERISTICS ^{5,8}						
-3 dB Bandwidth	BW	R _{AB} = 10 kΩ/50 kΩ/100 kΩ		400/80/40		kHz
Total Harmonic Distortion	THDW	V _A = 1 V _{rms} , V _B = 0 V, f = 1 kHz		0.05		%
V _w Settling Time	t _s	V _A = V _{DD} , V _B = 0 V, R _{AB} = 10 kΩ/50 kΩ/100 kΩ		1.5/7/14		μs
Resistor Noise Voltage	e _{N_WB}	R _{AB} = 10 kΩ/50 kΩ/100 kΩ, Code = Midscale, f = 1 kHz. Thermal noise only.		9/20/29		nV/√Hz
Digital Crosstalk	C _T	V _A = V _{DD} , V _B = 0 V, Measure V _w with adjacent RDAC making full scale change		-80		dB
Analog Coupling	C _{AT}	Signal input at A0 and measure output at W1, f = 1 kHz		-72		dB

INTERFACE TIMING CHARACTERISTICS (ALL PARTS)

Guaranteed by design, not subject to production test. See Figure 23 for location of measured values. All input control voltages are specified with $t_R = t_F = 2.5$ ns (10% to 90% of 3 V) and timed from a voltage level of 1.5 V. Switching characteristics are measured using both $V_{DD} = 3$ V and 5 V. When the part is not in operation, the SDA and SCL pins should be pulled high. When these pins are pulled low, the I²C interface at these pins conducts current of about 0.8 mA at $V_{DD} = 5.5$ V and 0.2 mA at $V_{DD} = 2.7$ V.

Table 3.

Parameter	Symbol	Conditions	Min	Typ ¹	Max	Unit
SCL Clock Frequency	f_{SCL}				400	kHz
t_{BUF} Bus Free Time between STOP and START	t_1	After this period, the first clock pulse is generated	1.3			μ s
$t_{HD,STA}$ Hold Time (Repeated START)	t_2		0.6			μ s
t_{LOW} Low Period of SCL Clock	t_3		1.3			μ s
t_{HIGH} High Period of SCL Clock	t_4		0.6			μ s
$t_{SU,STA}$ Setup Time for START Condition	t_5		0.6			μ s
$t_{HD,DAT}$ Data Hold Time	t_6		0		0.9	μ s
$t_{SU,DAT}$ Data Setup Time	t_7		100			ns
t_F Fall Time of Both SDA and SCL Signals	t_8				300	ns
t_R Rise Time of Both SDA and SCL Signals	t_9				300	ns
$t_{SU,STO}$ Setup Time for STOP Condition	t_{10}		0.6			μ s
EEMEM Data Storing Time	t_{EEMEM_STORE}			26	ms	
EEMEM Data Restoring Time at Power On ⁹	$t_{EEMEM_RESTORE1}$	V_{DD} rise time dependent. Measure without decoupling capacitors at V_{DD} and V_{SS} .		300	μ s	
EEMEM Data Restoring Time upon Restore Command or RESET Operation ⁹	$t_{EEMEM_RESTORE2}$	$V_{DD} = 5$ V		300	μ s	
EEMEM Data Rewritable Time ¹⁰	$t_{EEMEM_REWRITE}$			540	μ s	
FLASH/EE MEMORY RELIABILITY						
Endurance ¹¹			100			kCycles
Data Retention ¹²				100		Years

¹ Typical values represent average readings at 25°C and $V_{DD} = 5$ V.

² Resistor position nonlinearity error (R-INL) is the deviation from an ideal value measured between the maximum resistance and the minimum resistance wiper positions. R-DNL measures the relative step change from ideal between successive tap positions. Parts are guaranteed monotonic, except R-DNL of AD5254 1 k Ω version at $V_{DD} = 2.7$ V, $I_W = V_{DD}/R$ for both $V_{DD} = 3$ V or $V_{DD} = 5$ V.

³ INL and DNL are measured at V_W with the RDAC configured as a potentiometer divider similar to a voltage output D/A converter. $V_A = V_{DD}$ and $V_B = 0$ V. DNL specification limits of ± 1 LSB maximum are guaranteed monotonic operating conditions.

⁴ Resistor terminals A, B, and W have no limitations on polarity with respect to each other.

⁵ Guaranteed by design and not subject to production test.

⁶ cmd 0 NOP should be activated after cmd 1 in order to minimize $I_{DD_RESTORE}$ current consumption.

⁷ P_{DISS} is calculated from $(I_{DD} \times V_{DD} = 5$ V).

⁸ All dynamic characteristics use $V_{DD} = 5$ V.

⁹ During power-up, all outputs preset to midscale before restoring EEMEM contents. RDAC0 has the shortest whereas RDAC3 has the longest EEMEM restore time.

¹⁰ Delay time after power-on or RESET before new EEMEM data to be written.

¹¹ Endurance is qualified to 100,000 cycles per JEDEC Std. 22 method A117, and is measured at -40°C, +25°C, and +85°C; typical endurance at +25°C is 700,000 cycles.

¹² Retention lifetime equivalent at junction temperature (T_J) = 55°C per JEDEC Std. 22, Method A117. Retention lifetime based on an activation energy of 0.6eV derates with junction temperature.

AD5253/AD5254

ABSOLUTE MAXIMUM RATINGS

Table 4. $T_A = 25^\circ\text{C}$, unless otherwise noted

Parameter	Rating
V_{DD} to GND	-0.3 V, +7 V
V_{SS} to GND	+0.3 V, -7 V
V_{DD} to V_{SS}	7 V
V_A, V_B, V_W to GND	V_{SS}, V_{DD}
Maximum Current	
I_{WB}, I_{WA} Pulsed	± 20 mA
I_{WB} Continuous ($R_{WB} \leq 1$ k Ω , A Open) ¹	± 5 mA
I_{WA} Continuous ($R_{WA} \leq 1$ k Ω , B Open) ¹	± 5 mA
I_{AB} Continuous ($R_{AB} = 1$ k $\Omega/10$ k $\Omega/50$ k $\Omega/100$ k Ω) ¹	± 5 mA/ ± 500 μ A/ ± 100 μ A/ ± 50 μ A
Digital Inputs and Output Voltage to GND	0 V, 7 V
Operating Temperature Range	-40°C to +85°C
Maximum Junction Temperature ($T_{J\text{MAX}}$)	150°C
Storage Temperature	-65°C to +150°C
Lead Temperature (Soldering, 10 sec)	300°C
Vapor Phase (60 sec)	215°C
Infrared (15 sec)	220°C
TSSOP-20 Thermal Resistance ² θ_{JA}	143°C/W

Stresses above those listed under Absolute Maximum Ratings may cause permanent damage to the device. This is a stress rating only; functional operation of the device at these or any other conditions above those listed in the operational sections of this specification is not implied. Exposure to absolute maximum rating conditions for extended periods may affect device reliability.

¹ Maximum terminal current is bounded by the maximum applied voltage across any two of the A, B, and W terminals at a given resistance, the maximum current handling of the switches, and the maximum power dissipation of the package. $V_{DD} = 5$ V.

² Package power dissipation = $(T_{J\text{MAX}} - T_A)/\theta_{JA}$.

ESD CAUTION

ESD (electrostatic discharge) sensitive device. Electrostatic charges as high as 4000 V readily accumulate on the human body and test equipment and can discharge without detection. Although this product features proprietary ESD protection circuitry, permanent damage may occur on devices subjected to high energy electrostatic discharges. Therefore, proper ESD precautions are recommended to avoid performance degradation or loss of functionality.



PIN CONFIGURATION AND FUNCTIONAL DESCRIPTIONS

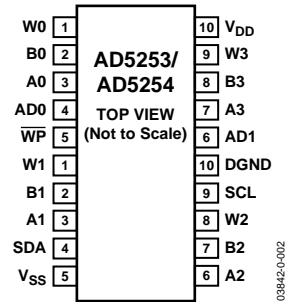

Figure 2. AD5253/AD5254 Pin Configuration

Table 5. AD5253/AD5254 Pin Function Descriptions

Pin No.	Mnemonic	Description
1	W0	Wiper Terminal of RDAC0. $V_{SS} \leq V_{W0} \leq V_{DD}$.
2	B0	B Terminal of RDAC0. $V_{SS} \leq V_{B0} \leq V_{DD}$.
3	A0	A Terminal of RDAC0. $V_{SS} \leq V_{A0} \leq V_{DD}$.
4	AD0	I ² C Device Address 0. AD0 and AD1 allow four AD5253/AD5254s to be addressed.
5	\overline{WP}	Write Protect, Active Low. $V_{WP} \leq V_{DD} + 0.3$ V.
6	W1	Wiper Terminal of RDAC1. $V_{SS} \leq V_{W1} \leq V_{DD}$.
7	B1	B Terminal of RDAC1. $V_{SS} \leq V_{B1} \leq V_{DD}$.
8	A1	A Terminal of RDAC1. $V_{SS} \leq V_{A1} \leq V_{DD}$.
9	SDA	Serial Data Input/Output Pin. Shifts in one bit at a time on positive clock CLK edges. MSB loaded first. Open-drain MOSFET requires pull-up resistor.
10	V _{SS}	Negative Supply. Connect to 0 V for single supply or -2.7 V for dual supply, where $V_{DD} - V_{SS} \leq +5.5$ V. If V _{SS} is used, rather than grounded, in dual supply, V _{SS} must be able to sink 35 mA for 26 ms when storing data to EEMEM.
11	A2	A Terminal of RDAC2. $V_{SS} \leq V_{A2} \leq V_{DD}$.
12	B2	B Terminal of RDAC2. $V_{SS} \leq V_{B2} \leq V_{DD}$.
13	W2	Wiper Terminal of RDAC2. $V_{SS} \leq V_{W2} \leq V_{DD}$.
14	SCL	Serial Input Register Clock Pin. Shifts in one bit at a time on positive clock edges. $V_{SCL} \leq (V_{DD} + 0.3)$ V. Pull-up resistor is recommended for SCL to ensure minimum power.
15	DGND	Digital Ground. Connect to system analog ground at a single point.
16	AD1	I ² C Device Address 1. AD0 and AD1 allow four AD5253/AD5254s to be addressed.
17	A3	A Terminal of RDAC3. $V_{SS} \leq V_{A3} \leq V_{DD}$.
18	B3	B Terminal of RDAC3. $V_{SS} \leq V_{B3} \leq V_{DD}$.
19	W3	W Terminal of RDAC3. $V_{SS} \leq V_{W3} \leq V_{DD}$.
20	V _{DD}	Positive Power Supply Pin. Connect $+2.7$ V to $+5$ V for single supply or ± 2.7 V for dual supply, where $V_{DD} - V_{SS} \leq 5.5$ V. V _{DD} must be able to source 35 mA for 26 ms when storing data to EEMEM.

TYPICAL PERFORMANCE CHARACTERISTICS

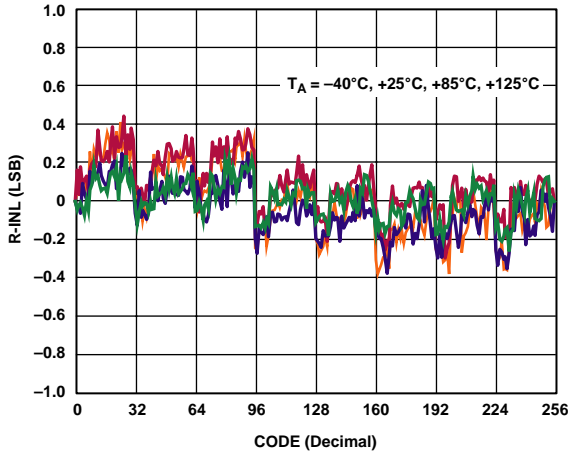

Figure 3. R-INL vs. Code

03824-0-015

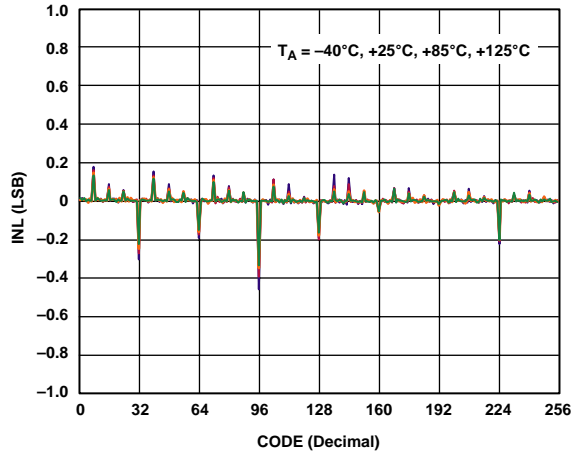

Figure 6. DNL vs. Code

03824-0-018

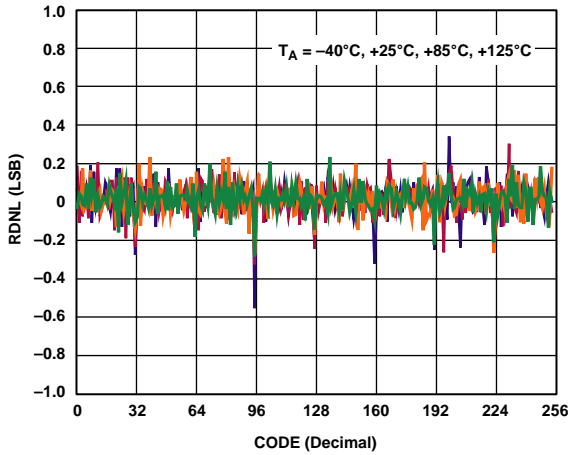

Figure 4. R-DNL vs. Code

03824-0-016

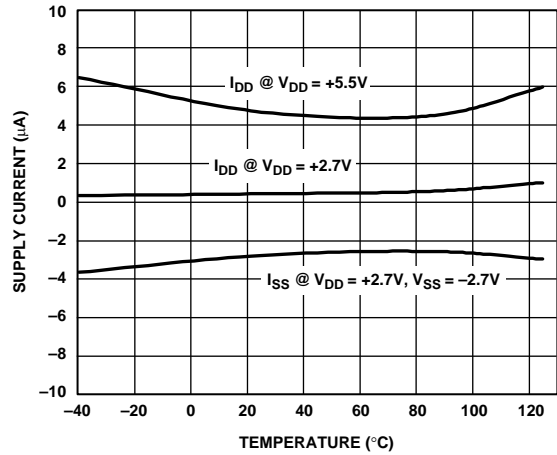

Figure 7. Supply Current vs. Temperature

03824-0-019

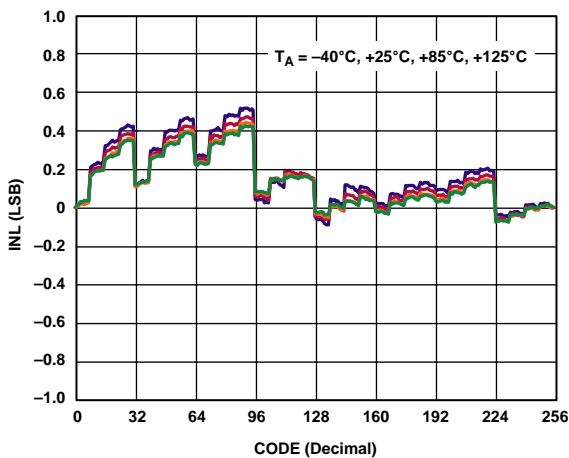

Figure 5. INL vs. Code

03824-0-017

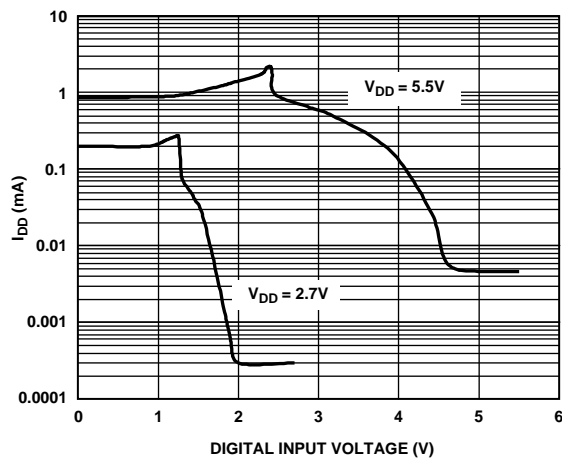

Figure 8. Supply Current vs. Digital Input Voltage. TA = 25°C

03824-0-020

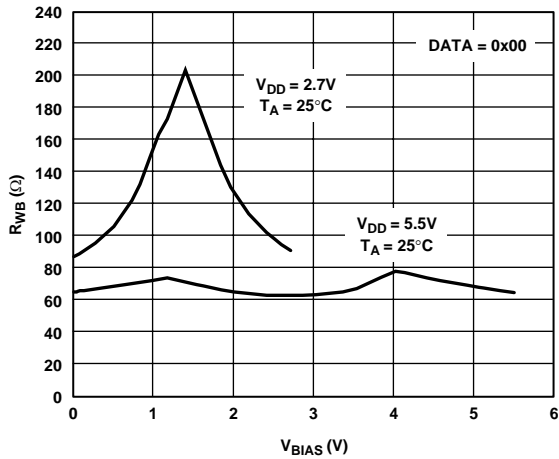

Figure 9. Wiper Resistance vs. V_{BIAS}

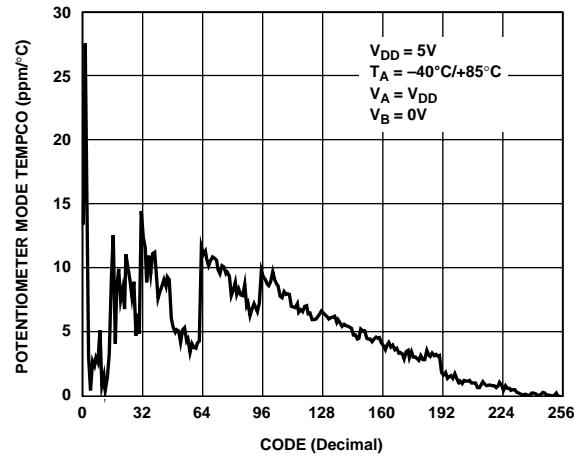

Figure 12. Potentiometer Mode Tempco ($\Delta V_{WB}/V_{WB}$)/ $\Delta T \times 10^6$ vs. Code

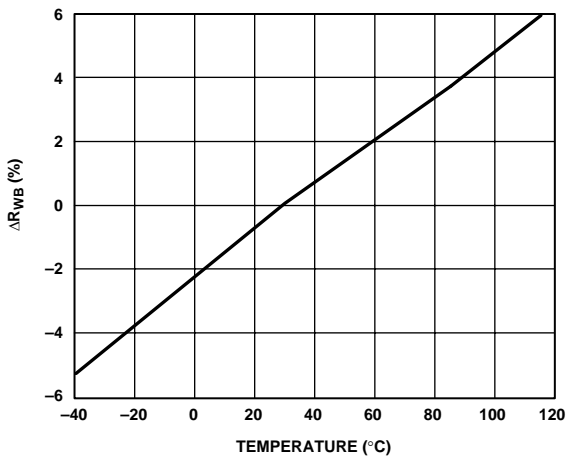

Figure 10. Change of R_{AB} vs. Temperature

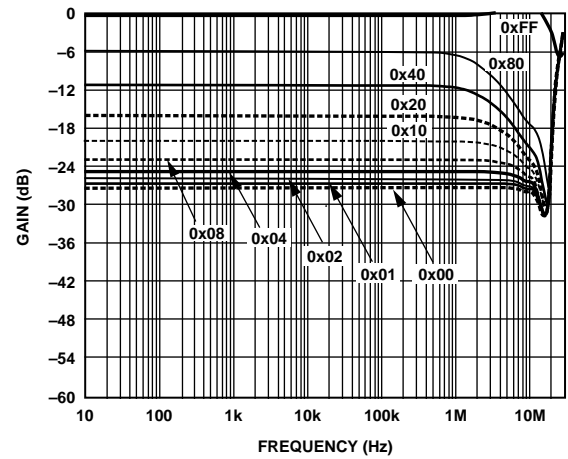

Figure 13. Gain vs. Frequency vs. Code, $R_{AB} = 1 \text{ k}\Omega$, $T_A = 25^\circ\text{C}$

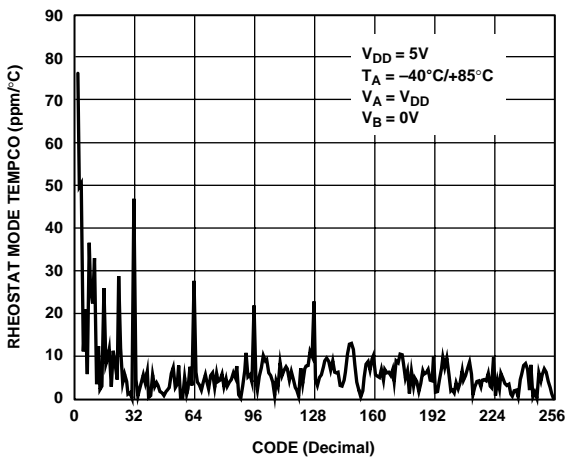

Figure 11. Rheostat Mode Tempco ($\Delta R_{WB}/R_{WB}$)/ $\Delta T \times 10^6$ vs. Code

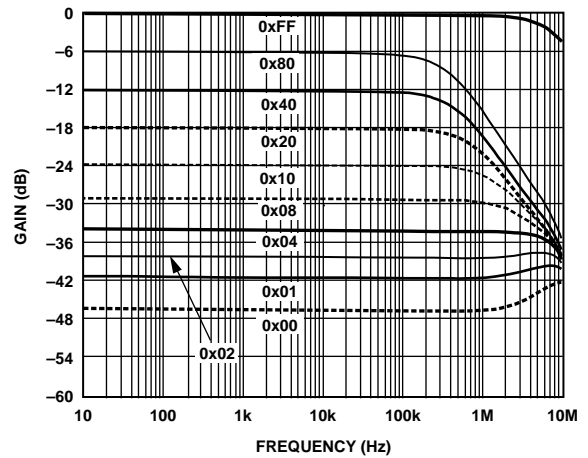

Figure 14. Gain vs. Frequency vs. Code, $R_{AB} = 10 \text{ k}\Omega$, $T_A = 25^\circ\text{C}$

AD5253/AD5254

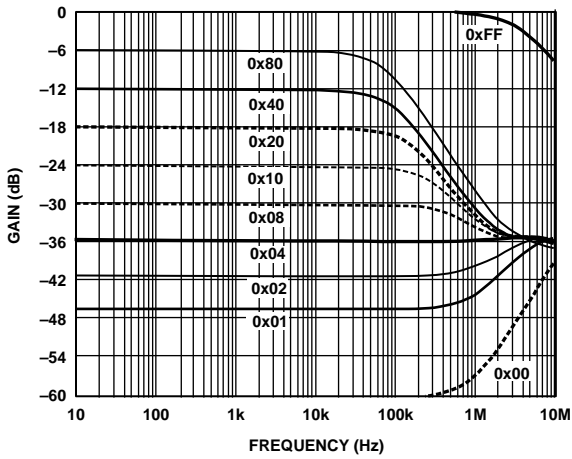

Figure 15. Gain vs. Frequency vs. Code, $R_{AB} = 50\text{ k}\Omega$, $T_A = 25^\circ\text{C}$

03824-0-027

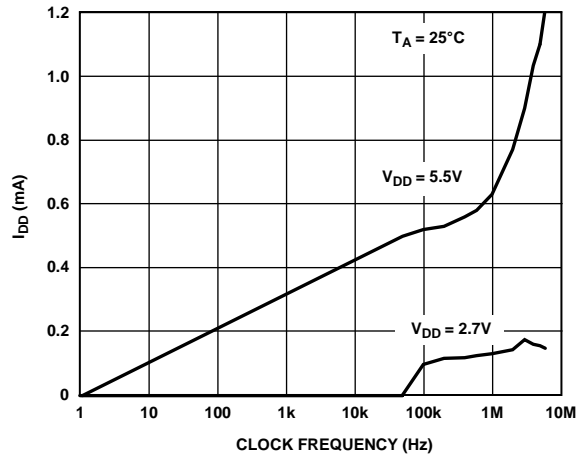

Figure 18. Supply Current vs. Digital Input Clock Frequency

03824-0-030

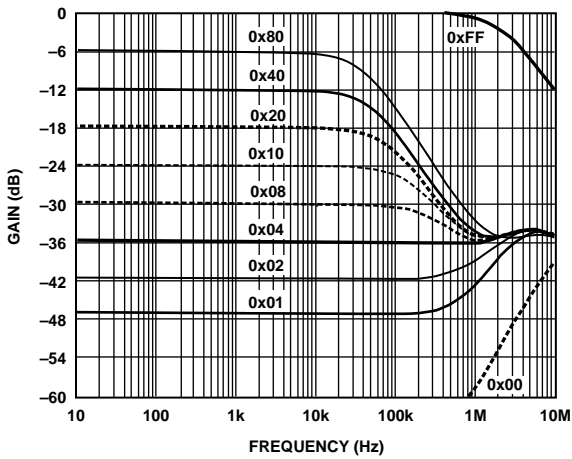

Figure 16. Gain vs. Frequency vs. Code, $R_{AB} = 100\text{ k}\Omega$, $T_A = 25^\circ\text{C}$

03824-0-028

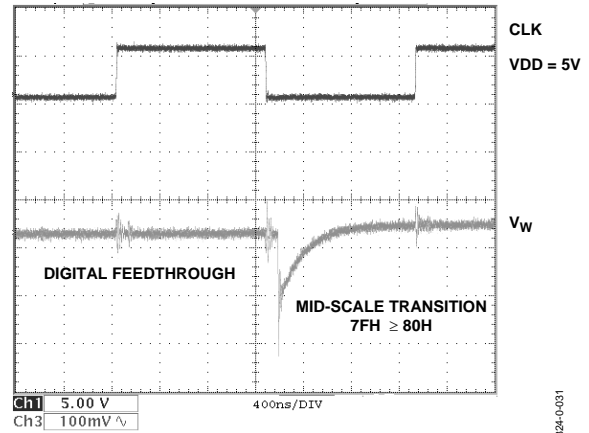

Figure 19. Clock Feedthrough and Midscale Transition Glitch

03824-0-031

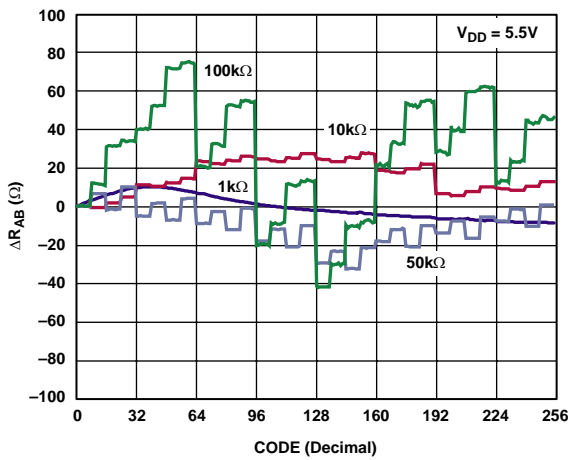

Figure 17. ΔR_{AB} vs. Code, $T_A = 25^\circ\text{C}$

03824-0-029

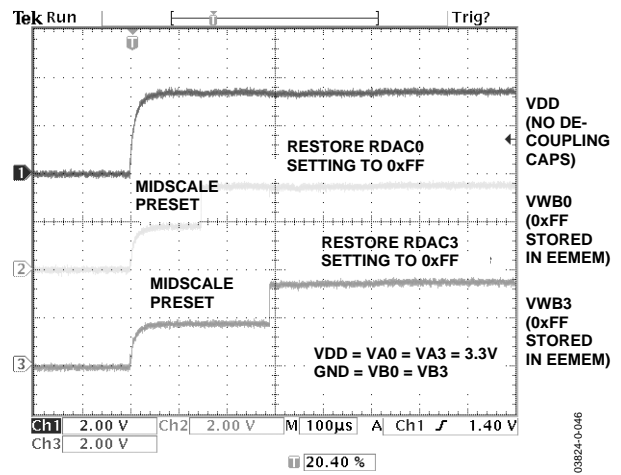

Figure 20. $teMEM_RESTORE$ of RDAC0 and RDAC3

03824-0-046

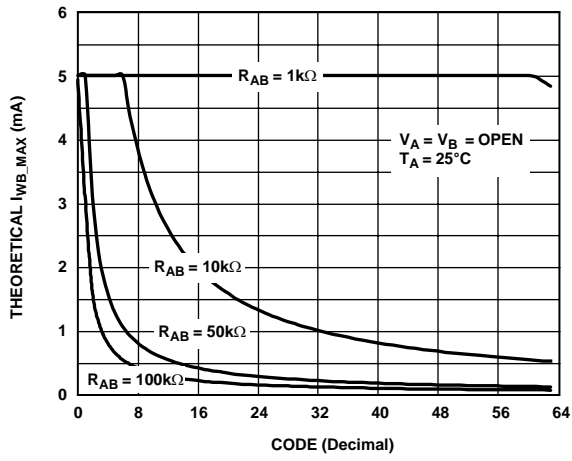

Figure 21. I_{WB_MAX} vs. Code (AD5253)

03824-0-033

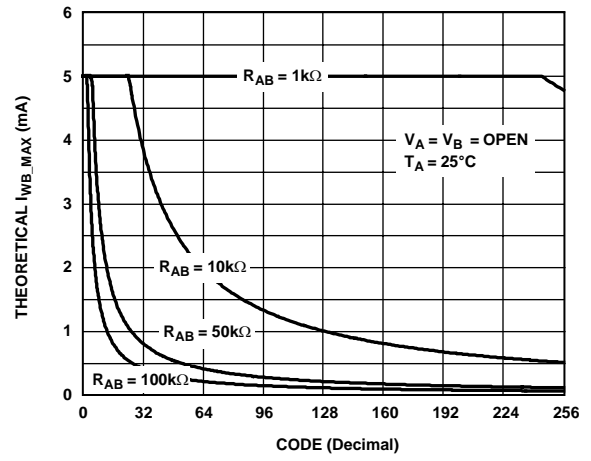

Figure 22. I_{WB_MAX} vs. Code (AD5254)

03824-0-034

I²C INTERFACE

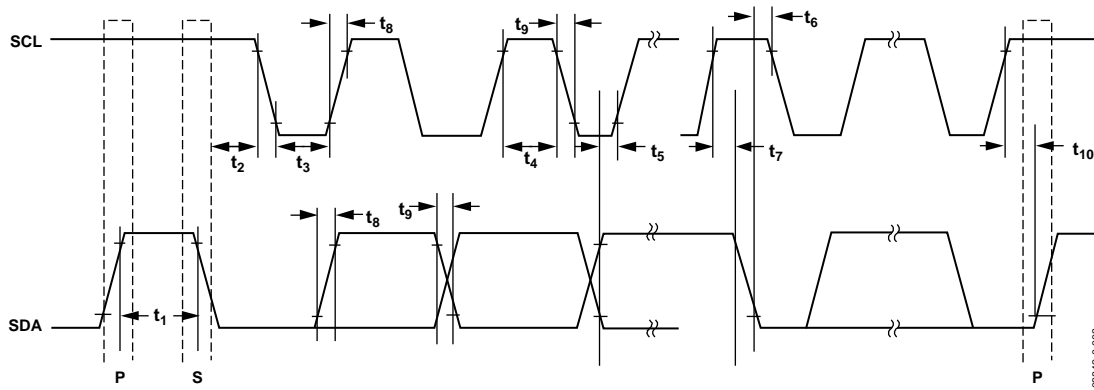
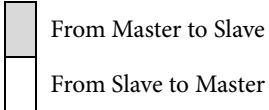

Figure 23. I²C Interface Timing Diagram

I²C INTERFACE GENERAL DESCRIPTION



S = Start Condition.

P = Stop Condition.

A = Acknowledge (SDA Low).

\bar{A} = Not Acknowledge (SDA High).

R/ \bar{W} = Read Enable at High; Write Enable at Low.

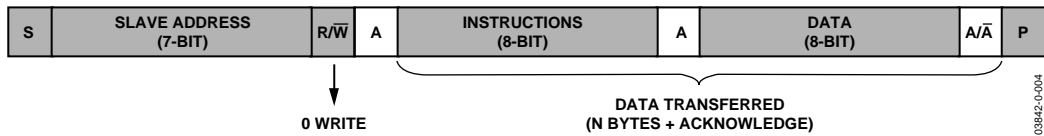

Figure 24. I²C—Master Writing Data to Slave

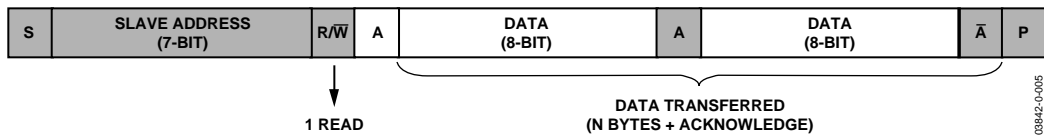

Figure 25. I²C—Master Reading Data From Slave

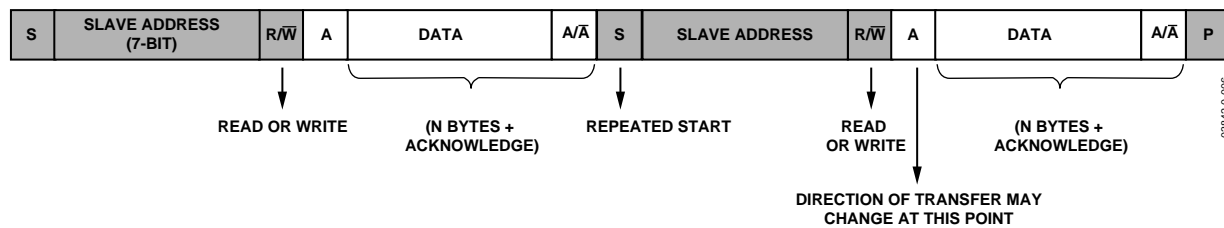

Figure 26. I²C—Combined Write/Read

I²C INTERFACE DETAIL DESCRIPTION

- From Master to Slave
- From Slave to Master

S = Start Condition.

P = Stop Condition.

A = Acknowledge (SDA Low).

\bar{A} = Not Acknowledge (SDA High).

AD1, AD0 = I²C Device Address Bits. Must match with the logic states at Pins AD1, AD0.

R/ \bar{W} = Read Enable Bit, Logic High/Write Enable Bit, Logic Low.

CMD/ \bar{REG} = Command Enable Bit, Logic High/Register Access Bit, Logic Low.

EE/ \bar{RDAC} = EEMEM Register, Logic High/RDAC Register, Logic Low.

A4, A3, A2, A1, A0 = RDAC/EEMEM Register Addresses.

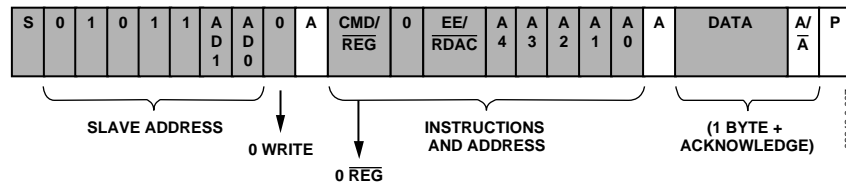

Figure 27. Single Write Mode

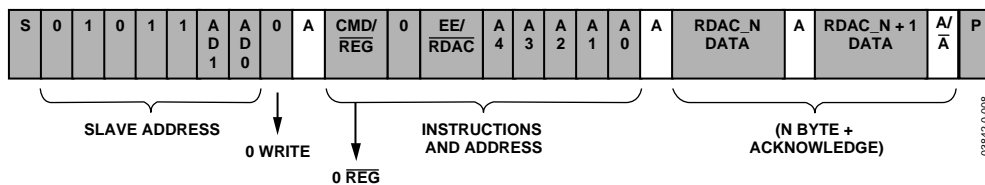

Figure 28. Consecutive Write Mode

Table 6. Addresses for Writing Data Byte Contents to RDAC Registers (R/ \bar{W} = 0, CMD/ \bar{REG} = 0, EE/ \bar{RDAC} = 0)

A4	A3	A2	A1	A0	RDAC	Data Byte Description
0	0	0	0	0	RDAC0	6-/8-bit wiper setting (2 MSBs of AD5253 are X)
0	0	0	0	1	RDAC1	6-/8-bit wiper setting (2 MSBs of AD5253 are X)
0	0	0	1	0	RDAC2	6-/8-bit wiper setting (2 MSBs of AD5253 are X)
0	0	0	1	1	RDAC3	6-/8-bit wiper setting (2 MSBs of AD5253 are X)
0	0	1	0	0	Reserved	
:	:	:	:	:		
0	1	1	1	1	Reserved	

AD5253/AD5254

RDAC/EEMEM Write

Setting the wiper position requires an RDAC write operation. The single write operation is shown in Figure 27, and the consecutive write operation is shown in Figure 28. In consecutive write operation, if the RDAC is selected and the address starts at 0, the first data byte goes to RDAC0, the second data byte goes to RDAC1, the third data byte goes to RDAC2, and the fourth data byte goes to RDAC3. This operation can be continued up to eight addresses with four unused addresses; it then loops back to RDAC0. If the address starts at any of the eight valid addresses, N, the data first goes to RDAC_N, RDAC_N + 1, and so on; it loops back to RDAC0 after the eighth address. The RDAC address is shown in Table 6.

While the RDAC wiper setting is controlled by a specific RDAC register, each RDAC register corresponds to a specific EEMEM memory location, which provides nonvolatile wiper storage functionality. The addresses are shown in Table 7. The single and consecutive write operations also apply to EEMEM write operations.

There are 12 nonvolatile memory locations, EEMEM4 to EEMEM15, where users can store 12 bytes of information such as memory data for other components, look-up table, or system identification information.

In a write operation to the EEMEM registers, the device disables the I²C interface during the internal write cycle. Acknowledge polling, which is discussed later in the data sheet, is required to determine the completion of the write cycle.

RDAC/EEMEM Read

The AD5253/AD5254 provide two different RDAC or EEMEM read operations. For example, Figure 29 shows the method of reading the RDAC0 to RDAC3 contents without specifying the address, assuming address RDAC0 was already selected from the previous operation. If RDAC_N, other than address 0, is selected previously, readback starts with address N, followed by N + 1, and so on.

Figure 30 illustrates the random RDAC or EEMEM read operation. This operation allows users to specify which RDAC or EEMEM register is read by first issuing a dummy write command to change the RDAC address pointer, and then proceeding with the RDAC read operation at the new address location.

Table 7. Addresses for Writing (Storing) RDAC Settings and User-Defined Data to EEMEM Registers (R/W = 0, CMD/REG = 0, EE/RDAC = 1)

A4	A3	A2	A1	A0	Data Byte Description
0	0	0	0	0	Store RDAC0 Setting to EEMEM0 ¹
0	0	0	0	1	Store RDAC1 Setting to EEMEM1 ¹
0	0	0	1	0	Store RDAC2 Setting to EEMEM2 ¹
0	0	0	1	1	Store RDAC3 Setting to EEMEM3 ¹
0	0	1	0	0	Store User Data to EEMEM4
0	0	1	0	1	Store User Data to EEMEM5
0	0	1	1	0	Store User Data to EEMEM6
0	0	1	1	1	Store User Data to EEMEM7
0	1	0	0	0	Store User Data to EEMEM8
0	1	0	0	1	Store User Data to EEMEM9
0	1	0	1	0	Store User Data to EEMEM10
0	1	0	1	1	Store User Data to EEMEM11
0	1	1	0	0	Store User Data to EEMEM12
0	1	1	0	1	Store User Data to EEMEM13
0	1	1	1	0	Store User Data to EEMEM14
0	1	1	1	1	Store User Data to EEMEM15

Table 8. Addresses for Reading (Restoring) RDAC Settings and User Data from EEMEM (R/W = 1, CMD/REG = 0, EE/RDAC = 1)

A4	A3	A2	A1	A0	Data Byte Description
0	0	0	0	0	Read RDAC0 setting from EEMEM0
0	0	0	0	1	Read RDAC1 setting from EEMEM1
0	0	0	1	0	Read RDAC2 setting from EEMEM2
0	0	0	1	1	Read RDAC3 setting from EEMEM3
0	0	1	0	0	Read User Data from EEMEM4
0	0	1	0	1	Read User Data from EEMEM5
0	0	1	1	0	Read User Data from EEMEM6
0	0	1	1	1	Read User Data from EEMEM7
0	1	0	0	0	Read User Data from EEMEM8
0	1	0	0	1	Read User Data from EEMEM9
0	1	0	1	0	Read User Data from EEMEM10
0	1	0	1	1	Read User Data from EEMEM11
0	1	1	0	0	Read User Data from EEMEM12
0	1	1	0	1	Read User Data from EEMEM13
0	1	1	1	0	Read User Data from EEMEM14
0	1	1	1	1	Read User Data from EEMEM15

¹ User can store any 64 RDAC settings for AD5253 or 256 RDAC settings for AD5254, not limited to current RDAC wiper setting, directly to EEMEM.

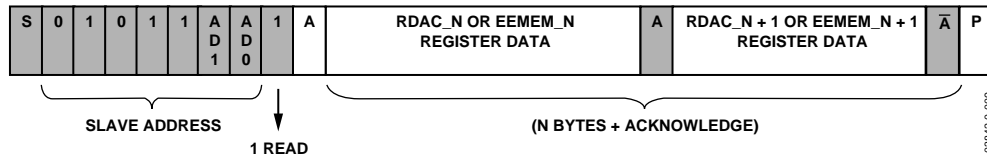

Figure 29. RDAC Current Read. Restricted to Previously Selected Address Stored in the Register.

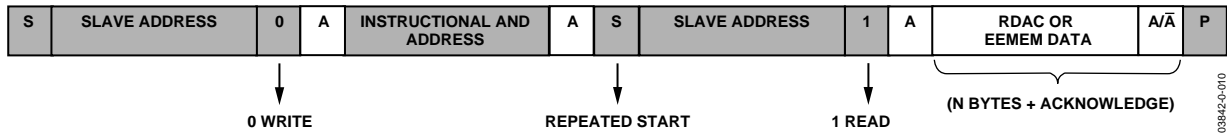

Figure 30. RDAC or EEMEM Random Read

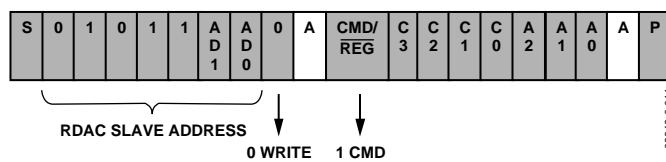
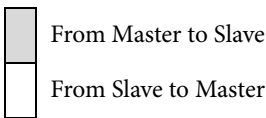

Figure 31. RDAC Quick Command Write (Dummy Write)



S = Start Condition

P = Stop Condition

A = Acknowledge (SDA Low)

A̅ = Not Acknowledge (SDA High)

AD1, AD0 = I²C Device Address Bits. Must match with the logic states at Pins AD1, AD0.

R/W̅ = Read Enable Bit, Logic High/Write Enable Bit, Logic Low

CMD/REG̅ = Command Enable Bit, Logic High/Register Access Bit, Logic Low

C3, C2, C1, C0 = Command Bits

A2, A1, A0 = RDAC/EEMEM Register Addresses

Table 9. RDAC-to-EEMEM Interface and RDAC Operation Quick Command Bits (CMD/REG = 1, A2 = 0)

C3	C2	C1	C0	Command Description
0	0	0	0	NOP
0	0	0	1	Restore EEMEM (A1, A0) to RDAC (A1, A0) ¹
0	0	1	0	Store RDAC (A1, A0) to EEMEM (A1, A0)
0	0	1	1	Decrement RDAC (A1, A0) 6 dB
0	1	0	0	Decrement All RDACs 6 dB
0	1	0	1	Decrement RDAC (A1, A0) One Step
0	1	1	0	Decrement All RDACs One Step
0	1	1	1	Reset: Restore EEMEMs to All RDACs
1	0	0	0	Increment RDACs (A1, A0) 6 dB
1	0	0	1	Increment All RDACs 6 dB
1	0	1	0	Increment RDACs (A1, A0) One Step
1	0	1	1	Increment All RDACs One Step
1	1	0	0	Reserved
:	:	:	:	
1	1	1	1	Reserved

RDAC/EEMEM Quick Commands

AD5253/AD5254 feature 12 quick commands that facilitate easy manipulation of RDAC wiper settings as well as provide RDAC-to-EEMEM storing and restoring functions. The command format is shown in Figure 31, and the command descriptions are shown in Table 9.

When using a quick command, issuing a third byte is not needed but is allowed. The quick commands Reset and Store RDAC to EEMEM require acknowledge polling to determine whether the command has finished executing.

¹ This command leaves the device in the EEMEM read power state, which consumes power. Issue the NOP command to return the device to the idle state.

AD5253/AD5254

Table 10. Address Table for Reading Tolerance (CMD/REG = 0, EE/RDAC = 1, A4 = 1)

A4	A3	A2	A1	A0	Data Byte Description
1	1	0	0	0	Sign and 7-Bit Integer Values of RDAC0 Tolerance (Read Only)
1	1	0	0	1	8-Bit Decimal Value of RDAC0 Tolerance (Read Only)
1	1	0	1	0	Sign and 7-Bit Integer Values of RDAC1 Tolerance (Read Only)
1	1	0	1	1	8-Bit Decimal Value of RDAC1 Tolerance (Read Only)
1	1	1	0	0	Sign and 7-Bit Integer Values of RDAC2 Tolerance (Read Only)
1	1	1	0	1	8-Bit Decimal Value of RDAC2 Tolerance (Read Only)
1	1	1	1	0	Sign and 7-Bit Integer Values of RDAC3 Tolerance (Read Only)
1	1	1	1	1	8-Bit Decimal Value of RDAC3 Tolerance (Read Only)

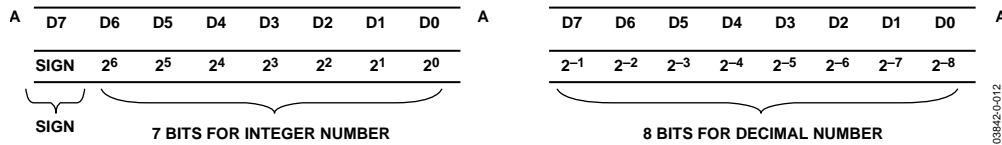

Figure 32. Format of Stored Tolerance in Sign Magnitude Format with Bit Position Descriptions. Unit is %. Only Data Bytes Are Shown.

R_{AB} Tolerance Stored in Read-Only Memory

AD5253/AD5254 feature patented R_{AB} tolerances storage in the nonvolatile memory. The tolerance of each channel is stored in the memory during the factory production and can be read by users at any time. The knowledge of the stored tolerance, which is the average of R_{AB} overall codes (Figure 29), allows users to predict R_{AB} accurately. This feature is valuable for precision, rheostat mode, or open-loop applications where knowledge of absolute resistance is critical.

The stored tolerances reside in the read-only memory, and are expressed in percent. The tolerance is coded in sign magnitude binary, 16 bits long, and is stored in two memory locations (see Table 10). The data format of the tolerance is the sign magnitude binary format; an example is shown in Figure 32. In the first memory location of the eight data bits, the MSB is designated for the sign (0 = + and 1 = -) and the 7 LSBs are designated for the integer portion of the tolerance. In the second memory location, all eight data bits are designated for the decimal portion of tolerance. As shown in Table 8 and Figure 32, for example, if the rated R_{AB} = 10 kΩ and the data readback from address 11000 shows 0001 1100 and address 11001 shows 0000 1111, then RDAC0 tolerance can be calculated as:

$$\begin{aligned}
 \text{MSB: } 0 &= + \\
 \text{Next 7 MSB: } 001\ 1100 &= 28 \\
 \text{8 LSB: } 0000\ 1111 &= 15 \times 2^{-8} = 0.06 \\
 \text{Tolerance} &= +28.06\% \text{ and therefore} \\
 R_{AB_ACTUAL} &= 12.806\ \text{k}\Omega
 \end{aligned}$$

EEMEM Write-Acknowledge Polling

After each write operation to the EEMEM registers, an internal write cycle begins. The I²C interface of the device is disabled. In order to determine if the internal write cycle is complete and the I²C interface is enabled, interface polling can be executed. I²C interface polling can be conducted by sending a start condition followed by the slave address + the write bit. If the I²C interface responds with an ACK, the write cycle is complete and the interface is ready to proceed with further operations. Otherwise, I²C interface polling can be repeated until it succeeds. Commands 2 and 7 also require acknowledge polling.

EEMEM Write Protection

Setting the $\overline{\text{WP}}$ pin to a logic LOW after EEMEM programming protects the memory and RDAC registers from future write operations. In this mode, the EEMEM and RDAC read operations operate as normal. When write protection is enabled, commands 1 (restore from EEMEM to RDAC) and 7 (reset) function normally to allow RDAC settings to be refreshed from the EEMEM to the RDAC registers.

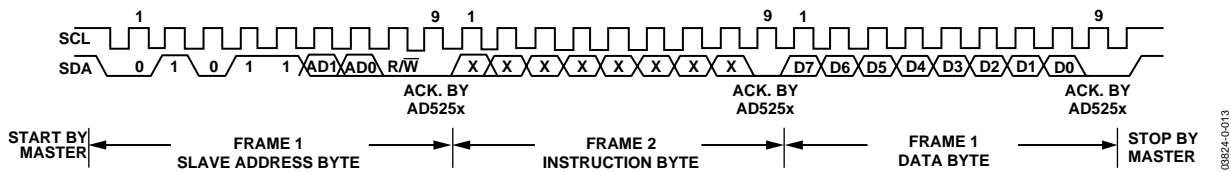
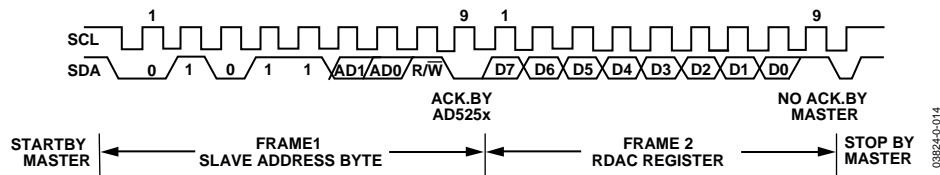
I²C COMPATIBLE 2-WIRE SERIAL BUSFigure 33. General I²C Write PatternFigure 34. General I²C Read Pattern

The first byte of the AD5253/AD5254 is a slave address byte (see Figure 24 and Figure 25). It has a 7-bit slave address and an R/W bit. The 5 MSB of the slave address are 01011, and the following 2 LSB are determined by the states of the AD1 and AD0 pins. AD1 and AD0 allow the user to place up to four AD5253/AD5254s on one bus. The 2-wire I²C serial bus protocol operates as follows:

AD5253/AD5254 can be controlled via an I²C compatible serial bus, and are connected to this bus as slave device. The 2-wire I²C serial bus protocol follows (see Figure 33 and Figure 34):

1. The master initiates a data transfer by establishing a start condition, such that SDA goes from high to low while SCL is high (Figure 33). The following byte is the slave address byte, which consists of the 5 MSB of a slave address defined as 01011. The next two bits are AD1 and AD0, I²C device address bits. Depending on the states of their AD1 and AD0 bits, four AD5253/AD5254s can be addressed on the same bus. The last LSB, the $\overline{R/W}$ bit, determines whether data is read from or written to the slave device.

The slave whose address corresponds to the transmitted address responds by pulling the SDA line low during the ninth clock pulse (this is called an acknowledge bit). At this stage, all other devices on the bus remain idle while the selected device waits for data to be written to or read from its serial register.

2. In the write mode (except when restoring EEMEM to the RDAC register), there is an instruction byte that follows the slave address byte. The MSB of the instruction byte labeled $\overline{CMD/REG}$. MSB = 1 enables \overline{CMD} , the command instruction byte; MSB = 0 enables general register writing. The third MSB in the instruction byte, labeled $\overline{EE/RDAC}$, is true only when MSB = 0 or in general writing mode. EE enables the EEMEM register and REG enables the RDAC

register. The 5 LSB, A4 to A0, designed the addresses of the EEMEM and RDAC registers; see Figure 27 and Figure 28. When MSB = 1 or when in CMD mode, the four bits following MSB are C3 to C1, which correspond to 12 predefined EEMEM controls and quick commands; there are also four factory reserved commands. The 3 LSB—A2, A1, and A0—are 4-channel RDAC addresses (see Figure 31). After acknowledging the instruction byte, the last byte in the write mode is the data byte. Data is transmitted over the serial bus in sequences of nine clock pulses (eight data bits followed by an acknowledge bit). The transitions on the SDA line must occur during the low period of SCL and remain stable during the high period of SCL (Figure 33).

3. In current read mode, the RDAC0 data byte immediately follows the acknowledgment of the slave address byte. After an acknowledgement, RDAC1 follows, then RDAC2, and so on (there is a slight difference in write mode, where the last eight data bits representing RDAC3 data are followed by a no acknowledge bit). Similarly, the transitions on the SDA line must occur during the low period of SCL and remain stable during the high period of SCL (see Figure 34). Another reading method, random read method, is shown in Figure 30.
4. When all data bits have been read or written, a stop condition is established by the master. A stop condition is defined as a low-to-high transition on the SDA line while SCL is high. In write mode, the master pulls the SDA line high during the 10th clock pulse to establish a stop condition (Figure 33). In read mode, the master issues a no acknowledge for the ninth clock pulse, i.e., the SDA line remains high. The master then brings the SDA line low before the 10th clock pulse, which goes high to establish a stop condition (Figure 34).

THEORY OF OPERATION

The AD5253/AD5254 are quad-channel digital potentiometers in 1 k Ω , 10 k Ω , 50 k Ω , or 100 k Ω that allow 64/256 linear resistance step adjustments. The AD5253/AD5254 employ double-gate CMOS EEPROM technology that allows resistance settings and user-defined data stored in the EEMEM registers. The EEMEM is nonvolatile such that settings remain when power is removed. The RDAC wiper settings are restored from the nonvolatile memory settings during device power-up and can also be restored at any time during operation.

The AD5253/AD5254 resistor wiper positions are determined by the RDAC register contents. The RDAC register acts like a scratch-pad register, allowing unlimited changes of resistance settings. RDAC register contents can be changed using the device's serial I²C interface. The format of the data-words and the commands to program the RDAC registers are discussed in the I²C Interface section.

The four RDAC registers have corresponding EEMEM memory locations that provide nonvolatile storage of resistor wiper position settings. The AD5253/AD5254 provide commands to store the RDAC register contents to their respective EEMEM memory locations. During subsequent power-on sequences, the RDAC registers are automatically loaded with the stored value.

Whenever the EEMEM write operation is enabled, the device activates the internal charge pump and raises the EEMEM cell gate bias voltage to a high level; this essentially erases the current content in the EEMEM register and allows subsequent storage of the new content. Saving data to an EEMEM register consumes about 35 mA of current and lasts approximately 26 ms. Because of charge pump operation, all RDAC channels may experience noise coupling during the EEMEM writing operation.

The EEMEM restore time in power-up or during operation is about 300 μ s. Note that the power-up EEMEM refresh time depends on how fast V_{DD} reaches its final value. As a result, any supply voltage decoupling capacitors limit the EEMEM restore time during power-up. Figure 20 shows the power-up profile where V_{DD}, without any decoupling capacitors connected to it, is applied with a digital signal. The device initially resets the RDACs to midscale before restoring the EEMEM contents.

In addition, users should issue a NOP command 0 immediately after using command 1 to restore the EEMEM setting to RDAC, thereby minimizing supply current dissipation. Reading user data directly from EEMEM does not require a similar NOP command execution.

In addition to the movement of data between RDAC registers and EEMEM memory, the AD5253/AD5254 provide other shortcut commands that facilitate the user's programming needs, as shown in Table 11.

Table 11. AD5253/AD5254 Quick Commands

Command	Description
0	NOP.
1	Restore EEMEM Content to RDAC. User should issue NOP immediately after this command to conserve power.
2	Store RDAC Register Setting to EEMEM.
3	Decrement RDAC 6 dB (Shift Data Bits Right).
4	Decrement All RDACs 6 dB (Shift All Data Bits Right).
5	Decrement RDAC One Step.
6	Decrement All RDACs One Step.
7	Reset EEMEM Contents to All RDACs.
8	Increment RDAC 6 dB (Shift Data Bits Left).
9	Increment All RDACs 6 dB (Shift All Data Bits Left).
10	Increment RDAC One Step.
11	Increment All RDACs One Step.
12–15	Reserved.

LINEAR INCREMENT AND DECREMENT COMMANDS

The increment and decrement commands (#10, #11, #5, #6) are useful for linear step adjustment applications. These commands simplify microcontroller software coding by allowing the controller to send just an increment or decrement command to the AD5253/AD5254. The adjustments can be directed to a single RDAC or to all four RDACs.

± 6 dB ADJUSTMENTS (DOUBLING/HALVING WIPER SETTING)

The AD5253/AD5254 accommodate ± 6 dB adjustments of the RDAC wiper positions by shifting the register contents to left/right for increment/decrement operations, respectively. Commands 3, 4, 8, and 9 can be used to increment or decrement the wiper positions in 6 dB steps synchronously or asynchronously.

Incrementing the wiper position by +6 dB is essentially doubling the RDAC register value, while decrementing by -6 dB is halving the register content. Internally, the AD5253/AD5254 use shift registers to shift the bits left and right to achieve a ± 6 dB increment or decrement. The maximum number of adjustments is nine and eight steps for increment from zero scale and decrement from full scale, respectively. These functions are useful for various audio/video level adjustments, especially white LED brightness settings where the visual responses of humans are more sensitive to large rather small adjustments.

DIGITAL INPUT/OUTPUT CONFIGURATION

SDA is a digital input/output with an open-drain MOSFET that requires a pull-up resistor for proper communication. On the other hand, SCL and \overline{WP} are digital inputs with pull-up resistors recommended to minimize the MOSFET cross-conduction when the driving signals are lower than V_{DD} . SCL and \overline{WP} have ESD protection diodes, as shown in Figure 35 and Figure 36.

\overline{WP} can be permanently tied to V_{DD} without a pull-up resistor if the write-protect feature is not used. If \overline{WP} is left floating, an internal current source will pull it low to enable write-protect. In applications where the device is not being programmed on a frequent basis, this allows the part to default to write-protect after any one-time factory programming or field calibration without using an on-board pull-down resistor. Since there are protection diodes on all these inputs, their signal levels must not be greater than V_{DD} to prevent forward biasing of the diodes.

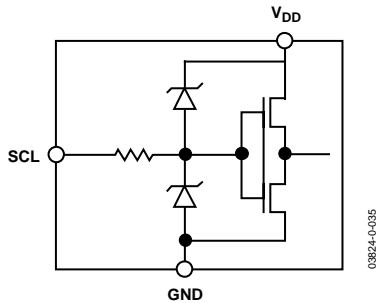

Figure 35. SCL Digital Input

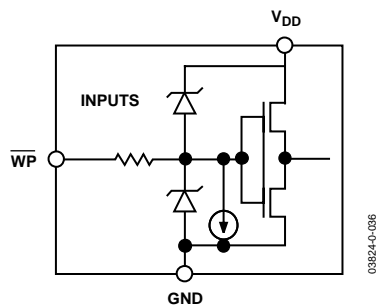

Figure 36. Equivalent \overline{WP} Digital Input

MULTIPLE DEVICES ON ONE BUS

AD5253/AD5254 are equipped with two addressing pins, AD1 and AD0, that allow up to four AD5253/AD5254s to be operated on one I²C bus. To achieve this result, the states of AD1 and AD0 on each device must first be defined. An example is shown in Table 12 and Figure 37. In I²C programming, each device is issued a different slave address—01011(AD1)(AD0)—to complete the addressing.

Table 12. Multiple Devices Addressing

AD1	AD0	Device Addressed
0	0	U1
0	1	U2
1	0	U3
1	1	U4

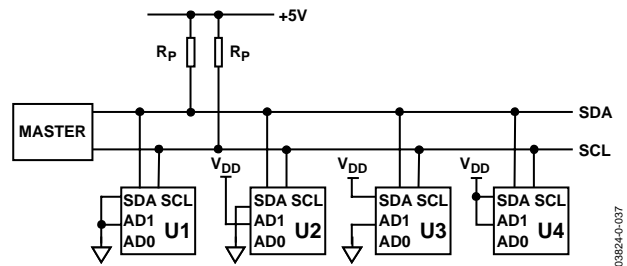

Figure 37. Multiple AD5253/AD5254s on a Single Bus

In wireless base station smart antenna systems where arrays of digital potentiometers may be needed to bias the power amplifiers, large numbers of AD5253/AD5254s can be addressed by using extra decoders, switches, and I/O buses, as shown in Figure 38. For example, to communicate to a total of 16 devices, four decoders and 16 sets of combinational switches (four sets shown in Figure 36) are needed. Two I/O buses serve as the common inputs of the four 2 × 4 decoders and select four sets of outputs at each combination. Because the four sets of combination switch outputs are unique, as shown in Figure 38, a specific device is addressed by proper I²C programming with the slave address defined as 01011(AD1)(AD0). This operation allows one out of 16 devices to be addressed, provided the inputs of the two decoders do not change states. The decoders' inputs are allowed to change once the operation of the specified device is completed.

AD5253/AD5254

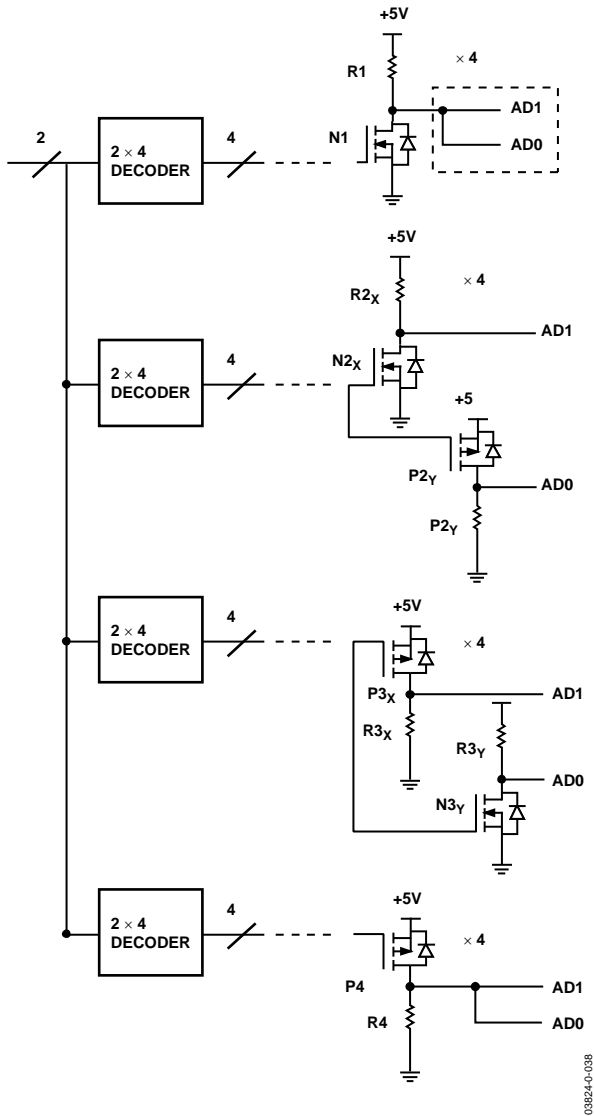

Figure 38. Four Devices with AD1 and AD0 of 00

TERMINAL VOLTAGE OPERATION RANGE

The AD5253/AD5254 are designed with internal ESD diodes for protection; these diodes also set the boundary of the terminal operating voltages. Positive signals present on terminal A, B, or W that exceed V_{DD} are clamped by the forward biased diode. Similarly, negative signals on terminal A, B, or W that are more negative than V_{SS} are also clamped (see Figure 39). In practice, users should not operate V_{AB} , V_{WA} , and V_{WB} to be higher than the voltage across V_{DD} -to- V_{SS} , but V_{AB} , V_{WA} , and V_{WB} have no polarity constraint.

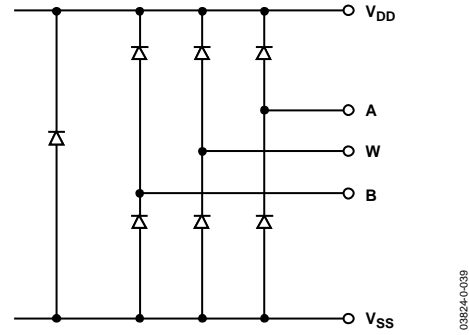

Figure 39. Maximum Terminal Voltages Set by V_{DD} and V_{SS}

POWER-UP AND POWER-DOWN SEQUENCES

Since the ESD protection diodes limit the voltage compliance at terminals A, B, and W (Figure 39), it is important to power V_{DD}/V_{SS} before applying any voltage to terminals A, B, and W. Otherwise, the diodes are forward-biased such that V_{DD}/V_{SS} are powered unintentionally and may affect the rest of the user's circuit. Similarly, V_{DD}/V_{SS} should be powered down last. The ideal power-up sequence is in the following order: GND, V_{DD} , V_{SS} , digital inputs, and $V_A/V_B/V_W$. The order of powering V_A , V_B , V_W , and the digital inputs is not important, as long as they are powered after V_{DD}/V_{SS} .

LAYOUT AND POWER SUPPLY BIASING

It is always a good practice to employ a compact, minimum lead-length layout design. The leads to the input should be as direct as possible, with a minimum conductor length. Ground paths should have low resistance and low inductance.

Similarly, it is also good practice to bypass the power supplies with quality capacitors. Low ESR (equivalent series resistance) 1 μF to 10 μF tantalum or electrolytic capacitors should be applied at the supplies to minimize any transient disturbance and filter low frequency ripple. Figure 40 illustrates the basic supply-bypassing configuration for the AD5253/AD5254.

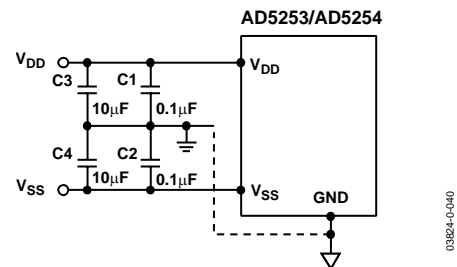

Figure 40. Power Supply Bypassing

The ground pin of the AD5253/AD5254 is used primarily as a digital ground reference. To minimize the digital ground bounce, the AD5253/AD5254 ground terminal should be joined remotely to the common ground (see Figure 40).

DIGITAL POTENTIOMETER OPERATION

The structure of the RDAC is designed to emulate the performance of a mechanical potentiometer. The RDAC contains a string of resistor segments, with an array of analog switches acting as the wiper connection to the resistor array. The number of points is the resolution of the device. For example, the AD5253/AD5254 emulates 64/256 connection points with 64/256 equal resistance, R_s , allowing it to provide better than 1.5%/0.4% settability resolution. Figure 41 provides an equivalent diagram of the connections between the three terminals that make up one channel of the RDAC. Switches SW_A and SW_B are always ON, while one of switches $SW(0)$ to $SW(2^N-1)$ is ON one at a time, depending on the setting decoded from the data bit. Since the switches are nonideal, there is a $75\ \Omega$ wiper resistance, R_w . Wiper resistance is a function of supply voltage and temperature; lower supply voltages and higher temperatures result in higher wiper resistances. Consideration of wiper resistance dynamics is important in applications where accurate prediction of output resistance is required.

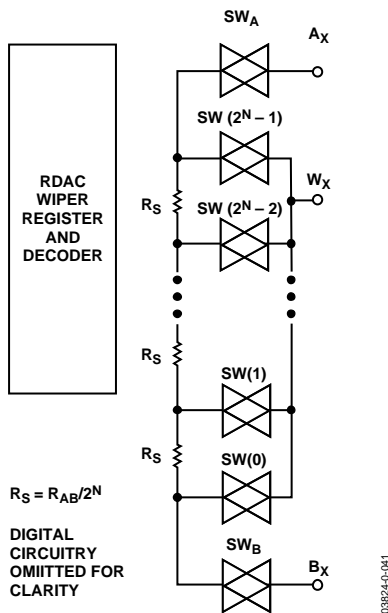

Figure 41. Equivalent RDAC Structure

PROGRAMMABLE RHEOSTAT OPERATION

If either the W-to-B or W-to-A terminal is used as a variable resistor, the unused terminal can be opened or shorted with W; such operation is called rheostat mode (see Figure 42). The resistance tolerance can range $\pm 20\%$.

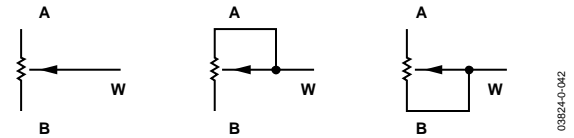

Figure 42. Rheostat Mode Configuration

The nominal resistance of the AD5253/AD5254 has 64/256 contact points accessed by the wiper terminal, plus the B terminal contact. The 6-/8-bit data-word in the RDAC register is decoded to select one of the 64/256 settings. The wiper's first connection starts at the B terminal for data 0x00. This B terminal connection has a wiper contact resistance, R_w , of $75\ \Omega$, regardless of the nominal resistance. The second connection (AD5253 10 k Ω part) is the first tap point where $R_{WB} = 231\ \Omega$ [$R_{WB} = R_{AB}/64 + R_w = 156\ \Omega + 75\ \Omega$] for data 0x01, and so on. Each LSB data value increase moves the wiper up the resistor ladder until the last tap point is reached at $R_{WB} = 9893\ \Omega$. See Figure 41 for a simplified diagram of the equivalent RDAC circuit.

The general equation that determines the digitally programmed output resistance between W and B, is

$$R_{WB}(D) = (D/64) \times R_{AB} + 75\ \Omega \text{ (AD5253)} \tag{1}$$

$$R_{WB}(D) = (D/256) \times R_{AB} + 75\ \Omega \text{ (AD5254)} \tag{2}$$

Where D is the decimal equivalent data contained in the RDAC latch, and R_{AB} is the nominal end-to-end resistance.

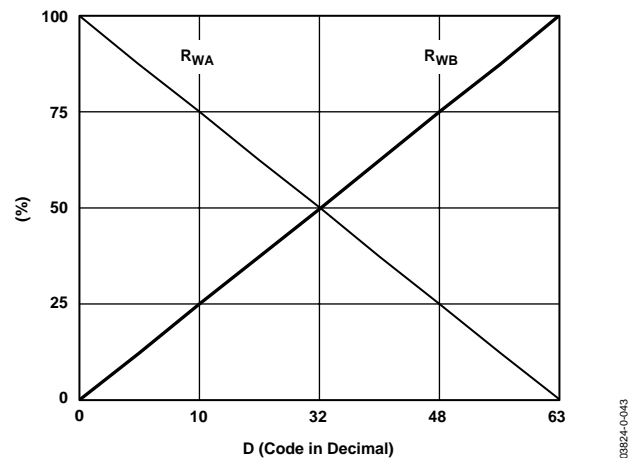

Figure 43. AD5253 $R_{WA}(D)$ and $R_{WB}(D)$ vs. Decimal Code

AD5253/AD5254

For example, the R_{WB} values shown in Table 13 can be found on AD5253 10 k Ω parts.

Table 13. R_{WB} vs. Codes; $R_{AB} = 10$ k Ω , A terminal = Open

D (DEC)	R_{WB} (Ω)	Output State
63	9918	Full Scale
32	5075	Midscale
1	231	1 LSB
0	75	Zero Scale (Wiper Resistance)

Note that in the zero-scale condition, a 75 Ω finite wiper resistance is present. Care should be taken to limit the current conduction between W and B in this state to no more than ± 5 mA continuous for a total resistance of 1 k Ω , or a ± 20 mA pulse, to avoid degradation or possible destruction of the internal switch contact.

Similar to the mechanical potentiometer, the resistance of the RDAC between wiper W and terminal A also produces a digitally controlled complementary resistance, R_{WA} . When these terminals are used, the B terminal can be opened. Setting the resistance value for R_{WA} starts at a maximum value of resistance and decreases as the data loaded in the latch increases in value (see Figure 41). The general equation for this operation is

$$R_{WA}(D) = [(64 - D)/64] \times R_{AB} + 75 \Omega \quad (AD5253) \quad (3)$$

$$R_{WA}(D) = [(256 - D)/256] \times R_{AB} + 75 \Omega \quad (AD5254) \quad (4)$$

Table 14. R_{WA} vs. Codes; AD5253, $R_{AB} = 10$ k Ω , B terminal = Open

D (DEC)	R_{WA} (Ω)	Output State
63	231	Full-Scale
32	5075	Midscale
1	9918	1 LSB
0	10075	Zero-Scale

The typical distribution of R_{AB} from channel-to-channel matches is about $\pm 0.15\%$ within a given device. On the other hand, device-to-device matching is process lot dependent with a $\pm 20\%$ tolerance.

PROGRAMMABLE POTENTIOMETER OPERATION

If all three terminals are used, the operation is called potentiometer mode and the most common configuration is the voltage divider operation (see Figure 44).

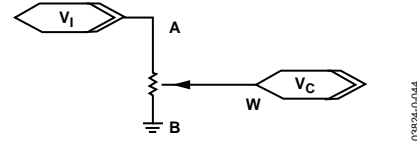

Figure 44. Potentiometer Mode Configuration

If the wiper resistance is ignored, the transfer function is simply

$$V_W = \frac{D}{64} \times V_{AB} + V_B \quad (AD5253) \quad (5)$$

$$V_W = \frac{D}{256} \times V_{AB} + V_B \quad (AD5254) \quad (6)$$

A more accurate calculation, which includes the wiper resistance effect, yields

$$V_W(D) = \frac{\frac{D}{2^N} R_{AB} + R_W}{R_{AB} + 2R_W} V_A \quad (7)$$

Where 2^N is the number of steps. Unlike in rheostat mode operation where the tolerance is high, potentiometer mode operation yields an almost ratiometric function of $D/2^N$ with a relatively small error contributed by the R_W terms. Therefore, the tolerance effect is almost cancelled. Similarly, the ratiometric adjustment also reduces the temperature coefficient effect to 50 ppm/ $^{\circ}$ C, except at low value codes where R_W dominates.

Potentiometer mode operations include other applications such as op amp input, feedback resistor networks, and other voltage scaling applications. The A, W, and B terminals can in fact be input or output terminals, provided $|V_A|$, $|V_W|$, and $|V_B|$ do not exceed V_{DD} -to- V_{SS} .

APPLICATIONS

RGB LED LCD BACKLIGHT CONTROLLER

High power (>1 W) RGB LEDs have been improved so dramatically in efficiency and cost that they are likely to replace CCFLs (cold cathode fluorescent lamps) as backlighting sources in high end LCD panels in the near future. Unlike conventional LEDs, high power LEDs have a forward voltage of 2 V to 4 V, and consume more than 350 mA at maximum brightness. The LED brightness is a linear function of the conduction current but not the forward voltage. To increase brightness of a given color, multiple LEDs can be connected in series, rather than in parallel, to achieve uniform brightness. For example, three red LEDs configured in series require an average of 6 V to 12 V voltage headroom, but the circuit operation requires current control. As a result, Figure 45 shows the implementation of one high power RGB LED controller using a digital potentiometer AD5254, a boost regulator, an op amp, and power MOSFETs.

The ADP1610 (U2 in Figure 45) is an adjustable boost regulator with its output adjusted by the AD5254's RDAC3. Such an output should be set high enough for proper operation but low enough to conserve power. The ADP1610's 1.2 V band gap reference is buffered to provide the reference level for the voltage dividers set by the AD5254's RDAC0 to RDAC2 and resistors R2 to R4. For example, by adjusting the AD5254's RDAC0, the desirable voltage appears across the sense resistors, R_R . If U2's output is set properly, op amp U3A and power MOSFET N1 do whatever is necessary to regulate the current of the loop. As a result, the current through the sense resistor and the red LEDs is

$$I_R = \frac{V_{RR}}{R_R} \quad (8)$$

R_8 is needed to prevent oscillation.

In addition to the 256 levels of adjustable current/brightness, users may also apply a PWM signal at U3's \overline{SD} pin to achieve finer brightness resolution or better power efficiency.

AD5253/AD5254

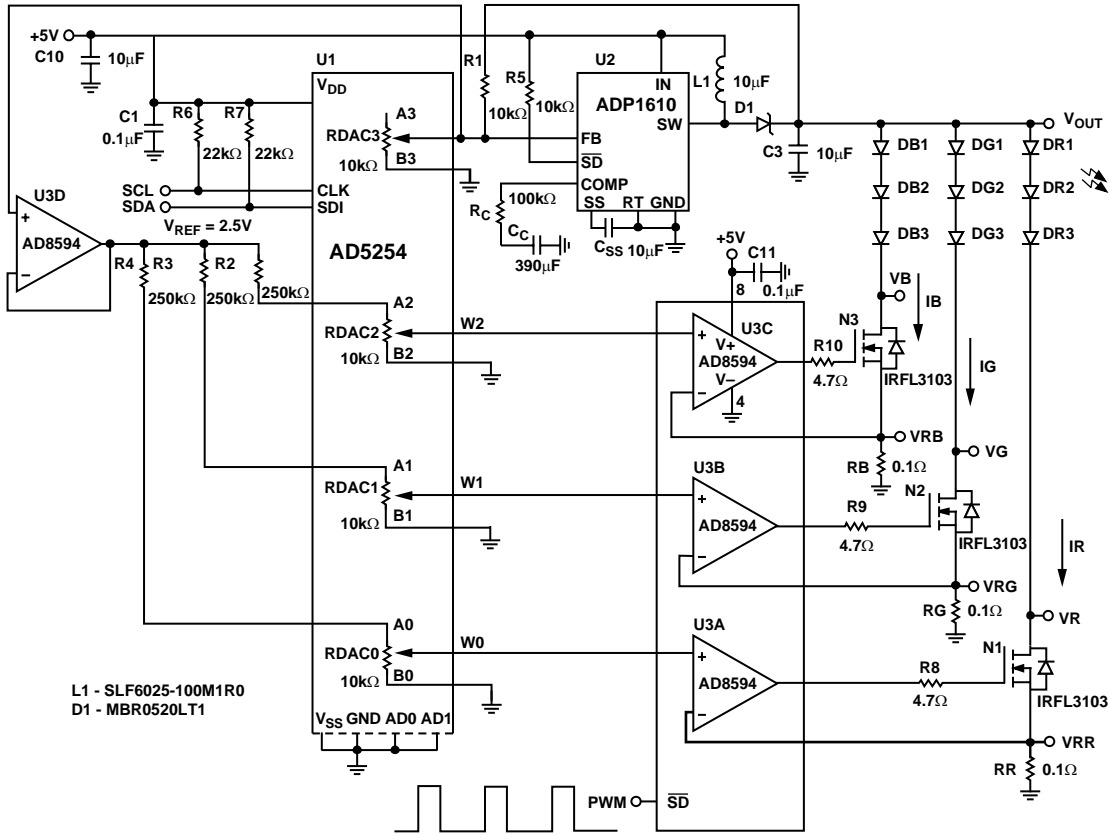
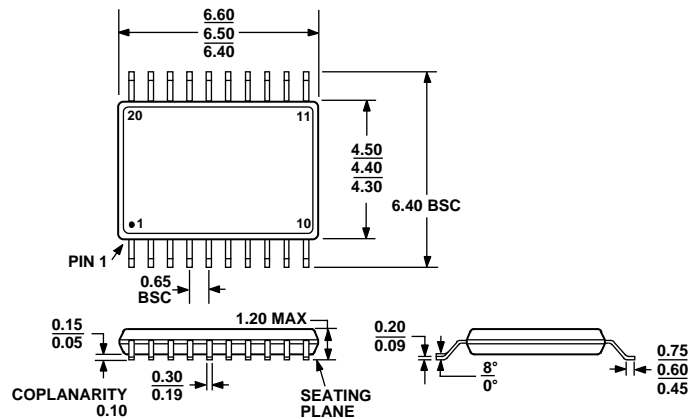

Figure 45. Digital Potentiometer-Based RGB LED Controller

03824-0-045

OUTLINE DIMENSIONS



COMPLIANT TO JEDEC STANDARDS MO-153AC

Figure 46. 20-Lead Thin Shrink Small Outline Package [TSSOP]
(RU-20)
Dimensions shown in millimeters

ORDERING GUIDE

Model	Step	R _{AB} (kΩ)	Temperature Range	Package Description	Package Option	Full Container Quantity
AD5253BRU1	64	1	-40°C to +85°C	Thin Shrink Small Outline Package (TSSOP)	RU-20	75
AD5253BRU1-RL7	64	1	-40°C to +85°C	Thin Shrink Small Outline Package (TSSOP)	RU-20	1,000
AD5253BRU10	64	10	-40°C to +85°C	Thin Shrink Small Outline Package (TSSOP)	RU-20	75
AD5253BRU10-RL7	64	10	-40°C to +85°C	Thin Shrink Small Outline Package (TSSOP)	RU-20	1,000
AD5253BRU50	64	50	-40°C to +85°C	Thin Shrink Small Outline Package (TSSOP)	RU-20	75
AD5253BRU50-RL7	64	50	-40°C to +85°C	Thin Shrink Small Outline Package (TSSOP)	RU-20	1,000
AD5253BRU100	64	100	-40°C to +85°C	Thin Shrink Small Outline Package (TSSOP)	RU-20	75
AD5253BRU100-RL7	64	100	-40°C to +85°C	Thin Shrink Small Outline Package (TSSOP)	RU-20	1,000
AD5253EVAL	64	10		Evaluation Board		1
AD5254BRU1	256	1	-40°C to +85°C	Thin Shrink Small Outline Package (TSSOP)	RU-20	75
AD5254BRU1-RL7	256	1	-40°C to +85°C	Thin Shrink Small Outline Package (TSSOP)	RU-20	1,000
AD5254BRU10	256	10	-40°C to +85°C	Thin Shrink Small Outline Package (TSSOP)	RU-20	75
AD5254BRU10-RL7	256	10	-40°C to +85°C	Thin Shrink Small Outline Package (TSSOP)	RU-20	1,000
AD5254BRU50	256	50	-40°C to +85°C	Thin Shrink Small Outline Package (TSSOP)	RU-20	75
AD5254BRU50-RL7	256	50	-40°C to +85°C	Thin Shrink Small Outline Package (TSSOP)	RU-20	1,000
AD5254BRU100	256	100	-40°C to +85°C	Thin Shrink Small Outline Package (TSSOP)	RU-20	75
AD5254BRU100-RL7	256	100	-40°C to +85°C	Thin Shrink Small Outline Package (TSSOP)	RU-20	1,000
AD5254EVAL	256	10		Evaluation Board		1

NOTES

Purchase of licensed I²C components of Analog Devices or one of its sublicensed Associated Companies conveys a license for the purchaser under the Philips I²C Patent Rights to use these components in an I²C system, provided that the system conforms to the I²C Standard Specification as defined by Philips.