

NPN Silicon Phototransistors

Types OP506A, OP506B, OP506C, OP506D

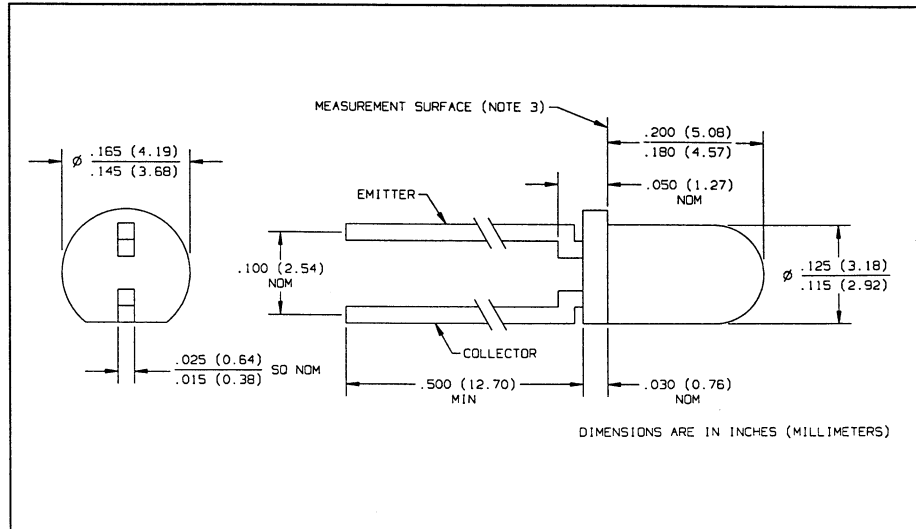
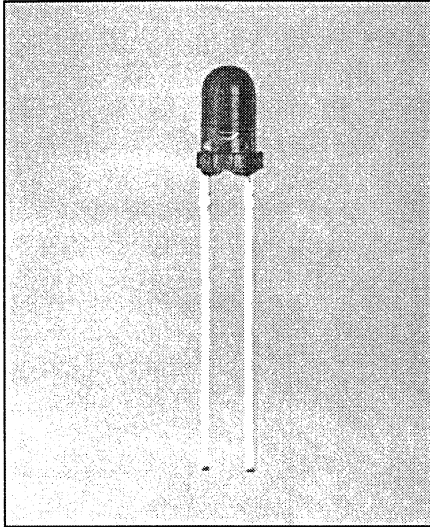

Features

- Narrow receiving angle
- Variety of sensitivity ranges
- T-1 package style
- Small package size for space limited applications

Description

The OP506 series devices consist of NPN silicon phototransistors molded in blue tinted epoxy packages. The narrow receiving angle provides excellent on-axis coupling. These devices are 100% production tested using infrared light for close correlation with Optek's GaAs and GaAlAs emitters. Lead spacing is 0.100" (2.54mm).

Absolute Maximum Ratings ($T_A = 25^\circ\text{C}$ unless otherwise noted)

Collector-Emitter Voltage	30 V
Emitter-Collector Voltage	5.0 V
Storage and Operating Temperature Range	-40°C to $+100^\circ\text{C}$
Lead Soldering Temperature [1/16 inch (1.6 mm) from case for 5 sec. with soldering iron]	$260^\circ\text{C}^{(1)}$
Power Dissipation	100 mW ⁽²⁾

Notes:

- (1) RMA flux is recommended. Duration can be extended to 10 sec. max. when flow soldering. Max. 20 grams force may be applied to leads when soldering.
- (2) Derate linearly 1.33 mW/ $^\circ\text{C}$ above 25°C .
- (3) Light source is an unfiltered GaAs LED with a peak emission wavelength of 935 nm and a radiometric intensity level which varies less than 10% over the entire lens surface of the phototransistor being tested.
- (4) To calculate typical collector dark current in μA , use the formula $I_{CED} = 10^{(0.040 T_A - 3.4)}$ where T_A is ambient temperature in $^\circ\text{C}$.

Typical Performance Curves

Typical Spectral Response

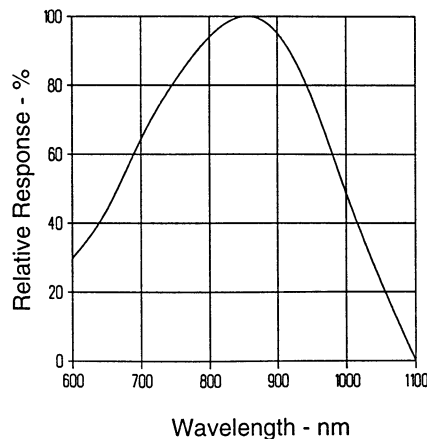

Coupling Characteristics of OP166 and OP506

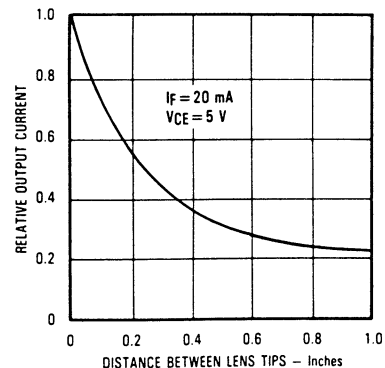

Types OP506A, OP506B, OP506C, OP506D

Electrical Characteristics ($T_A = 25^\circ\text{C}$ unless otherwise noted)

SYMBOL	PARAMETER	MIN	TYP	MAX	UNITS	TEST CONDITIONS
$I_{C(ON)}$	On-State Collector Current	OP506D	0.55		mA	$V_{CE} = 5\text{ V}, E_e = 0.50\text{ mW/cm}^2$ ⁽⁴⁾
		OP506C	1.10	3.00	mA	$V_{CE} = 5\text{ V}, E_e = 0.50\text{ mW/cm}^2$ ⁽⁴⁾
		OP506B	2.15	5.95	mA	$V_{CE} = 5\text{ V}, E_e = 0.50\text{ mW/cm}^2$ ⁽⁴⁾
		OP506A	4.30		mA	$V_{CE} = 5\text{ V}, E_e = 0.50\text{ mW/cm}^2$ ⁽⁴⁾
$\Delta I_C/\Delta T$	Relative I_C Changes with Temperature		1.00		%/ $^\circ\text{C}$	$V_{CE} = 5\text{ V}, E_e = 1.0\text{ mW/cm}^2$
I_{CEO}	Collector Dark Current			100	nA	$V_{CE} = 10\text{ V}, E_e = 0$ ⁽⁴⁾
$V_{(BR)CEO}$	Collector-Emitter Breakdown Voltage	30			V	$I_C = 100\text{ }\mu\text{A}$
$V_{(BR)ECO}$	Emitter-Collector Breakdown Voltage	5.0			V	$I_E = 100\text{ }\mu\text{A}$
$V_{CE(SAT)}$	Collector-Emitter Saturation Voltage			0.40	V	$I_C = 250\text{ mA}, E_e = 0.50\text{ mW/cm}^2$ $\lambda = 935\text{ nm}$ ⁽³⁾

PHOTOSENSORS

Typical Performance Curves

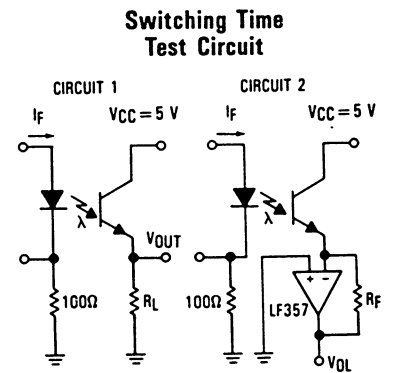
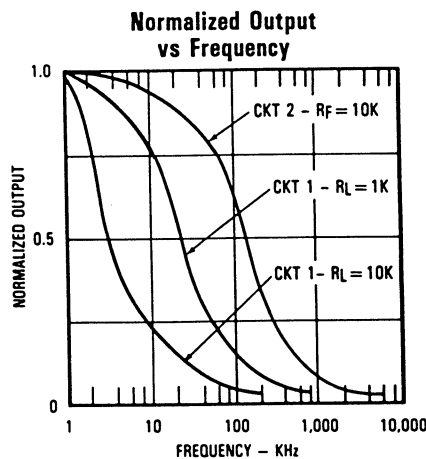
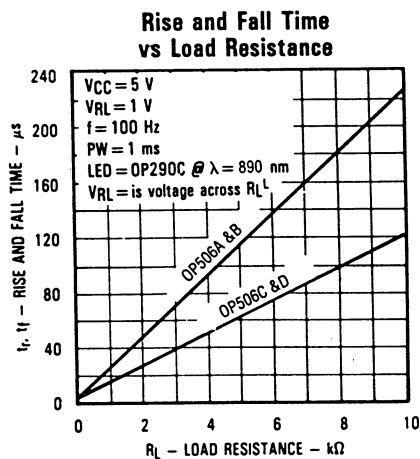
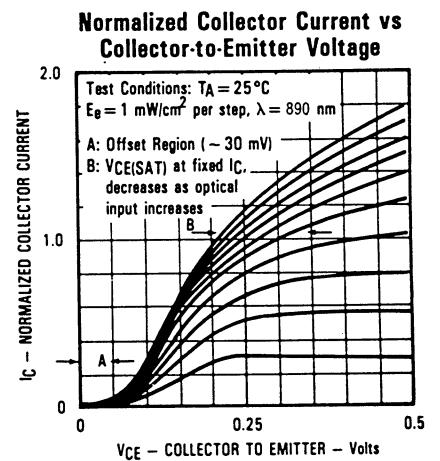
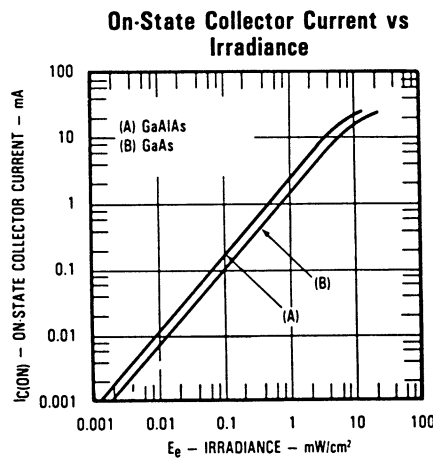
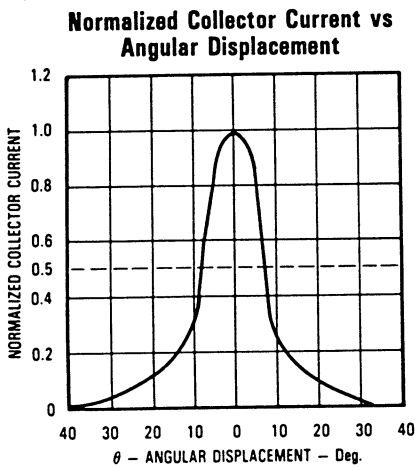

Test Conditions:
Light source is pulsed LED with t_r and $t_f \leq 500\text{ ns}$.
 I_f is adjusted for $V_{OUT} = 1\text{ Volt}$.