

Nomenclature

318-1522

■ Digital Operator

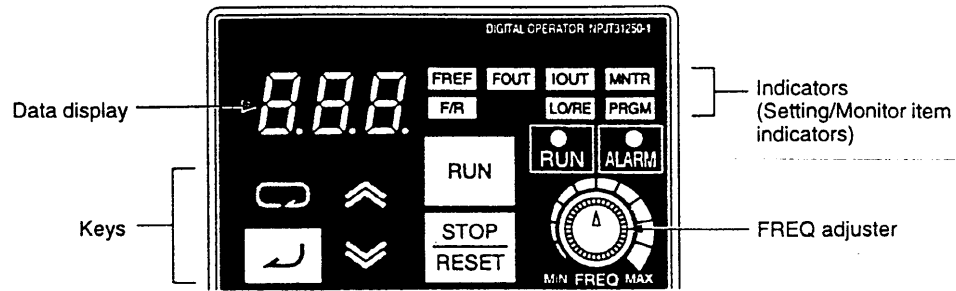

Appearance	Name	Function
	Data display	Displays relevant data items, such as frequency reference, output frequency, and parameter set values.
	Frequency adjuster	Sets the frequency reference within a range between 0 Hz and the maximum frequency.
	Frequency reference indicator	The frequency reference can be monitored or set while this indicator is lit.
	Output frequency indicator	The output frequency of the Inverter can be monitored while this indicator is lit.
	Output current indicator	The output current of the Inverter can be monitored while this indicator is lit.
	Multi-function monitor indicator	The values set in U01 through U10 are monitored while this indicator is lit.
	Forward/Reverse selection indicator	The direction of rotation can be selected while this indicator is lit when operating the Inverter with the RUN Key.
	Local/Remote selection indicator	The operation of the Inverter through the Digital Operator or according to the set parameters is selectable while this indicator is lit. Note This status of this indicator can be only monitored while the Inverter is in operation. Any RUN command input is ignored while this indicator is lit.
	Parameter setting indicator	The parameters in n01 through n79 can be set or monitored while this indicator is lit. Note While the Inverter is in operation, the parameters can be only monitored and only some parameters can be changed. Any RUN command input is ignored while this indicator is lit.
	Mode Key	Switches the setting and monitor item indicators in sequence. Parameter being set will be canceled if this key is pressed before entering the setting.
	Increment Key	Increases multi-function monitor numbers, parameter numbers, and parameter set values.
	Decrement Key	Decreases multi-function monitor numbers, parameter numbers, and parameter set values.
	Enter Key	Enters multi-function monitor numbers, parameter numbers, and internal data values after they are set or changed.
	RUN Key	Starts the Inverter running when the 3G3JV is in operation with the Digital Operator.
	STOP/RESET Key	Stops the Inverter unless parameter n06 is not set to disable the STOP Key.

Using Digital Operator

■ Selecting Indicators

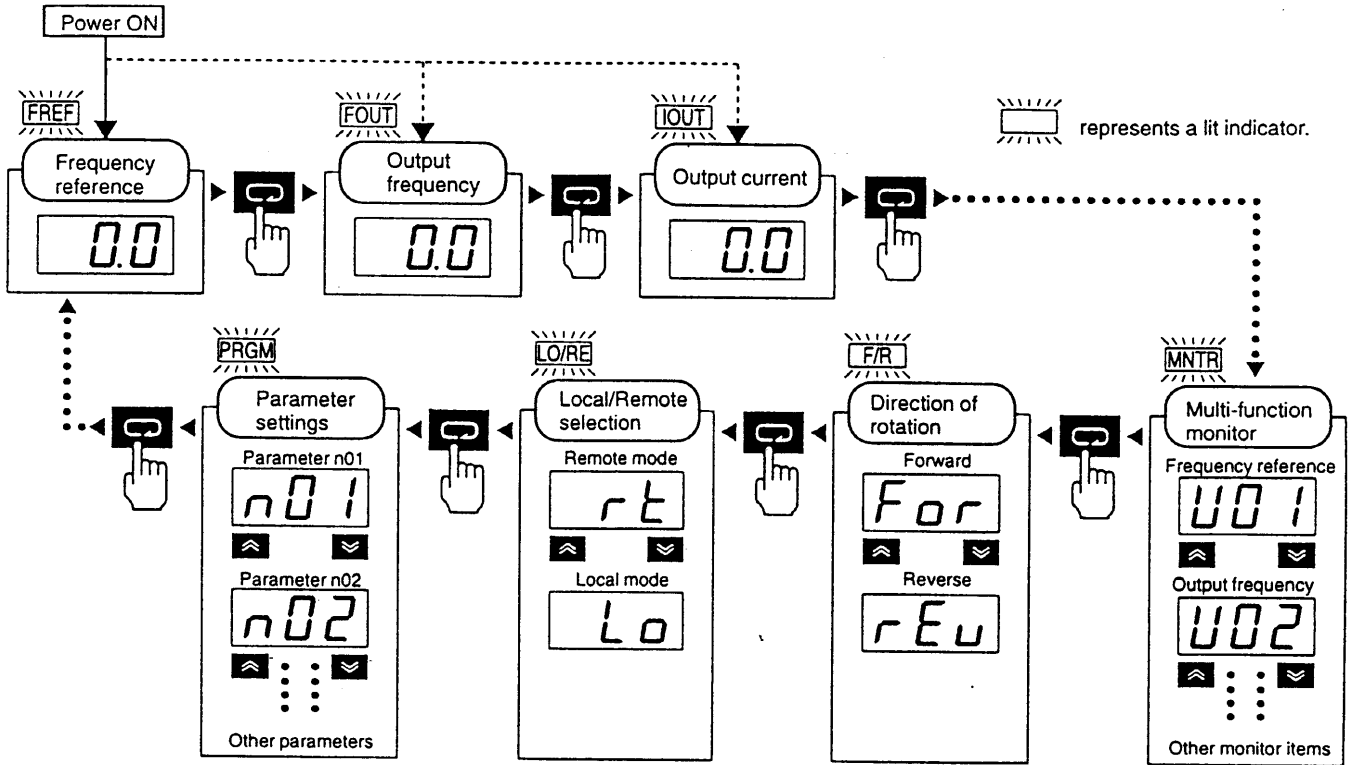

Note: If the power is turned OFF with the FOUT or IOUT indicator lit, the same indicator will light when the power is turned ON again. In other cases, the FREF indicator will light when the power is turned ON.

■ Example of Frequency Reference Settings

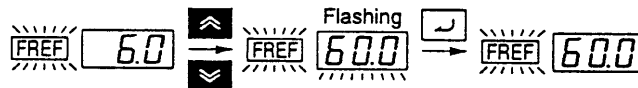

Key sequence	Indicator	Display example	Explanation
	FREF	6.0	Power ON Note If the FREF indicator has not been lit, press the Mode Key repeatedly until the FREF indicator is lit.
↑ ↓	FREF	60.0	Use the Increment or Decrement Key to set the frequency reference. The data display will flash while the frequency reference is set. (see note 1)
↵	FREF	60.0	Press the Enter Key so that the set value will be entered and the data display will be lit. (see note 1)

Note: The Enter Key need not be pressed when performing the setting for n08. The frequency reference will change when the set value is changed with the Increment or Decrement Key while the data display is continuously lit.

Using Digital Operator

Example of Multi-function Display

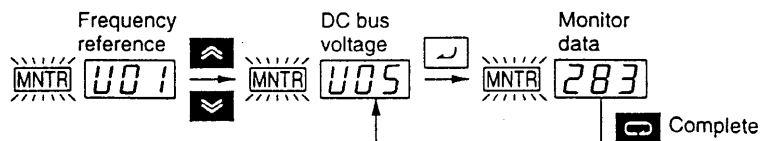

Key sequence	Indicator	Display	Explanation
	FREF	6.0	Power ON
M	MNTR	U01	Press the Mode Key repeatedly until the MNTR indicator is lit. U01 will be displayed.
▲ ▼	MNTR	U05	Use the Increment or Decrement Key to select the monitor item to be displayed.
↵	MNTR	283	Press the Enter Key so that the data of the selected monitor item will be displayed.
M	MNTR	U05	The monitor number display will appear again by pressing the Mode Key.

Status Monitor

Item	Display	Display unit	Function
U01	Frequency reference	Hz	Monitors the frequency reference. (Same as FREF)
U02	Output frequency	Hz	Monitors the output frequency. (Same as FOUT)
U03	Output current	A	Monitors the output current. (Same as IOUT)
U04	Output voltage	V	Monitors the internal output voltage reference value of the Inverter.
U05	DC bus voltage	V	Monitors the DC voltage of the internal main circuit of the Inverter.
U06	Input terminal status	---	Shows the ON/OFF status of inputs.
U07	Output terminal status	---	Shows the ON/OFF status of outputs.
U09	Error log (most recent one)	---	Displays the latest error.
U10	Software No.	---	OMRON use only.

Using Digital Operator

■ Example of Parameter Settings

The following example shows how to set 2 to enable the frequency reference control terminal for 0- to 10-V input in parameter n03 (Frequency Reference Selection).

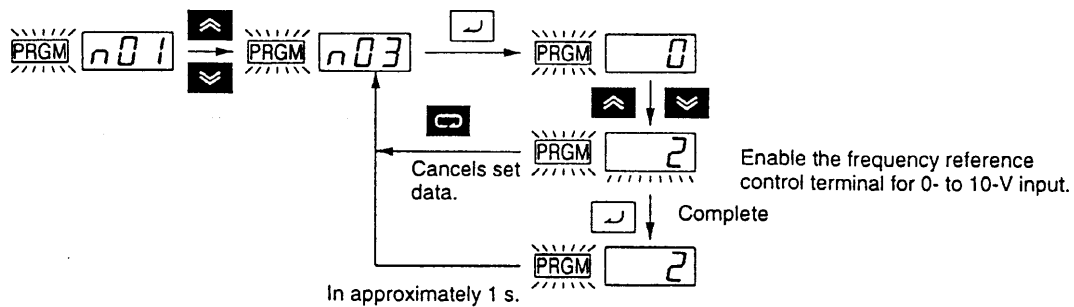

Key sequence	Indicator	Display example	Explanation
	FREF	00	Power ON
[Mode Key]	PRGM	n01	Press the Mode Key repeatedly until the PRGM indicator is lit.
[Increment/Decrement Key]	PRGM	n03	Use the Increment or Decrement Key to set the parameter number.
[Enter Key]	PRGM	0	Press the Enter Key. The data of the selected parameter number will be displayed.
[Increment/Decrement Key]	PRGM	2 (flashing)	Use the Increment or Decrement Key to set the data. At that time the display will flash.
[Enter Key]	PRGM	2 (lit)	Press the Enter Key so that the set value will be entered and the data display will be lit. (see note 1)
In approximately 1 s.	PRGM	n03	The parameter number will be displayed.

- Note:**
1. To cancel the set value, press the Mode Key instead. The parameter number will be displayed.
 2. There are parameters that cannot be changed while the Inverter is in operation. Refer to the list of parameters. When attempting to change such parameters, the data display will not change by pressing the Increment or Decrement Key.

List of Parameters

■ List of Parameters

Parameter No.	Name	Description	Setting range	Unit of setting	Default setting	Changes during operation	Reference page		
n01	Parameter write-prohibit selection/parameter initialization	Used to prohibit parameters to be written, sets parameters, or change the monitor range of parameters. Used to initialize parameters to default values.	0, 1, 6, 8, 9	1	1	No	14		
n02	Operation mode selection	Used to select the input method for the RUN and STOP commands in remote mode.	0, 1	1	0	No	14		
n03	Frequency reference selection	Used to set the input method for the frequency reference in remote mode.	0 to 4	1	0	No	14		
n04	Interruption mode selection	Used to set the stopping method for use when the STOP command is input.	0, 1	1	0	No	14		
n05	Reverse rotation-prohibit selection	Used to select the operation with the reverse command input.	0, 1	1	0	No	14		
n06	STOP/RESET Key function selection	Used to select the stop method in remote mode with n02 for operation mode selection set to 1.	0, 1	1	0	No	14		
n07	Frequency selection in local mode	Used to set the input method for the frequency reference in local mode.	0, 1	1	0	No	14		
n08	Key sequential frequency setting	Used to enable the Enter Key for setting the frequency reference with the Increment and Decrement Keys.	0, 1	1	0	No	14		
n09	Maximum frequency (FMAX)	Used to set the V/f pattern as the basic characteristic of the Inverter with output voltage per frequency set.	50.0 to 400	0.1 Hz	60.0	No	14		
n10	Maximum voltage (VMAX)	Note Set the parameters so that the following condition will be satisfied. $n14 \leq n12 < n11 \leq n09$	1 to 255	1 V	200	No	14		
n11	Maximum voltage frequency (FA)	Note The value set in n15 will be ignored if parameters n14 and n12 are the same in value.	0.2 to 400	0.1 Hz	60.0	No	14		
n12	Middle output frequency (FB)		0.1 to 399	0.1 Hz	1.5	No	14		
n13	Middle output frequency voltage (VC)		1 to 255	1 V	12	No	14		
n14	Minimum output frequency (FMIN)		0.1 to 10.0	0.1 Hz	1.5	No	14		
n15	Minimum output frequency voltage (VMIN)		1 to 50	1 V	12.0	No	14		
n16	Acceleration time 1	Acceleration time: The time required to go from 0% to 100% of the maximum frequency.	0.0 to 999	0.1 s	10.0	Yes	15		
n17	Deceleration time 1	Deceleration time: The time required to go from 100% to 0% of the maximum frequency.			10.0	Yes	15		
n18	Acceleration time 2	Note The actual acceleration or deceleration time is obtained from the following formula. Acceleration/Deceleration time = (Acceleration/Deceleration time set value) × (Frequency reference value) ÷ (Max. frequency)			10.0	Yes	15		
n19	Deceleration time 2				10.0	Yes	15		
n20	S-shape acceleration/deceleration characteristic	Used to set S-shape acceleration/deceleration characteristics.	0 to 3	1	0	No	15		
n21	Frequency reference 1	Used to set internal frequency references. Note Frequency reference 1 is enabled in remote mode with n03 for frequency reference selection set to 1.	0.0 to max. frequency	0.1 Hz	6.0	No	15		
n22	Frequency reference 2				0.0	No	15		
n23	Frequency reference 3	Note These frequency references are selected with multi-step speed references (multi-function input). See the reference pages for the relationship between multi-step speed references and frequency references.			0.0	No	15		
n24	Frequency reference 4				0.0	No	15		
n25	Frequency reference 5				0.0	No	15		
n26	Frequency reference 6				0.0	No	15		
n27	Frequency reference 7				0.0	No	15		
n28	Frequency reference 8				0.0	No	15		
n29	Inching frequency command	Used to set the inching frequency command.			6.0	No	15		

List of Parameters

Parameter No.	Name	Description	Setting range	Unit of setting	Default setting	Changes during operation	Reference page
n30	Frequency reference upper limit	Used to set the upper and lower frequency reference limits in percentage based on the maximum frequency as 100%.	0 to 110	1%	100	No	16
n31	Frequency reference lower limit		0 to 110	1%	0	No	16
n32	Rated motor current	Used to set the rated motor current for motor overload detection (OL1) based on the rated motor current. Note Motor overload detection (OL1) is disabled by setting the parameter to 0.0.	0.0 to 120% of rated output current	0.1 A	Varies with the capacity.	No	16
n33	Motor protection characteristics	Used to set the motor overload detection (OL1) for the electronic thermal characteristics of the motor.	0 to 2	1	0	No	16
n34	Motor protective time setting	Used to set the electric thermal characteristics of the motor to be connected in 1-minute increments.	1 to 60	1 min	8	No	16
n35	Cooling fan operation function	Used to operate the Cooling Fan of the Inverter while the Inverter is turned on or only while the Inverter is in operation.	0, 1	1	0	No	16
n36	Multi-function input 1 (Input terminal S2)	Used to select the functions of multi-function input terminals S2 through S5.	2 to 22	1	2	No	16
n37	Multi-function input 2 (Input terminal S3)		0 to 22	1	5	No	16
n38	Multi-function input 3 (Input terminal S4)		2 to 22	1	3	No	16
n39	Multi-function input 4 (Input terminal S5)		2 to 34	1	6	No	16
n40	Multi-function output (MA/MB and MC output terminals)	Used to select the functions of multi-function output terminals.	0 to 7, 10 to 17	1	1	No	17
n41	Frequency reference gain	Used to the input characteristics of analog frequency references.	0 to 255	1%	100	Yes	17
n42	Frequency reference bias		-99 to 99	1%	0	Yes	17
n43	Analog frequency reference filter time	Used to set the digital filter with a first-order lag for analog frequency references to be input.	0.00 to 2.00	0.01 s	0.10	No	17
n44	Analog monitor output	Used to set the output frequency or current as a monitored item.	0, 1	1	0	No	17
n45	Analog monitor output gain	Used to set the output characteristics of analog monitor output.	0.00 to 2.00	0.01	1.00	Yes	17
n46	Carrier frequency selection	Used to set the carrier frequency.	1 to 4, 7 to 9	1	Varies with the capacity.	No	18
n47	Momentary power interruption compensation	Used to specify the processing that is performed when a momentary power interruption occurs.	0 to 2	1	0	No	18
n48	Fault retry	Used to set the number of times the Inverter is reset and restarted automatically in the case the Inverter has an overvoltage fault, overcurrent fault, or ground fault.	0 to 10	1	0	No	18
n49	Jump frequency 1	Used to set the frequency jump function. Note These values must satisfy the following condition: $n49 \geq n50$	0.0 to 400	0.1 Hz	0.0	No	18
n50	Jump frequency 2		0.0 to 400	0.1 Hz	0.0	No	18
n51	Jump width		0.0 to 400	0.1 Hz	0.0	No	18
n52	DC control current	Used to impose DC on the induction motor for braking control.	0 to 100	1%	50	No	18
n53	Interruption DC control time		0.0 to 25.5	0.1 s	0.5	No	18
n54	Startup DC control time		0.0 to 25.5	0.1 s	0.0	No	18
n55	Stall prevention during deceleration	Used to select a function to change the deceleration time of the motor automatically so that there will be no overvoltage imposed on the motor during deceleration.	0, 1	1	0	No	18
n56	Stall prevention level during acceleration	Used to select a function to stop the acceleration of the motor automatically for stall prevention during acceleration.	30 to 200	1%	170	No	19
n57	Stall prevention level during operation	Used to select a function to reduce the output frequency of the Inverter automatically for stall prevention during operation.	30 to 200	1%	160	No	19

List of Parameters

Parameter No.	Name	Description	Setting range	Unit of setting	Default setting	Changes during operation	Reference page
n58	Frequency detection level	Used to set the frequency to be detected.	0.0 to 400	0.1 Hz	0.0	No	19
n59	Overtorque detection function selection	Used to enable or disable overtorque detection and select the processing method after overtorque detection.	0 to 4	1	0	No	19
n60	Overtorque detection level	Used to set overtorque detection level.	30 to 200	1%	160	No	19
n61	Overtorque detection time	Used to set the detection time of overtorque.	0.1 to 10.0	0.1 s	0.1	No	19
n62	UP/DOWN command frequency memory	Used to store the adjusted frequency reference with the UP/DOWN function.	0, 1	1	0	No	20
n63	Torque compensation gain	Used to set the gain of the torque compensation function.	0.0 to 2.5	0.1	1.0	Yes	21
n64	Motor rated slip	Used to set the rated slip value of the motor in use.	0.0 to 20.0	0.1 Hz	Varies with the capacity.	Yes	21
n65	Motor no-load current	Used to set the no-load current of the motor in use based on the rated motor current as 100%.	0 to 99	1%	Varies with the capacity.	No	21
n66	Slip compensation gain	Used to set the gain of the slip compensation function.	0.0 to 2.5	0.1	0.0	Yes	21
n67	Slip compensation time constant	Used for the response speed of the slip compensation function.	0.0 to 25.5	0.1 s	2.0	No	21
n68 to n74	OMRON's control reference use	Do not change the set value.	---	---	---	---	---
n75	Low-speed carrier frequency reduction selection	Used to select a function to reduce the carrier frequency when Inverter is at low speed.	0.1	1	0	No	---
n76	OMRON's control reference use	Do not change the set value.	---	---	---	---	---
n77							
n78	Error log	Used to display the latest error recorded.  Note "---" will be displayed if no error has been recorded. Note This parameter is monitored only.	---	---	---	---	---
n79	Software number	Used to display the software number of the Inverter for OMRON's control reference use. Note This parameter is monitored only.	---	---	---	---	---

Function of Each Parameter

Note: The shaded values indicate default settings.

Parameter Write-prohibit Selection/Parameter Initialization (n01)

This parameter makes it possible to write-prohibit parameters, change the parameter set or displayed range, or initialize all parameters to default values.

Value	Description
0	Only n01 can be displayed and set. The n02 through n79 parameters can be displayed only.
1	The n01 through n79 parameters can be displayed and set.
6	Only the error log memory is cleared.
8	Enables the initialization of all parameters in 2-wire sequence so that the parameters will return to default values.
9	Enables the initialization of all parameters in 3-wire sequence.

Operation Mode Selection (n02)

Select the method of operation mode input to start or stop the Inverter in remote mode.

Value	Description
0	The RUN and STOP/RESET Keys of the Digital Operator are enabled.
1	Multi-function input in 2- or 3-wire sequence through the control circuit terminals is enabled.

Note: In local mode, RUN commands can be entered using the Digital Operator only.

Frequency Reference Selection (n03) (Remote Mode)

Select the method for inputting the frequency reference to the Inverter in remote mode.

Value	Description
0	The FREQ adjuster of the Digital Operator is enabled.
1	Frequency reference 1 (n21) is enabled.
2	The frequency reference control terminal (for 0- to 10-V input) is enabled.
3	The frequency reference control terminal (for 4- to 20-mA current input) is enabled.
4	The frequency reference control terminal (for 0- to 20-mA current input) is enabled.

Interruption Mode Selection (n04)

Select the stopping method to be used when the STOP command is input.

Value	Description
0	Frequency deceleration stop (Decelerates to stop in preset time.)
1	Free running (Output shut OFF by STOP command.)

Reverse Rotation-prohibit Selection (n05)

Select the operation to be performed when the reverse rotation command is input.

Value	Description
0	Reverse rotation possible (command accepted)
1	Reverse rotation prohibited (command not accepted)

STOP/RESET Key Function Selection (n06)

When parameter n02 is set to 1, set whether or not to use the STOP/RESET Key of the Digital Operator to stop the Inverter in remote mode. The STOP/RESET Key is always enabled in local mode regardless of the setting in n02.

Value	Description
0	The STOP/RESET Key of the Digital Operator is enabled.
1	The STOP/RESET Key of the Digital Operator is disabled.

Frequency Reference Selection (n07) (Local Mode)

Select the input method of frequency references in local mode.

Value	Description
0	The FREQ adjuster of the Digital Operator is enabled.
1	Key sequences on the Digital Operator are enabled.

Key Sequential Frequency Setting (n08)

Select whether to enable the Enter Key when setting the frequency reference with the Increment and Decrement Keys on the Digital Operator.

Value	Description
0	The Enter Key is enabled. (The setting is made valid by pressing the Enter Key.)
1	The Enter Key is disabled. (The setting is directly treated as a frequency reference without the Enter Key being pressed.)

V/f Pattern Settings (n09 to n15)

Set the V/f pattern as the basic characteristic of the Inverter with output voltage per frequency set.

Value	Name	Setting range	Unit of setting	Default settings
n09	Maximum Frequency (FMAX)	50.0 to 400	0.1 Hz	60.0
n10	Maximum Voltage (VMAX)	1 to 255	1 V	200
n11	Maximum Voltage Frequency (FA)	0.2 to 400	0.1 Hz	60.0
n12	Middle Output Frequency (FB)	0.1 to 399	0.1 Hz	1.5
n13	Middle Output Frequency Voltage (VC)	1 to 255	1 V	12
n14	Minimum Output Frequency (FMIN)	0.1 to 10.0	0.1 Hz	1.5
n15	Minimum Output Frequency Voltage (VMIN)	1 to 50	1 V	12.0

Function of Each Parameter

Note: For n09, n11, and n12, the unit of setting is as follows: Values will be set in 0.1-Hz increments if the frequency is less than 100 Hz and 1-Hz increments if the frequency is 100 Hz or greater.

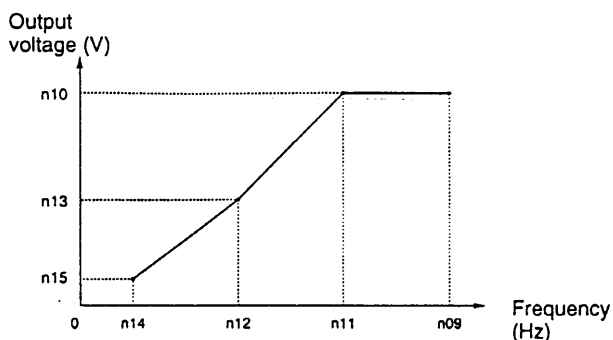

- Note:**
1. Set the parameters so that the following condition will be satisfied.
 $n14 \leq n12 < n11 \leq n09$
 2. The value set in n15 will be ignored if parameters n14 and n12 are the same in value.

Acceleration/Deceleration Time Settings (n16 to n19)

The acceleration time is the time required to go from 0% to 100% of the maximum frequency and the deceleration time is the time required to go from 100% to 0% of the maximum frequency. The actual acceleration or deceleration time is obtained from the following formula.

$$\text{Acceleration/Deceleration time} = (\text{Acceleration/Deceleration time set value}) \times (\text{Frequency reference value}) + (\text{Max. frequency})$$

Value	Name	Setting range	Unit of setting	Default settings
n16	Acceleration time 1	0.0 to 999	0.1 s	10.0
n17	Deceleration Time 1			10.0
n18	Acceleration time 2			10.0
n19	Deceleration Time 2			10.0

S-shape Acceleration/Deceleration Characteristic (n20)

Any one of three S-shape acceleration/deceleration times (0.2, 0.5, and 1.0 s) is selectable.

Value	Description
0	No S-shape acceleration/deceleration characteristic (Trapezoidal acceleration/deceleration)
1	S-shape acceleration/deceleration characteristic time is 0.2 s
2	S-shape acceleration/deceleration characteristic time is 0.5 s
3	S-shape acceleration/deceleration characteristic time is 1.0 s

Note: When the S-shape acceleration/deceleration characteristic time is set, the acceleration and deceleration times will be lengthened according to the S-shape at the beginning and end of acceleration/deceleration.

Setting the Frequency References 1 to 8 and the Inching Frequency Command (n21 to n28 and n29)

Set internal frequency references.

Value	Name	Setting range	Unit of setting	Default settings
n21	Frequency reference 1	0.0 to max. frequency	0.1 Hz (see note 1)	6.0
n22	Frequency reference 2			0.0
n23	Frequency reference 3			0.0
n24	Frequency reference 4			0.0
n25	Frequency reference 5			0.0
n26	Frequency reference 6			0.0
n27	Frequency reference 7			0.0
n28	Frequency reference 8			0.0
n29	Inching frequency command			6.0

- Note:**
1. Values will be set in 0.1-Hz increments if the frequency is less than 100 Hz and 1-Hz increments if the frequency is 100 Hz or over.
 2. Frequency reference 1 is enabled with n03 for frequency reference selection set to 1. (Remote mode)
 3. Frequency references 1 to 8 are enabled by setting multi-step speed references 1, 2, and 3 in n36 to n39 for multi-function input. Refer to the following table for the relationship between multi-step speed references 1 to 3 and frequency references 1 to 8.

Frequency reference	Multi-step speed reference 1	Multi-step speed reference 2	Multi-step speed reference 3
Frequency reference 1	OFF	OFF	OFF
Frequency reference 2	ON	OFF	OFF
Frequency reference 3	OFF	ON	OFF
Frequency reference 4	ON	ON	OFF
Frequency reference 5	OFF	OFF	ON
Frequency reference 6	ON	OFF	ON
Frequency reference 7	OFF	ON	ON
Frequency reference 8	ON	ON	ON

- Note:**
1. "ON" and "OFF" represent "input ON" and "input OFF," respectively.
 2. Inching frequency commands take precedence over multi-step speed references.

Function of Each Parameter

Frequency Reference Upper and Lower Limit Settings (n30 and n31)

Set the upper and lower frequency reference limits in percentage based on the maximum frequency as 100%.

Value	Name	Setting range	Unit of setting	Default settings
n30	Frequency Reference Upper Limit	0 to 110	1%	100
n31	Frequency Reference Lower Limit	0 to 110	1%	0

Note: If n31 is set to a value less than the minimum output frequency (FMIN) (n14), the Inverter will have no output when a frequency reference less than the minimum output frequency input is ON.

Rated Motor Current Setting (n32)

Set the rated motor current as the reference value for motor overload detection (OL1).

Note:

- Setting 0.0 disables the motor overload detection (OL1) function.
- The rated motor current value is factory-set for each Inverter according to the maximum applicable motor capacity.

Value	Name	Setting range	Unit of setting	Default settings
n32	Rated Motor Current	0.0% to 120% (A) of rated output current of Inverter	0.1 A	Varies with the capacity.

Motor Protection Characteristic Selection (n33)

Set the motor overload detection (OL1) for the electronic thermal characteristics of the motor.

Value	Description
0	Protection characteristics for general-purpose induction motors
1	Protection characteristics for Inverter-dedicated motors
2	No protection

Note: When connecting multiple motors to one Inverter, set 2 (equivalent to n32 = 0.0). In addition, take overload prevention measures by mounting a thermal relay in each motor, for example.

Motor Protective Time Setting (n34)

Set the electronic thermal characteristics of the motor to be connected in 1-minute increments.

Value	Name	Setting range	Unit of setting	Default settings
n34	Motor Protective Time Setting	1 to 60	1 min	8

Note:

- The default setting does not need any changes in normal operation.
- To set the parameter according to the characteristics of the motor, confirm the thermal time constant with the motor manufacturer and set the parameter with some margin. In other words, set the value a little shorter than the thermal time constant.
- To detect motor overloading more quickly, reduce the set value, provided that it does not cause any application problems.

Cooling Fan Operation Function Selection (n35)

This parameter is used to operate the cooling fan of the Inverter while the Inverter is turned on or only while the Inverter is in operation.

Value	Description
0	The fan rotates only while the RUN command is input and for 1 minute after the Inverter stops operating.
1	The fan rotates while the Inverter is turned ON.

Note:

- This parameter is available only if the Inverter incorporates a cooling fan.
- If the operation frequency of the Inverter is low, the life of the fan can be prolonged by setting the parameter to 0.

Multi-function Input Selection (n36 to n39)

Select the functions of multi-function input terminals S2 to S5.

Value	Name	Setting range	Unit of setting	Default settings
n36	Multi-function Input 1 (S2)	2 to 8, 10 to 22	1	2
n37	Multi-function Input 2 (S3)	0, 2 to 8, 10 to 22	1	5
n38	Multi-function Input 3 (S4)	2 to 8, 10 to 22	1	3
n39	Multi-function Input 4 (S5)	2 to 8, 10 to 22, 34	1	6

Value	Function	Description
0	Forward/Reverse rotation command	3-wire sequence (to be set in n37 only) This setting overrides the n36 setting. S1: RUN input (RUN when ON) S2: STOP input (STOP when OFF) S3: Forward/Reverse rotation command (ON: Reverse)
2	Reverse/Stop	Reverse rotation command (2-wire sequence) (ON: Reverse)
3	External fault (NO)	ON: External fault
4	External fault (NC)	OFF: External fault
5	Fault reset	ON: Fault reset Note Disabled while RUN command is input
6	Multi-step speed reference 1	Signals to select frequency references 1 to 8.
7	Multi-step speed reference 2	
8	Multi-step speed reference 3	
10	Inching frequency command	ON: Inching frequency command
11	Acceleration/Deceleration time selection	ON: Acceleration/deceleration time 2
12	External base block command (NO)	ON: Output shut OFF (while motor coasting to a stop and "bb" flashing)
13	External base block command (NC)	OFF: Output shut OFF (with motor free running and "bb" flashing)
14	Search command (Searching starts from maximum frequency)	ON: Speed search (Searching starts from n09)

Function of Each Parameter

15	Search command (Searching starts from preset frequency)	ON: Speed search (Searching starts from the frequency specified by n03.)
16	Acceleration/Deceleration-prohibit command	ON: Acceleration/Deceleration is on hold
17	Local or remote selection	ON: Local mode (operated with the Digital Operator)
19	Emergency stop fault (NO)	The Inverter stops according to the setting in n04 for interruption mode selection when the emergency stop input turns ON.
20	Emergency stop alarm (NO)	Note NO: Emergency stop with the contact closed. NC: Emergency stop with the contact opened.
21	Emergency stop fault (NC)	Note Fault: Fault output is ON and reset with RESET input. Alarm output is ON (no reset required).
22	Emergency stop alarm (NC)	Note "STP" is displayed (lit with fault input ON and flashes with alarm input ON)
34	Up or down command	Up or down command (set in n39 only) This setting overrides the n38 setting. S4: Up command S5: Down command

Multi-function Output Selection (n40)

Select the functions of multi-function output terminals.

Value	Name	Setting range	Unit of setting	Default settings
n40	Multi-function Output (MA/MB and MC)	0 to 7, 10 to 17	1	1

Value	Function	Description
0	Fault output	ON: Fault output
1	Operation in progress	ON: Operation in progress
2	Frequency detection	ON: Frequency detection
3	Idling	ON: Idling
4	Frequency detection 1	ON: Output frequency \geq frequency detection level (n58)
5	Frequency detection 2	ON: Output frequency \leq frequency detection level (n58)
6	Overtorque being monitored (NO-contact output)	Output if any of the following parameter conditions is satisfied. • Overtorque detection function selection (n59) • Overtorque detection level (n60)
7	Overtorque being monitored (NC-contact output)	• Overtorque detection time (n61) Note NO contact: ON with overtorque being detected; NC contact: OFF with overtorque being detected
8	(Not used)	---
9		
10	Alarm output	ON: Alarm being detected (Nonfatal error)
11	Base block in progress	ON: Base block in progress
12	RUN mode	ON: Local mode
13	Inverter ready	ON: Inverter ready to operate
14	Fault retry	ON: Fault retry
15	UV in progress	ON: Undervoltage being monitored (main circuit undervoltage UV or UV1 detected)

16	Rotating in reverse direction	ON: Rotating in reverse direction
17	Speed search in progress	ON: Speed search in progress

Gain and Bias Settings (n41 and n42)

Set the input characteristics of analog frequency references in n41 (for the frequency reference gain) and n42 (for the frequency reference bias).

Set the frequency of maximum analog input (10 V or 20 mA) in n41 as percentage based on the maximum frequency as 100%.

Set the frequency of minimum analog input (0 V, 0 mA, or 4 mA) in n42 as percentage based on the maximum frequency as 100%.

Value	Name	Setting range	Unit of setting	Default settings
n41	Frequency Reference Gain	0 to 255	1%	100
n42	Frequency Reference Bias	-99 to 99	1%	0

Analog Frequency Reference Filter Time Setting (n43)

The digital filter with a first-order lag can be set for analog frequency references to be input.

Value	Name	Setting range	Unit of setting	Default settings
n43	Analog Frequency Reference Filter Time	0.00 to 2.00	0.01 s	0.10

Analog Monitor Output Setting (n44)

Set a monitored item for analog monitor output.

Value	Description
0	Output frequency (Reference: 10 V at max. frequency)
1	Output current (Reference: 10 V with rated output current)

Note: The values in parentheses are applicable when n45 is set to 1.00.

Analog Monitor Output Gain Setting (n45)

Set the output characteristics of analog monitor output.

Value	Name	Setting range	Unit of setting	Default settings
n45	Analog Monitor Output Gain	0.00 to 2.00	0.01	1.00

Function of Each Parameter

Carrier Frequency Selection (n46)

Set the carrier frequency.

Value	Description
1	2.5 kHz
2	5.0 kHz
3	7.5 kHz
4	10.0 kHz
7	2.5 kHz (12x): 12 times as high as output frequency (between 1.0 and 2.5 kHz)
8	2.5 kHz (24x): 24 times as high as output frequency (between 1.0 and 2.5 kHz)
9	2.5 kHz (36x): 36 times as high as output frequency (between 1.0 and 2.5 kHz)

Note: Normally, the factory setting need not be changed.

Momentary Power Interruption Compensation (n47)

The parameter specifies the processing that will be performed when a momentary power interruption occurs.

Value	Description
0	Disabled.
1	The Inverter will continue operating if power is restored within 0.5 s.
2	The Inverter will restart when power is restored.

Fault Retry (n48)

Set the number of times the Inverter is to be automatically reset and restarted when the Inverter has an overvoltage fault, over-current fault, or ground fault.

Value	Name	Setting range	Unit of setting	Default settings
n48	Fault Retry	0 to 10	1	0

Frequency Jump Function (n49 to n51)

Set the frequency jump function.

Value	Name	Setting range	Unit of setting	Default settings
n49	Jump Frequency 1	0.0 to 400	0.1 Hz (see note 1)	0.0
n50	Jump Frequency 2	0.0 to 400	0.1 Hz (see note 1)	0.0
n51	Jump Width	0.0 to 25.5	0.1 Hz	0.0

- Note:**
- Values will be set in 0.1-Hz increments if the frequency is less than 100 Hz and 1 Hz-increments if the frequency is 100 Hz or greater.
 - Make settings so that $n49 \geq n50$.

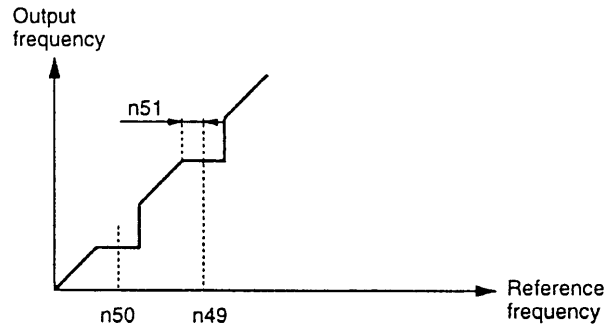

DC Control Functions (n52 to n54)

Used to impose DC on the induction motor for braking control.

Value	Name	Setting range	Unit of setting	Default settings
n52	DC Control Current	0 to 100	1%	50
n53	Interruption DC Control Time	0.0 to 25.5	0.1 s	0.5
n54	Startup DC Control Time	0.0 to 25.5	0.1 s	0.0

DC Control Current:

Set this value in percentage based on the rated output current of the Inverter as 100%.

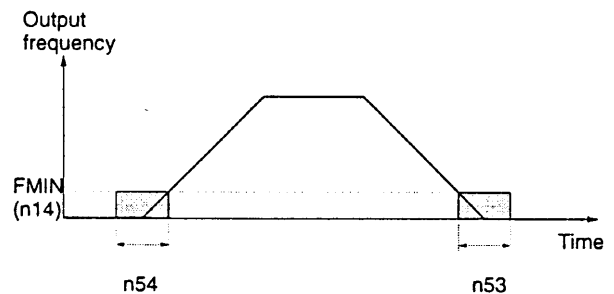

Stall Prevention during Deceleration (n55)

Select a function to change the deceleration time of the motor automatically so that there will be no overvoltage imposed on the motor during deceleration.

Value	Description
0	Stall prevention during deceleration
1	No stall prevention during deceleration

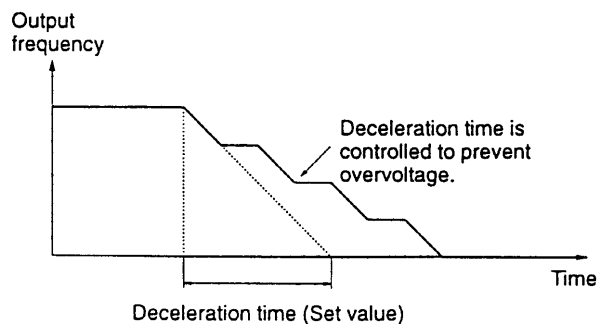

Function of Each Parameter

Stall Prevention Level during Acceleration (n56)

Set the operation level of a function to stop the acceleration of the motor automatically for stall prevention during acceleration. Set this value in percentage based on the rated output current of the Inverter as 100%.

Value	Name	Setting range	Unit of setting	Default settings
n56	Stall Prevention Level during Acceleration	30 to 200	1%	170

Stall Prevention during Acceleration

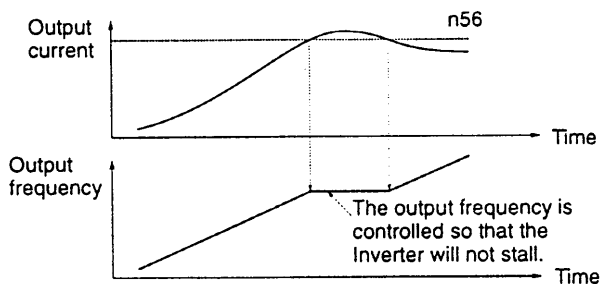

Stall Prevention Level during Operation (n57)

Select the operation level of a function to reduce the output frequency of the Inverter automatically for stall prevention during operation. Set this value in percentage based on the rated output current of the Inverter as 100%.

Value	Name	Setting range	Unit of setting	Default settings
n57	Stall Prevention Level during Operation	30 to 200	1%	160

Stall Prevention during Operation

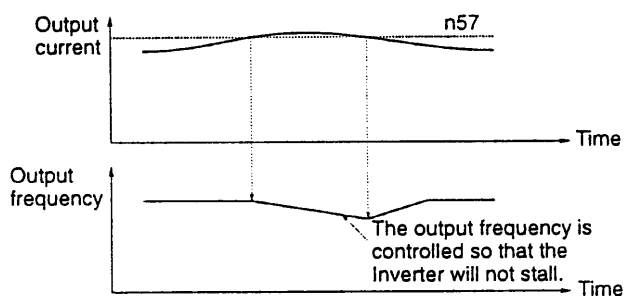

Frequency Detection Level (n58)

Set the frequency to be detected.

Note: When frequency detection 1 and 2 are to be output, n40 (multi-function output) must be set.

Value	Name	Setting range	Unit of setting	Default settings
n58	Frequency Detection Level	0.0 to 400	0.1 Hz	0.0

Overtorque Detection Function Selection (n59 to n61)

Set n59 to enable or disable overtorque detection and select the processing to be performed after overtorque detection.

Value	Description
0	Inverter does not monitor overtorque.
1	Inverter monitors overtorque only when speed is matched. It continues operation (issues warning) even after overtorque is detected.
2	Inverter monitors overtorque only when speed is matched. It discontinues operation (through protective function) when overtorque is detected.
3	Inverter always monitors overtorque during operation. It continues operation (issues warning) even after overtorque is detected.
4	Inverter always monitors overtorque during operation. It discontinues operation (through protective function) when overtorque is detected.

Set the overtorque detection level in n60 and the overtorque detection time in n61.

Value	Name	Setting range	Unit of setting	Default settings
n60	Overtorque Detection Level	30 to 200	1%	160
n61	Overtorque Detection Time	0.1 to 10.0	0.1 s	0.1

Note: 1. In n60, set the overtorque detection level in percentage based on the rated output current of the Inverter as 100%.
2. In n61, set the overtorque detection time in 0.1-s increments.

Overtorque Detection

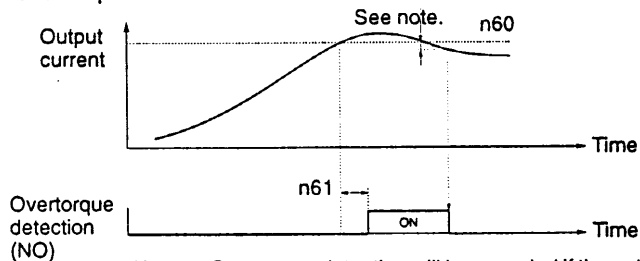

Note: Overtorque detection will be canceled if the output current decreases from the detection level by approximately 5% of the Inverter rated current.

Function of Each Parameter

UP/DOWN Command Frequency Memory Selection (n62)

Select whether to store the frequency reference adjusted with the UP/DOWN function.

Value	Description
0	The frequency on hold is not retained.
1	The frequency on hold for 5 s or more is retained.

The UP/DOWN function uses UP and DOWN commands to change frequency references.

When using the UP/DOWN function, set multi-function input 4 (n39) to 34 (UP or DOWN command). The terminals for multi-function input 3 (S4) and multi-function input 4 (S5) will be set to function in the following way:

Multiple-function input 3 (S4): UP command
Multiple-function input 4 (S5): DOWN command

Use n62 (UP/DOWN command frequency memory) to set whether the frequency reference on hold is stored or not when an UP or DOWN command is sent to the multi-function input terminals.

If n62 is set to 1, the output frequency held by the UP/DOWN function for 5 s or more will be stored in the memory. This value will be stored in memory even if power is interrupted. When a RESET command is input, operation will start with this value as the frequency.

If n62 is set to 0, the frequency will be cleared. If parameter initialization is performed (i.e.: n01 is set to 8 or 9), the stored frequency will be initialized.

Note: If the UP/DOWN function is used in remote mode, frequency references can only be given with UP/DOWN commands and inching commands. Multi-step speed references will be invalid.

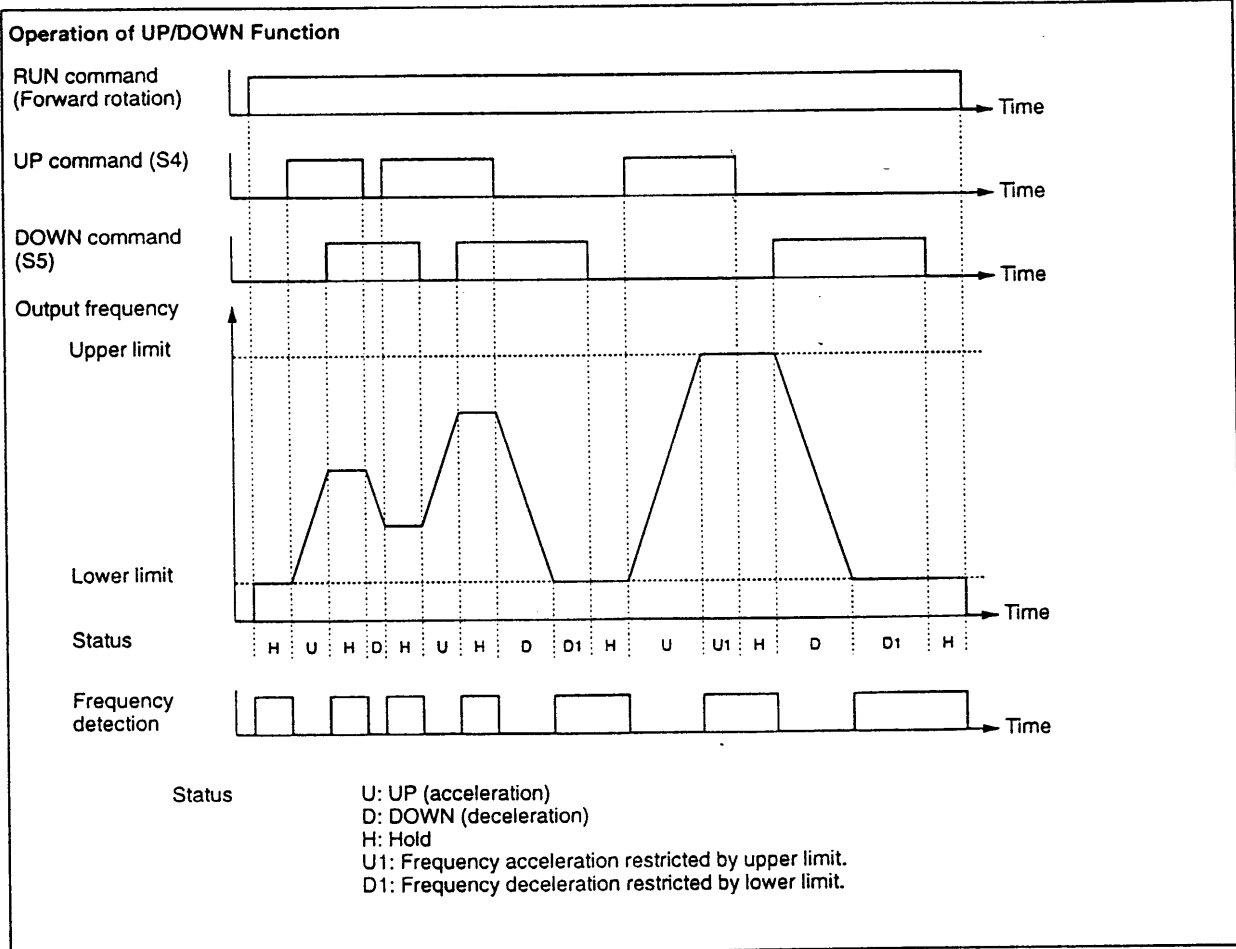

Function of Each Parameter

Torque Compensation Gain (n63)

Set the gain of the torque compensation function.

Note: Normally, the factory setting need not be changed.

Value	Name	Setting range	Unit of setting	Default settings
n63	Torque Compensation Gain	0.0 to 2.5	0.1	1.0

Slip Compensation Functions (n64 to n67)

In n64, set the rated slip value of the motor in use.

In n65, set the no-load current of the motor in use based on the rated motor current as 100%.

In n66, set the gain of the slip compensation function.

In n67, set the response speed of the slip compensation function.

Value	Name	Setting range	Unit of setting	Default settings
n64	Motor Rated Slip	0.0 to 20.0	0.1 Hz	Varies with the capacity.
n65	Motor No-load Current	0 to 99	1%	
n66	Slip Compensation Gain	0.0 to 2.5	0.1	0.0
n67	Slip Compensation Time Constant	0.0 to 25.5	0.1 s	2.0

Note: If 0.0 is set for n66, the slip compensation function will be disabled.

Specifications

■ Specifications

3-phase 200-V AC models	Model 3G3JV-		A2001	A2002	A2004	A2007	A2015	A2022	
	Power supply	Rated voltage and frequency	3-phase 200 to 230 V AC at 50/60 Hz						
		Allowable voltage fluctuation	-15% to 10%						
		Allowable frequency fluctuation	±5%						
	Heat radiation (W)		13.0	18.0	28.1	45.1	72.8	94.8	
	Weight (kg)		0.5	0.5	0.8	0.9	1.3	1.5	
Cooling method		Natural cooling				Cooling fan			

Single-phase 200-V AC models	Model 3G3JV-		AB001	AB002	AB004	AB007	AB015	--	
	Power supply	Rated voltage and frequency	Single-phase 200 to 240 V AC at 50/60 Hz						
		Allowable voltage fluctuation	-15% to 10%						
		Allowable frequency fluctuation	±5%						
	Heat radiation (W)		14.1	20.0	31.9	51.4	82.8	---	
	Weight (kg)		0.5	0.5	0.9	1.5	1.5	---	
Cooling method		Natural cooling				Cooling fan			

Max. applicable motor capacity (kW)		0.1	0.2	0.4	0.75	1.5	2.2
Output specifications	Rated output capacity (kW)	0.3	0.6	1.1	1.9	3.0	4.2
	Rated output current (A)	0.8	1.6	3.0	5.0	8.0	11.0
	Rated output voltage (V)	3-phase 200 to 230 V AC (according to the input voltage)					
	Max. output frequency	400 Hz parameter setting					
Control characteristics	Harmonic-current countermeasures	DC reactor (option) connection possible					
	Control method	Sine wave PWM (V/f control)					
	Carrier frequency	2.5 to 10.0 kHz (in vector control)					
	Frequency control range	0.1 to 400 Hz					
	Frequency precision (temperature characteristics)	Digital commands: ±0.01% (-10°C to 50°C) Analog commands: ±0.5% (25°C ± 10°C)					
	Frequency setting resolution	Digital commands: 0.1 Hz (less than 100 Hz) and 1 Hz (100 Hz or over) Analog commands: 0.06 Hz/60 Hz (equivalent to 1/1000)					
	Output frequency resolution	0.01 Hz (calculated resolution)					
	Overload capacity	150% of rated output current for 1 min					
	External frequency set signal	Selectable with FREQ adjuster: 0 to 10 V DC (20 kΩ), 4 to 20 mA (250 Ω), and 0 to 20 mA (250 Ω)					
	Acceleration/deceleration time	0.0 to 999 s (Independent acceleration and deceleration time settings)					
Braking torque	Approx. 20%						
Voltage/frequency characteristics	Set a user V/f pattern						
Protective functions	Motor protection	Protection by electronic thermal					
	Instantaneous overcurrent protection	Stops at approx. 250% of rated output current					
	Overload protection	Stops in 1 min at approximately 150% of rated output current					
	Overvoltage protection	Stops when main-circuit DC voltage is approximately 410 V					
	Undervoltage protection	Stops when main-circuit DC voltage is approximately 200 V (180 V for single-phase 200-V AC model)					
	Momentary power interruption compensation (selection)	Stops for 15 ms or more. By setting the Inverter to momentary power interruption mode, operation can be continued if power is restored within approximately 0.5 s.					
	Cooling fin overheating	Detects at 110°C ± 10°C					
	Grounding protection	Protection at rated output current level					
Charge indicator (RUN indicator)	Lit when the main circuit DC voltage is approximately 50 V or less.						
Environment	Location	Indoors (with no corrosive gas, oil spray, or metallic dust)					
	Ambient temperature	Operating: -10°C to 50°C					
	Ambient humidity	Operating: 95% max. (with no condensation)					
	Ambient temperature	-20°C to 60°C					
	Altitude	1,000 m max.					
	Insulation resistance	5 MΩ min. (Do not carry out any insulation resistance or withstand voltage tests)					
Vibration resistance	9.8 m/s ² max. between 10 to 20 Hz 2.0 m/s ² max. between 20 and 50 Hz						
Degree of protection	Panel-mounting models: Conforms to IP20						

■ Terminal Block

Position of Terminal Block

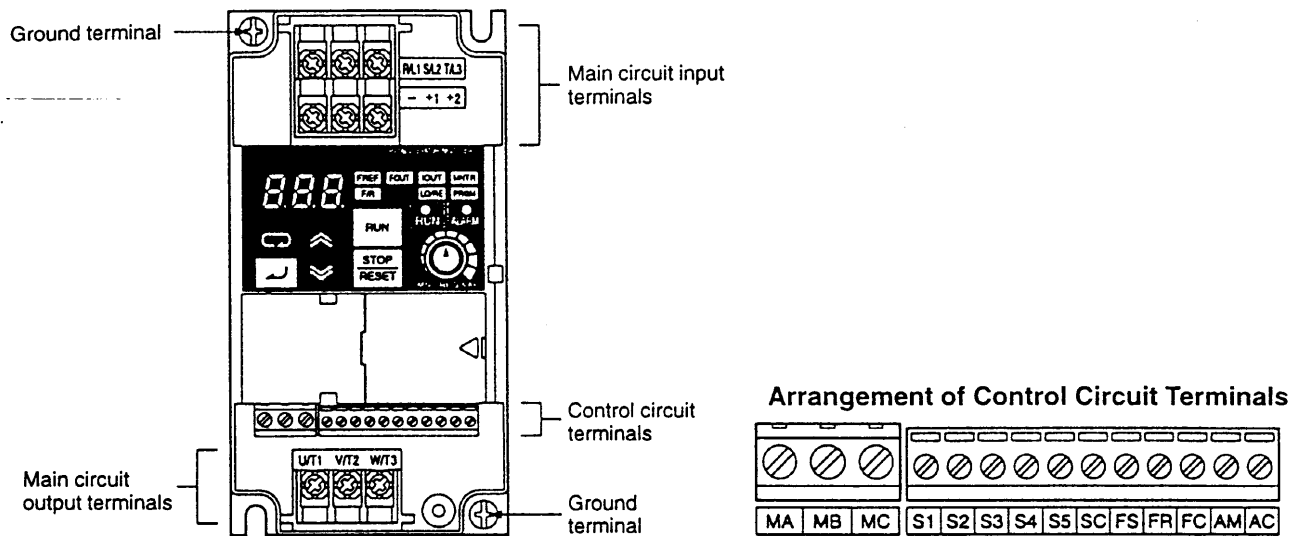

Note: This illustration shows the terminal block with the front cover removed.

Main Circuit Terminals

Symbol	Name	Description
R/L1	Power supply input terminals	3G3JV-A2□: 3-phase 200 to 230 V AC 3G3JV-AB□: Single-phase 200 to 240 V AC Note Connect single-phase input to terminals R/L1 and S/L2.
S/L2		
T/L3		
U/T1	Motor output terminals	3-phase power supply output for driving motors. 3G3JV-A2□, 3G3JV-AB□: 3-phase 200 to 230 V AC Note The maximum output voltage corresponds to the input power supply voltage for the Inverter.
V/T2		
W/T3		
+1	Connection terminals +1 and +2: DC reactor connection terminals +1 and -: DC power supply input terminals	Connect the DC reactor for suppressing harmonics to terminals +1 and +2. When driving the Inverter with DC power, input the DC power to terminals +1 and -. (Terminal +1 is a positive terminal.)
+2		
-		
	Ground terminal	Be sure to ground the terminal under the following conditions. 3G3JV-A2□: Ground at a resistance of 100 Ω or less. 3G3JV-AB□: Ground at a resistance of 100 Ω or less. Note Be sure to connect the ground terminal directly to the motor frame ground.

Specifications

Control Circuit Terminals

Symbol	Name	Function	Signal level	
Input	S1	Forward/Stop	Photocoupler 8 mA at 24 V DC	
	S2	Multi-function input 1 (S2)		Forward at ON. Stops at OFF.
	S3	Multi-function input 2 (S3)		Set by parameter n36 (Reverse/Stop)
	S4	Multi-function input 3 (S4)		Set by parameter n37 (External fault: Normally open)
	S5	Multi-function input 4 (S5)		Set by parameter n38 (Fault reset)
	SC	Sequence input common		Set by parameter n39 (Multi-step reference 1)
	FS	Frequency reference power supply	Common for S1 through S5	DC power supply for frequency reference use
	FR	Frequency reference input	Input terminal for frequency reference use	20 mA at 12 V DC
	FC	Frequency reference common	Common for frequency reference use	0 to 10 V DC (20 k Ω)
Output	MA	Multi-function contact output (Normally open)	Relay output 1 A max. at 30 V DC 1 A max. at 250 V AC	
	MB	Multi-function contact output (Normally closed)		
	MC	Multi-function contact output common		Common for MA and MB use
	AM	Analog monitor output	Set by parameter n44 (Output frequency)	2 mA max. at 0 to 10 V DC
	AC	Analog monitor output common	Common for AM use	

Note: Functions in parentheses are default settings.

Dimensions

■ Dimensions

3G3JV-A2001 to 3G3JV-A2007 (0.1 to 0.75 kW)
3-phase 200-V AC Input

3G3JV-AB001 to 3G3JV-AB004 (0.1 to 0.4 kW)
Single-phase 200-V AC Input

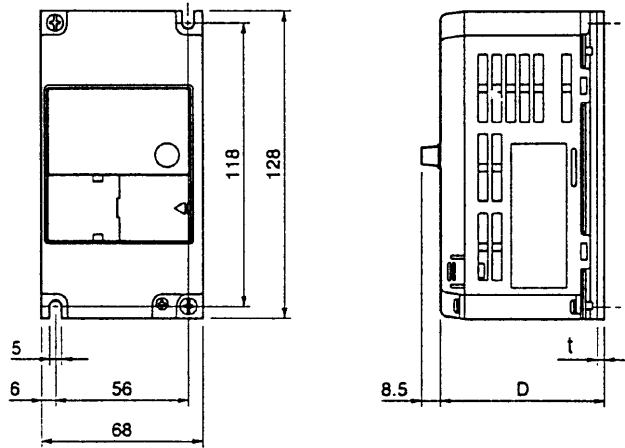

3G3JV-A2015 to 3G3JV-A2022 (1.5 to 2.2 kW)
3-phase 200-V AC Input

3G3JV-AB007 to 3G3JV-AB015 (0.75 to 1.5 kW)
Single-phase 200-V AC Input

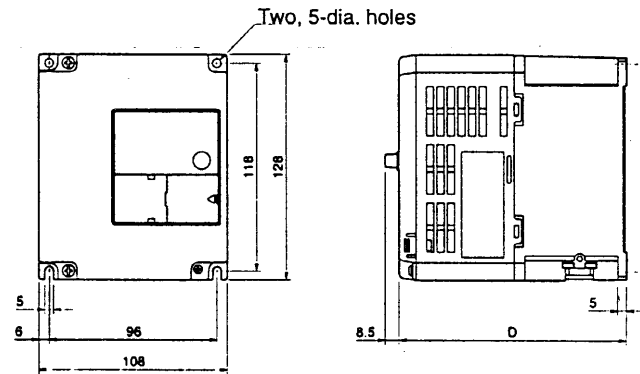

Rated voltage	Model 3G3JV-	Dimen- sions (mm)		Weight (kg)
		D	t	
3-phase 200 V AC	A2001	70	3	Approx. 0.5
	A2002	70	3	Approx. 0.5
	A2004	102	5	Approx. 0.8
	A2007	122	5	Approx. 0.9
Single-phase 200 V AC	AB001	70	3	Approx. 0.5
	AB002	70	3	Approx. 0.5
	AB004	112	5	Approx. 0.9

Rated voltage	Model 3G3JV-	Dimen- sions (mm)	Weight (kg)
		D	
3-phase 200 V AC	A2015	129	Approx. 1.3
	A2022	154	Approx. 1.5
Single-phase 200 V AC	AB007	129	Approx. 1.5
	AB015	154	Approx. 1.5

Standard Connections

Standard Connections

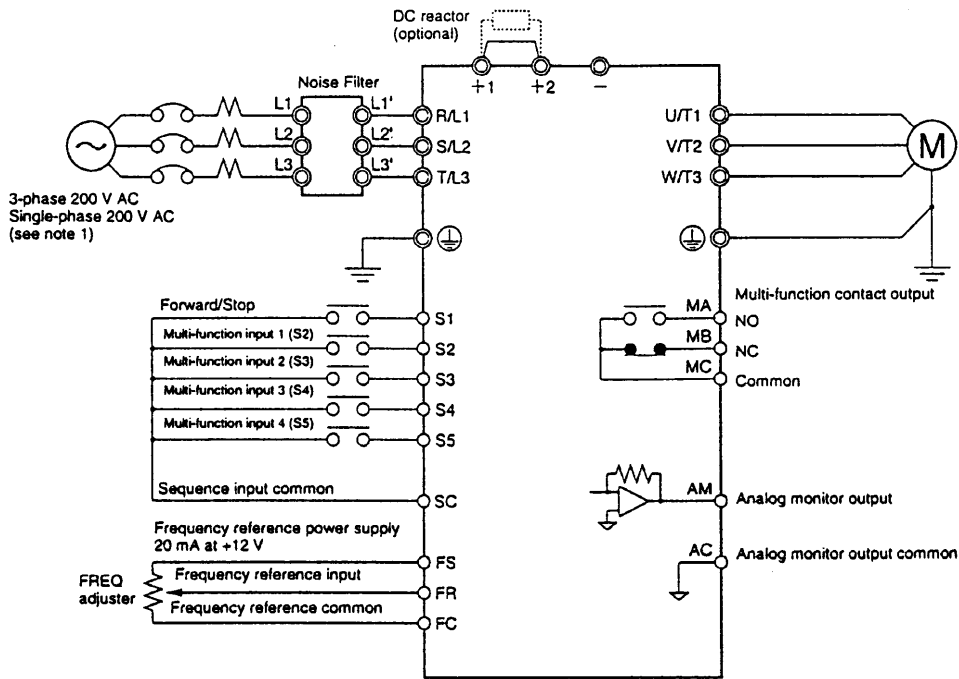

- Note:** 1. Connect single-phase 200 V AC to terminals R/L1 and S/L2 of the 3G3JV-AB□.
 2. The braking resistor cannot be connected because no braking transistor is incorporated.

Input Method Selection

Switches SW7 and SW8, both of which are located above the control circuit terminals, are used for input method selection. Remove the front cover and optional cover to use these switches.

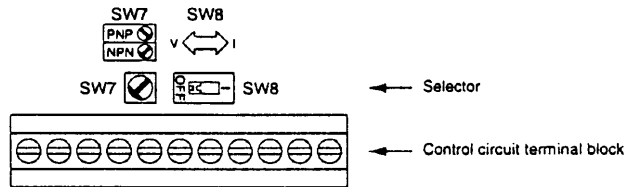

Sequence Input Method Selection

By using SW7, NPN or PNP input can be selected as shown below.

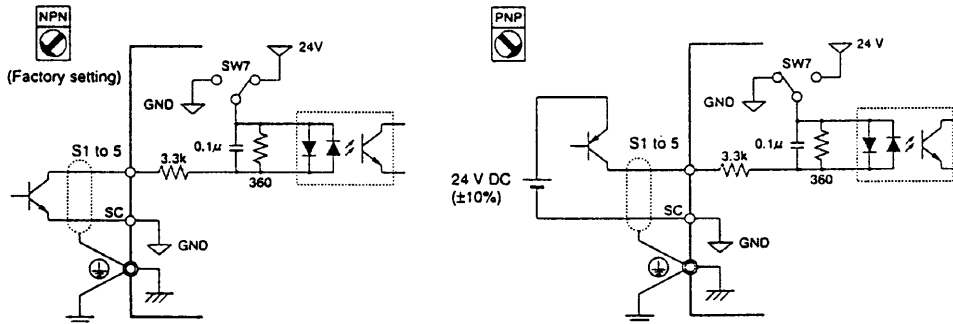

Frequency Reference Input Method Selection

By using SW8, frequency reference voltage or current input can be selected. Parameter settings are required together with the selection of the frequency reference input method.

Frequency reference input method	SW8 setting	Frequency reference selection (parameter n03)
Voltage input	V (OFF)	Set value 2
Current input	I (ON)	Set value 3 or 4

Overview of Options

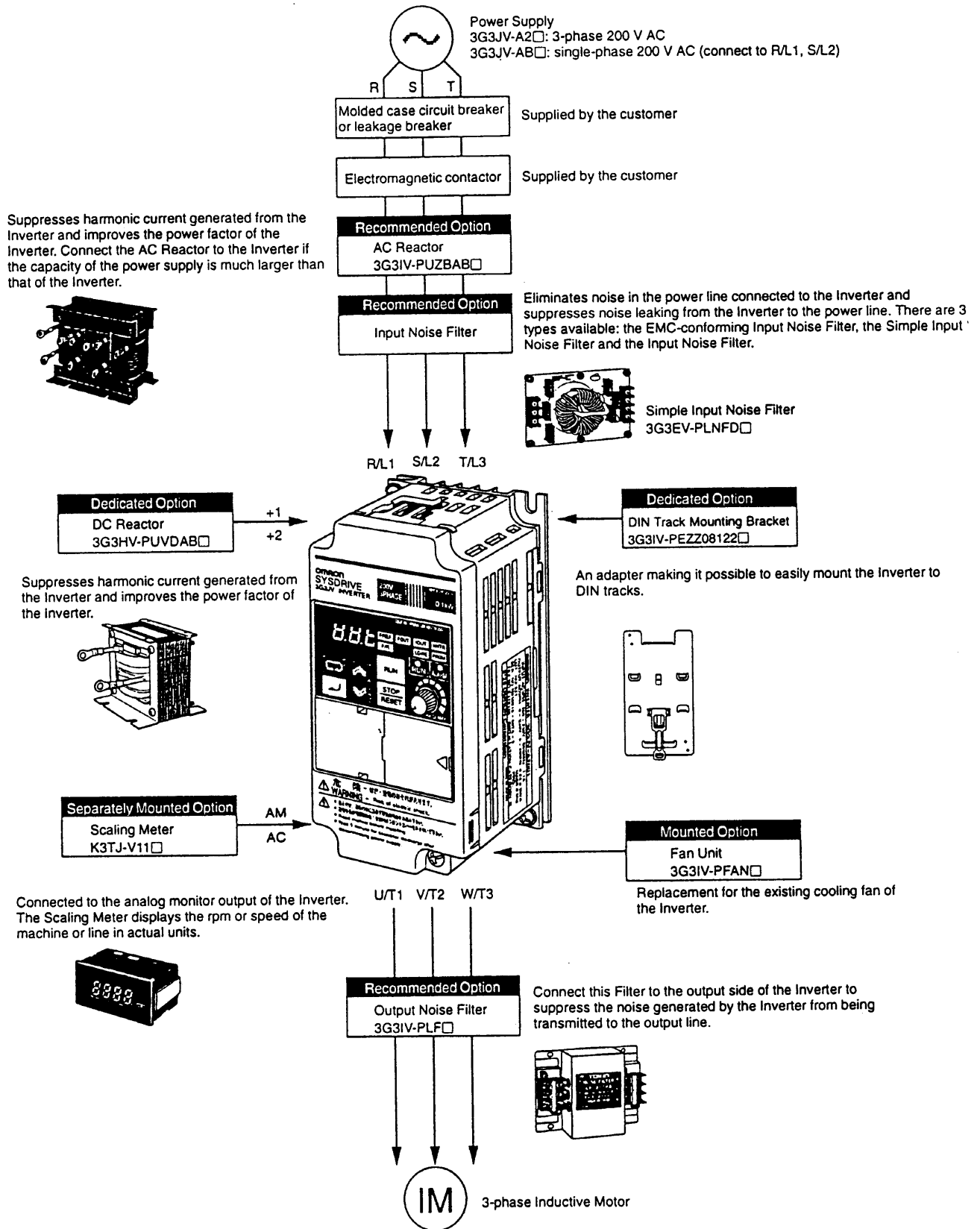

Options

Mounted Option

Name	Model	Description	Reference page
Fan Unit	3G3IV-PFAN□	Replacement for the existing cooling fan of the Inverter. Replace the cooling fan if it has reached the end of its service life or a warning of cooling fan failure (FAN) is indicated.	29

Separately Mounted Option

Name	Model	Description	Reference page
Scaling Meter	K3TJ-V11□	Connected to the analog monitor output of the Inverter. The Scaling Meter displays the rpm or speed of the machine or line in actual units.	29

Dedicated Options

Name	Model	Description	Reference page
DC Reactor	3G3HV-PUVDAB□	Suppresses harmonic current generated from the Inverter and improves the power factor of the Inverter.	30
DIN Track Mounting Bracket	3G3IV-PEZZ08122□	An adapter making it possible to easily mount the Inverter to DIN tracks.	30

Recommended Options

Name	Model	Description	Reference page
AC Reactor (Yaskawa Electric)	3G3IV-PUZBAB□	Suppresses harmonic current generated from the Inverter and improves the power factor of the Inverter. Connect the AC Reactor to the Inverter if the capacity of the power supply is much larger than that of the Inverter.	31
EMC-conforming Input Noise Filter (Rasmi)	3G3IV-PRS□	A Noise Filter on the input side meeting the EC Directive's EMC requirements.	32
Simple Input Noise Filter (Yaskawa Electric)	3G3EV-PLNFD□	Each of these Filters connected to the power input side eliminates noise in the power line connected to the Inverter and suppresses noise leaking from the Inverter to the power line.	33
Input Noise Filter (Soshin Electric)	3G3IV-PHF□		34
Output Noise Filter (Tokin)	3G3IV-PLF□	Connect this Filter to the output side of the Inverter to suppress the noise generated by the Inverter from being transmitted to the output line.	35

■ Fan Unit

3G3IV-PFAN□

The Fan Unit is a replacement for the presently installed cooling fan of the Inverter. Replace the cooling fan if it has reached the end of its service life or a warning of cooling fan failure (FAN) is indicated.

Inverter		Fan Unit
3-phase 200 V AC	3G3JV-A2007	3G3IV-PFAN2007
	3G3JV-A2015/-A2022	3G3IV-PFAN2015J
Single-phase 200 V AC	3G3JV-AB015	3G3IV-PFAN2015J

■ Scaling Meter

K3TJ-V11□

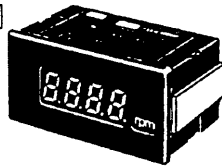

The Scaling Meter is connected to the analog monitor output of the Inverter so that the Scaling Meter will display the rpm and speed values of the machines and lines in actual units.

Applicable Models

Model	Control power supply	Indicator
K3TJ-V111R	100 to 200 V AC	Red LED
K3TJ-V111G		Green LED
K3TJ-V116R	24 V DC insulated construction (see note)	Red LED
K3TJ-V116G		Green LED

Note: The power supply circuit and input circuit are insulated from each other.

Standard Specifications

Sampling cycle	2 times/s
Display refresh cycle	2 times/s
Average processing method	Simple or continuous average processing
Number of average processing times	1, 2, 4, or 8
Max. number of display digits	4 (-1,999 to 9,999)
Indicator	14.2-mm height, 7-segment LED
Decimal point display	Parameter selector or Up and Down Keys
Scaling method	Parameter selector or Up and Down Keys for shifting and scaling adjustments
Scaling range	-1,999 to +9,999
Zero-limit range	0 to 99 digits
Over range	Flashing
Zero suppress	Available
External control	Present value hold (with rear terminals shorted)
Degree of protection (conforming to IEC)	Front panel: IP51 (see note) Casing: IP20 Terminals: IP00
Memory protection	Nonvolatile memory

Note: The front panel ensures IP50, but the front panel with the K32-L493C Drip-proof Cover ensures IP51.

Wiring Example

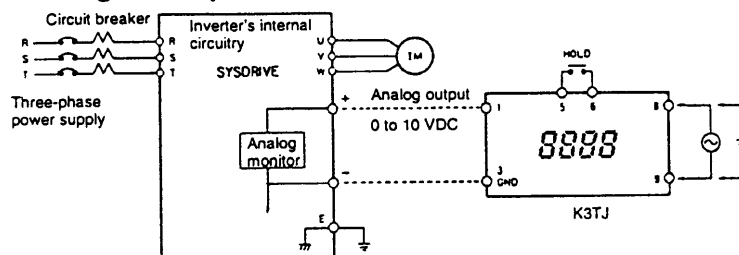

External Dimensions (mm)

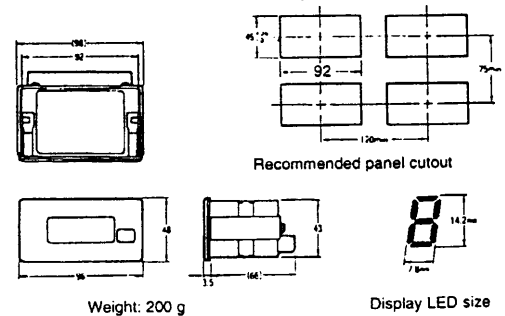

Options

■ DC Reactor

3G3HV-PUZDAB□

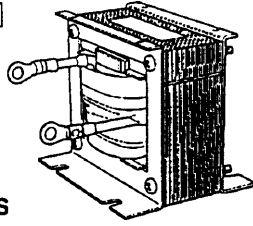

The DC Reactor suppresses harmonic current generated from the Inverter and improves the power factor of the Inverter. The DC Reactor suppresses harmonic current more effectively than the AC Reactor. Furthermore, the DC Reactor can be used in combination with the AC Reactor. Used with either 3-phase or single-phase 200-V AC Inverters.

Applicable Models

Inverter		DC Reactor			
Voltage class	Max. applicable motor capacity (kW)	Model	Rated voltage (V)	Rated current (A)	Inductance (mH)
200 V	0.1 to 0.75	3G3HV-PUZDAB5.4A8MH	800 V DC	5.4	8
	1.5 to 2.2	3G3HV-PUZDAB18A3MH		18	3

External Dimensions (mm)

External Dimensions 1

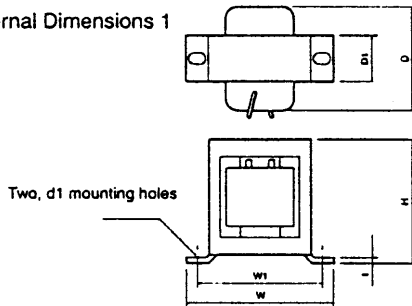

External Dimensions 2

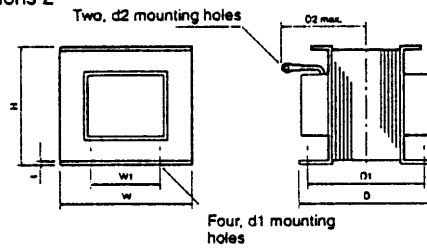

Model 3G3HV-PUZDAB□	External dimensions	Dimension (mm)									Weight (kg)
		H	W	W1	D	D1	D2	t	d1	d2	
5.4A8MH	1	53	85	74	60	32	---	0.8	M4	---	0.8
18A3MH	2	76	86	60	72	55	80	1.2	M4	M5	2.0

■ DIN Track Mounting Bracket

3G3IV-PEZZ08122□

An adapter making it possible to easily mount the Inverter to DIN tracks.

Applicable Models

Inverter	DIN Track Mounting Bracket
3-phase 200 V AC	3G3IV-PEZZ08122A
	3G3IV-PEZZ08122B
Single-phase 200 V AC	3G3IV-PEZZ08122A
	3G3IV-PEZZ08122B

External Dimensions (mm)

3G3IV-PEZZ08122A

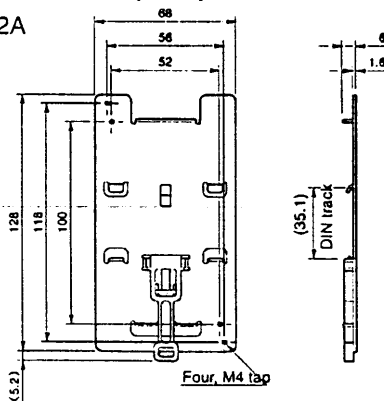

3G3IV-PEZZ08122B

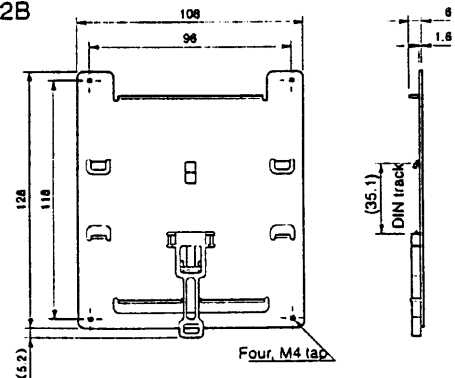

■ AC Reactor

3G3IV-PUZBAB□ (Yaskawa Electric)

The AC Reactor suppresses harmonic current generated from the Inverter and improves the power factor of the Inverter. Connect the AC Reactor to the Inverter if the capacity of the power supply is much larger than that of the Inverter. Select the AC Reactor model from the following table according to the motor capacity.

Note: The AC Reactor can be used with either 3-phase or single-phase 200-V AC Inverters.

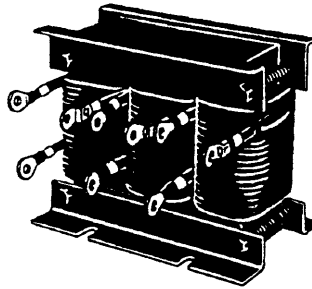

Connection Example

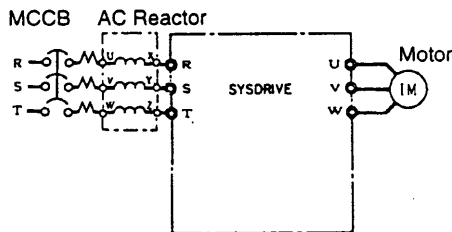

Applicable Range

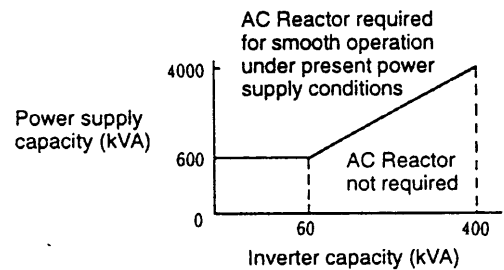

Applicable Models and Dimensions

200-V Class

Max. applicable motor capacity (kW)	Model 3G3IV-PUZBAB□	Current (A)	Inductance (mH)	Loss (W)	Weight (kg)	Dimension (mm)										
						A	B	C	D	E	F	H	J	K	L	M
0.1 to 0.2	2A7.0MH	2	7.0	8	2.5	120	71	115	40	50	105	20	M6	10.5	7	M4
0.4	2.5A4.2MH	2.5	4.2	15	2.5	120	71	120	40	50	105	20	M6	10.5	7	M4
0.75	5A2.1MH	5	2.1	15	2.5	120	71	120	40	50	105	20	M6	10.5	7	M4
1.5	10A1.1MH	10	1.1	25	3	130	88	130	50	65	130	22	M6	11.5	7	M4
2.2	15A0.71MH	15	0.71	30	3	130	88	130	50	65	130	22	M6	11.5	7	M4

External Dimensions

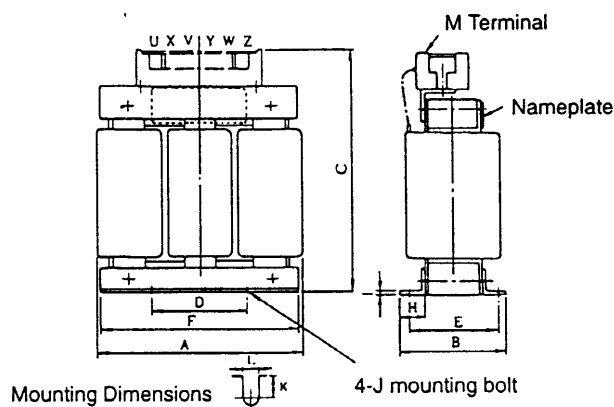

Options

■ EMC-conforming Input Noise Filter

3G3JV-PRS□ (Rasmi)

The Input Noise Filter is connected between the power supply input terminals (R/L1, S/L2, T/L3) of the Inverter and the power supply in order to meet the EC Directive's EMC requirements.

Connection Example

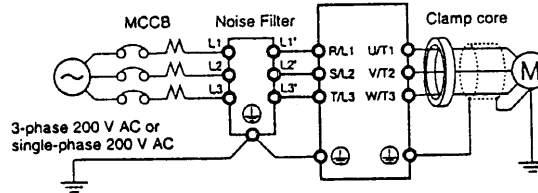

Applicable Models

Inverter		EMC-conforming Input Noise Filter		
Voltage	Model	Model	Rated current (A)	Weight (kg)
3-phase 200 V AC	3G3JV-A2001/-A2002/-A2004/-A2007	3G3JV-PRS2010J	10	0.8
	3G3JV-A2015/-A2022	3G3JV-PRS2020J	16	1.0
Single-phase 200 V AC	3G3JV-AB001/-AB002/-AB004	3G3JV-PRS1010J	10	0.6
	3G3JV-AB007/-AB015	3G3JV-PRS1020J	20	1.0

External Dimensions

3G3JV-PRS2010J

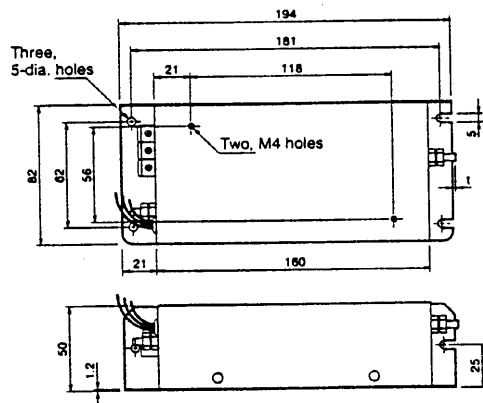

3G3JV-PRS1010J

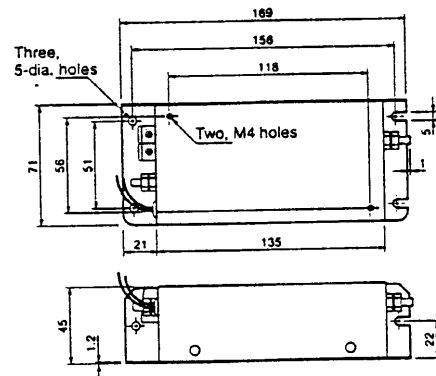

3G3JV-PRS2020J

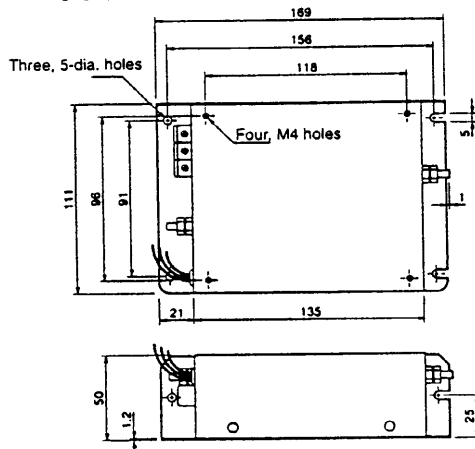

3G3JV-PRS1020J

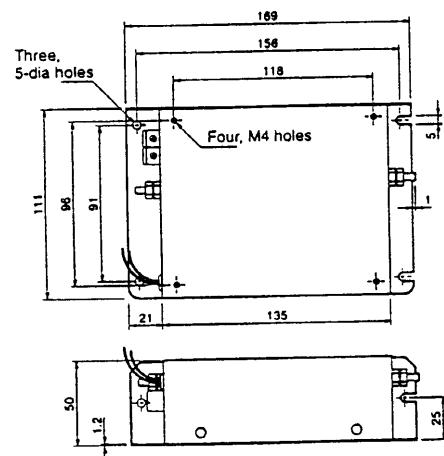

Simple Input Noise Filter

3G3EV-PLNFD□ (Yaskawa Electric)

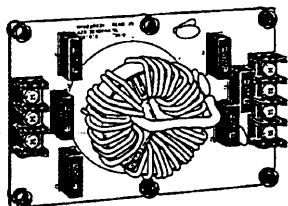

The Simple Input Noise Filter is connected to the power input side to eliminate the noise in the power line connected to the Inverter and suppress noise leaking from the Inverter to the power line.

Applicable Models

Voltage	Inverter		Simple Input Noise Filter		
	Model	Model 3G3EV-	Rated current (A)	Weight (kg)	
3-phase 200 V AC	3G3JV-A2001/-A2002/-A2004/-A2007	PLNFD2103DY	10	0.2	
	3G3JV-A2015	PLNFD2153DY	15	0.2	
	3G3JV-A2022	PLNFD2203DY	20	0.4	
Single-phase 200 V AC	3G3JV-AB001/-AB002	PLNFB2102DY	10	0.1	
	3G3JV-AB004	PLNFB2152DY	15	0.2	
	3G3JV-AB007	PLNFB2202DY	20	0.2	
	3G3JV-AB015	PLNFB2302DY	30	0.3	

Connection Example

3-phase input

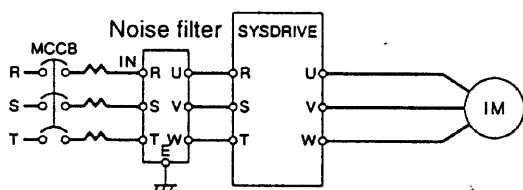

Single-phase input

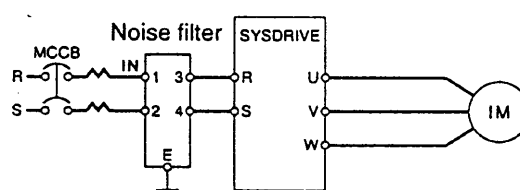

External Dimensions

External Dimensions 1 (Single-phase Input)

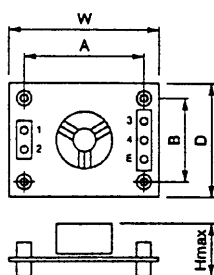

External Dimensions 2 (Three-phase Input)

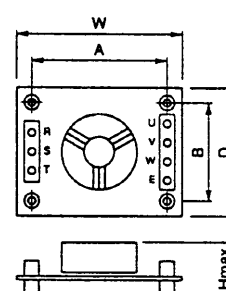

Model 3G3EV-	Dimension	Dimension (mm)					
		W	D	H max.	A	B	Mounting screw
PLNFD2103DY	2	120	80	55	108	68	M4 × 4, 20 mm
PLNFD2153DY		120	80	55	108	68	M4 × 4, 20 mm
PLNFD2203DY		170	90	70	158	78	M4 × 4, 20 mm
PLNFB2102DY	1	120	80	50	108	68	M4 × 4, 20 mm
PLNFB2152DY		120	80	50	108	68	M4 × 4, 20 mm
PLNFB2202DY		120	80	50	108	68	M4 × 4, 20 mm
PLNFB2302DY		130	90	65	118	78	M4 × 4, 20 mm

Options

■ Input Noise Filter (3-phase)

3G3IV-PHF□ (Soshin Electric)

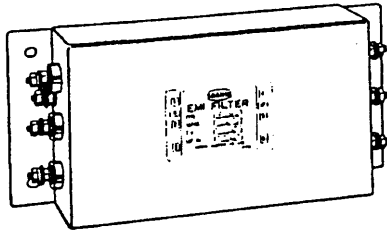

The Input Noise Filter is connected to the power input side to eliminate the noise in the power line connected to the Inverter and suppress noise leaking from the Inverter to the power line.

Note: This Input Noise Filter is for three-phase use only and not available to single-phase input.

Connection Example

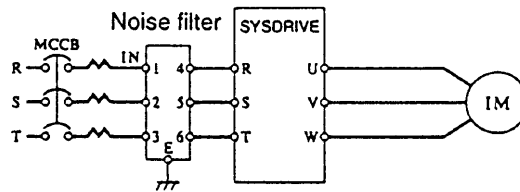

Applicable Models

Inverter			Input Noise Filter	
Voltage class	Max. applicable motor (kW)	Inverter capacity (kVA)	Model	Rated current (A)
200-V class	0.1	0.3	3G3IV-PHF3005AZ	5
	0.2	0.6		
	0.4	1.4		
	0.75	2.1	3G3IV-PHF3010AZ	
	1.5	2.7		
	2.2	4.1		

External Dimensions

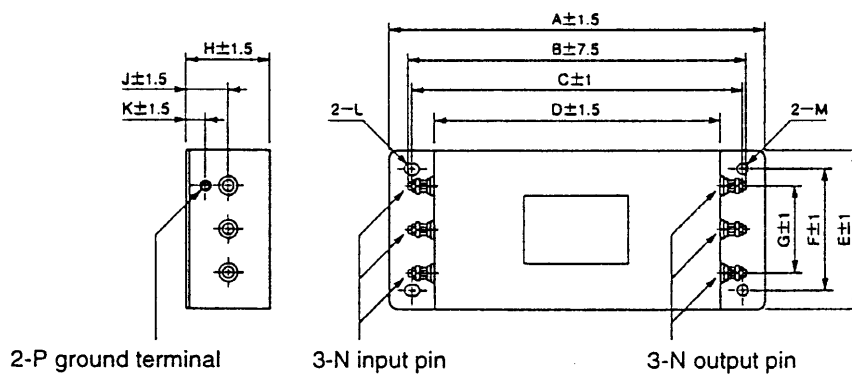

Model 3G3IV-	Dimension (mm)															Weight (kg)
	A	B	C	D	E	F	G	H	J	K	L	M	N	P		
PHF3005AZ	220	208	195	170	95	70	50	50	25	10	Length: 6 R: 2.25	4.5 dia.	M4	M4	1.0	
PHF3010AZ															1.2	
PHF3015AZ															1.3	

■ Output Noise Filter

3G3IV-PLF□ (Tokin)

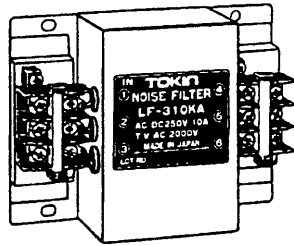

The Output Noise Filter suppresses the generated noise of the Inverter from being transmitted to the output line. Connect the Output Noise Filter to the output side of the Inverter.

Connection Example

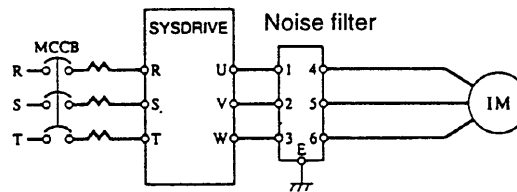

Applicable Models

Inverter			Output Noise Filter	
Voltage class	Max. applicable motor capacity (kW)	Inverter capacity (kVA)	Model	Rated current (A)
200-V class	0.1	0.3	3G3IV-PLF310KA	10
	0.2	0.6		
	0.4	1.4		
	0.75	2.1		
	1.5	2.7		
	2.2	4.1		

External Dimensions

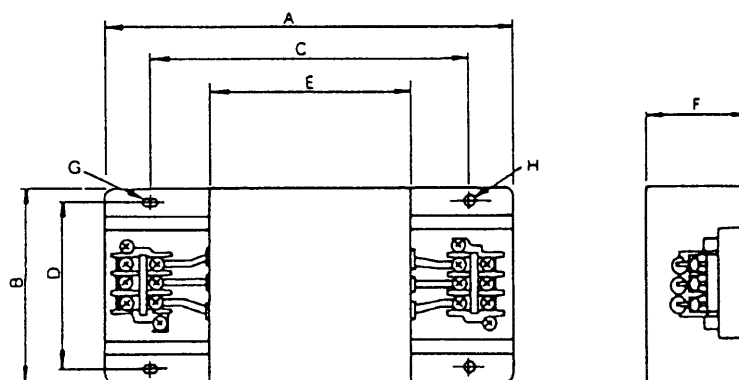

Model 3G3IV-	Dimensions (mm)									Weight (kg)
	Terminal board	A	B	C	D	E	F	G	H	
PLF310KA	TE-K5.5 M4	140	100	100	90	70	45	7 × 4.5 dia.	4.5 dia.	0.5

Inverter Models

■ Inverter Models

Rated voltage	Degree of protection	Max. applicable motor capacity	Model
3-phase 200 V AC	Panel-mounting type (equivalent to IP20)	0.1 kW	3G3JV-A2001
		0.2 kW	3G3JV-A2002
		0.4 kW	3G3JV-A2004
		0.75 kW	3G3JV-A2007
		1.5 kW	3G3JV-A2015
		2.2 kW	3G3JV-A2022
Single-phase 200 V AC	Panel-mounting type (equivalent to IP20)	0.1 kW	3G3JV-AB001
		0.2 kW	3G3JV-AB002
		0.4 kW	3G3JV-AB004
		0.75 kW	3G3JV-AB007
		1.5 kW	3G3JV-AB015

■ Explanation of Product Code

3G3JV-A2007

Series name:
3G3JV Series

Max. applicable motor capacity

001	0.1 kW
002	0.2 kW
004	0.4 kW
007	0.75 kW
015	1.5 kW
022	2.2 kW

Voltage class

2	3-phase 200 V AC (200-V class)
B	Single-phase 200 V AC (200-V class)

Degree of protection

2	Panel-mounting type
---	---------------------