



STU7NB90 STU7NB90I

N-CHANNEL 900V - 1.1 Ω - 7.3 A Max220/Max220I PowerMesh™ MOSFET

TYPE	V _{DSS}	R _{DS(on)}	I _D
STU7NB90	900 V	< 1.45 Ω	7.3 A
STU7NB90I	900 V	< 1.45 Ω	7.3 A

- TYPICAL R_{DS(on)} = 1.1 Ω
- EXTREMELY HIGH dv/dt CAPABILITY
- 100% AVALANCHE TESTED
- VERY LOW INTRINSIC CAPACITANCES
- GATE CHARGE MINIMIZED
- REDUCED VOLTAGE SPREAD

DESCRIPTION

Using the latest high voltage MESH OVERLAY™ process, STMicroelectronics has designed an advanced family of power MOSFETs with outstanding performances. The new patent pending strip layout coupled with the Company's proprietary edge termination structure, gives the lowest R_{DS(on)} per area, exceptional avalanche and dv/dt capabilities and unrivalled gate charge and switching characteristics.

APPLICATIONS

- HIGH CURRENT, HIGH SPEED SWITCHING
- SWITCH MODE POWER SUPPLIES (SMPS)
- DC-AC CONVERTERS FOR WELDING EQUIPMENT

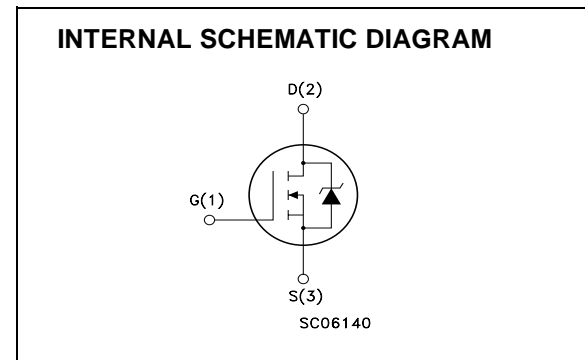
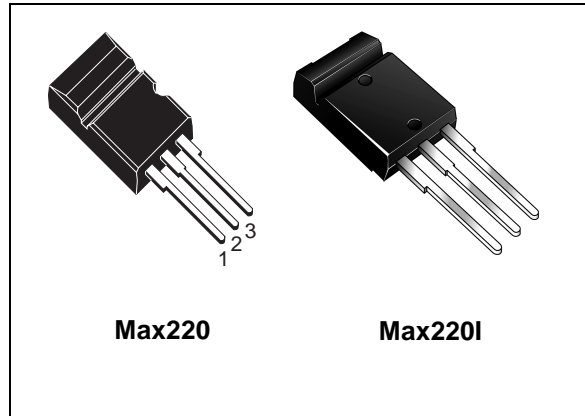

ABSOLUTE MAXIMUM RATINGS

Symbol	Parameter	Value		Unit
		STU7NB90	STU7NB90I	
V _{DS}	Drain-source Voltage (V _{GS} = 0)	900		V
V _{DGR}	Drain-gate Voltage (R _{GS} = 20 k Ω)	900		V
V _{GS}	Gate- source Voltage	±30		V
I _D	Drain Current (continuous) at T _C = 25°C	7.3	7.3 (*)	A
I _D	Drain Current (continuous) at T _C = 100°C	4.6	4.6 (*)	A
I _{DM} (●)	Drain Current (pulsed)	29.2	29.2 (*)	A
P _{TOT}	Total Dissipation at T _C = 25°C	170	60	W
	Derating Factor	1.36	0.47	W/°C
dv/dt (1)	Peak Diode Recovery voltage slope	4		V/ns
V _{ISO}	Insulation Withstand Voltage (DC)	-	2500	V
T _{stg}	Storage Temperature	-65 to 150		°C
T _j	Max. Operating Junction Temperature	150		°C

(●) Pulse width limited by safe operating area

(1) I_{SD} ≤ 7.3 A, di/dt ≤ 200 A/ μ s, V_{DD} ≤ V(BR)DSS, T_j ≤ T_{JMAX}.

(*) Current Limited by Package

STU7NB90 - STU7NB90I

THERMAL DATA

		Max220	Max220I	
Rthj-case	Thermal Resistance Junction-case Max	0.734	2.1	°C/W
Rthj-amb	Thermal Resistance Junction-ambient Max	62.5		°C/W
T _l	Maximum Lead Temperature For Soldering Purpose	300		°C

AVALANCHE CHARACTERISTICS

Symbol	Parameter	Max Value	Unit
I _{AR}	Avalanche Current, Repetitive or Not-Repetitive (pulse width limited by T _j max)	7.3	A
E _{AS}	Single Pulse Avalanche Energy (starting T _j = 25 °C, I _D = I _{AR} , V _{DD} = 50 V)	600	mJ

ELECTRICAL CHARACTERISTICS (TCASE = 25 °C UNLESS OTHERWISE SPECIFIED)

OFF

Symbol	Parameter	Test Conditions	Min.	Typ.	Max.	Unit
V _{(BR)DSS}	Drain-source Breakdown Voltage	I _D = 250 μA, V _{GS} = 0	900			V
I _{DSS}	Zero Gate Voltage Drain Current (V _{GS} = 0)	V _{DS} = Max Rating V _{DS} = Max Rating, T _C = 125 °C			1 50	μA μA
I _{GSS}	Gate-body Leakage Current (V _{DS} = 0)	V _{GS} = ±30V			±100	nA

ON (1)

Symbol	Parameter	Test Conditions	Min.	Typ.	Max.	Unit
V _{GS(th)}	Gate Threshold Voltage	V _{DS} = V _{GS} , I _D = 250 μA	2	3	4	V
R _{DS(on)}	Static Drain-source On Resistance	V _{GS} = 10 V, I _D = 4 A		1.1	1.45	Ω

DYNAMIC

Symbol	Parameter	Test Conditions	Min.	Typ.	Max.	Unit
g _{fs} (1)	Forward Transconductance	V _{DS} > I _{D(on)} × R _{DS(on)max} , I _D = 4 A		8		S
C _{iss}	Input Capacitance	V _{DS} = 25V, f = 1 MHz, V _{GS} = 0		2120		pF
C _{oss}	Output Capacitance			225		pF
C _{riss}	Reverse Transfer Capacitance			23		pF

ELECTRICAL CHARACTERISTICS (CONTINUED)

SWITCHING ON

Symbol	Parameter	Test Conditions	Min.	Typ.	Max.	Unit
$t_{d(on)}$	Turn-on Delay Time	$V_{DD} = 450\text{ V}$, $I_D = 3.5\text{ A}$ $R_G = 4.7\Omega$, $V_{GS} = 10\text{ V}$ (see test circuit, Figure 3)		25		ns
t_r	Rise Time			12		ns
Q_g	Total Gate Charge	$V_{DD} = 720\text{ V}$, $I_D = 7.4\text{ A}$, $V_{GS} = 10\text{ V}$		51	72	nC
Q_{gs}	Gate-Source Charge			12.5		nC
Q_{gd}	Gate-Drain Charge			23.5		nC

SWITCHING OFF

Symbol	Parameter	Test Conditions	Min.	Typ.	Max.	Unit
$t_{r(Voff)}$	Off-voltage Rise Time	$V_{DD} = 720\text{ V}$, $I_D = 7.4\text{ A}$, $R_G = 4.7\Omega$, $V_{GS} = 10\text{ V}$ (see test circuit, Figure 5)		22		ns
t_f	Fall Time			15		ns
t_c	Cross-over Time			31		ns

SOURCE DRAIN DIODE

Symbol	Parameter	Test Conditions	Min.	Typ.	Max.	Unit
I_{SD}	Source-drain Current				7.3	A
$I_{SDM(2)}$	Source-drain Current (pulsed)				29.2	A
$V_{SD(1)}$	Forward On Voltage	$I_{SD} = 7.3\text{ A}$, $V_{GS} = 0$			1.6	V
t_{rr}	Reverse Recovery Time	$I_{SD} = 7.4\text{ A}$, $di/dt = 100\text{ A}/\mu\text{s}$, $V_{DD} = 100\text{ V}$, $T_j = 150^\circ\text{C}$ (see test circuit, Figure 5)		700		ns
Q_{rr}	Reverse Recovery Charge			6.3		μC
I_{RRM}	Reverse Recovery Current			18		A

Note: 1. Pulsed: Pulse duration = 300 μs , duty cycle 1.5 %.
2. Pulse width limited by safe operating area.

Safe Operating Area for Max220

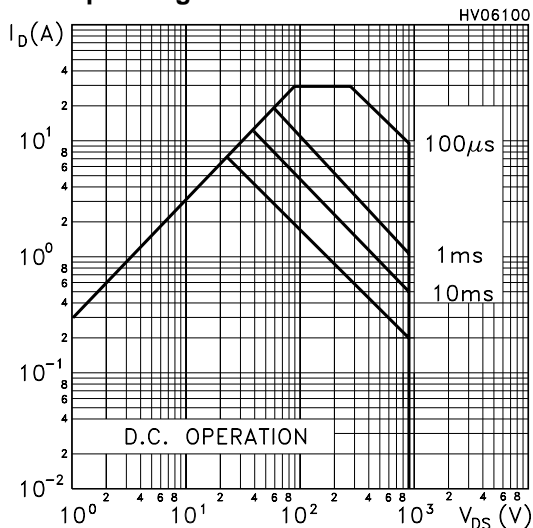

Safe Operating Area for Max220I

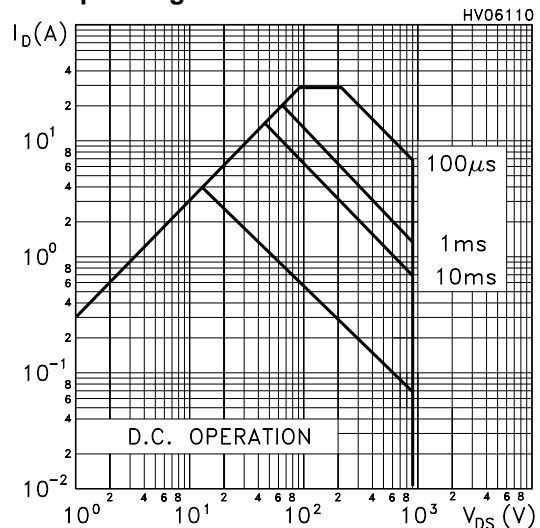

Thermal Impedance for Max220

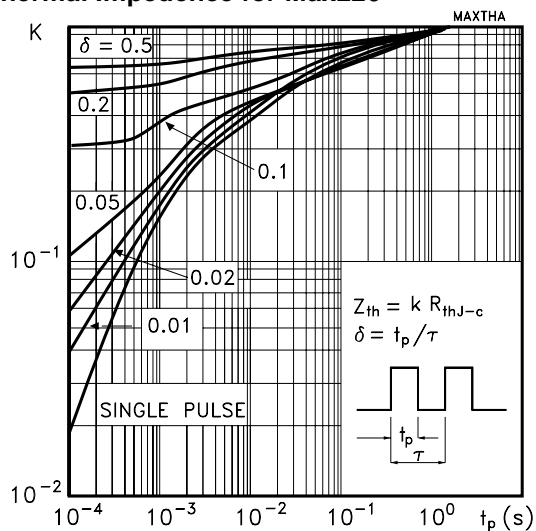

Thermal Impedance for Max220I

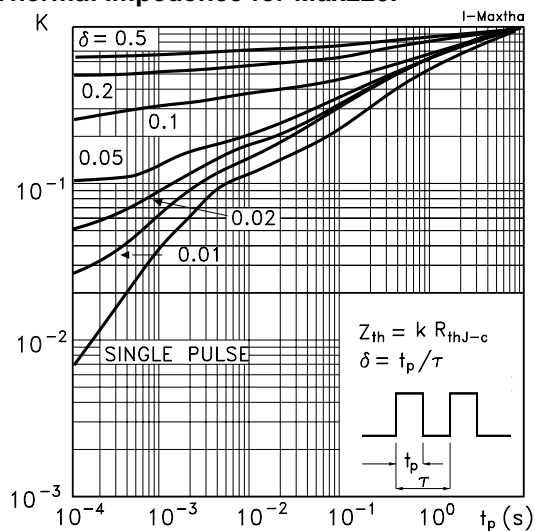

Output Characteristics

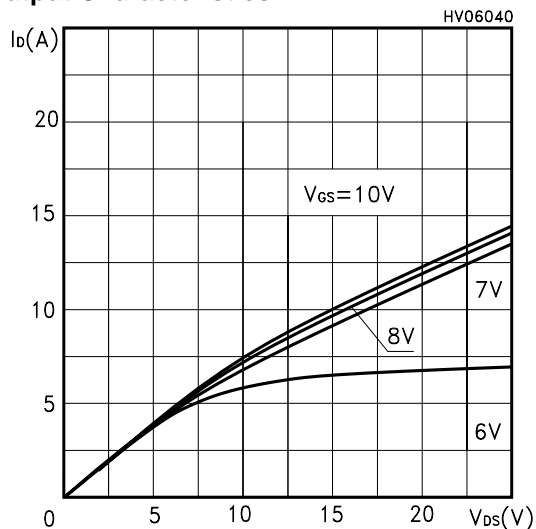

Transfer Characteristics

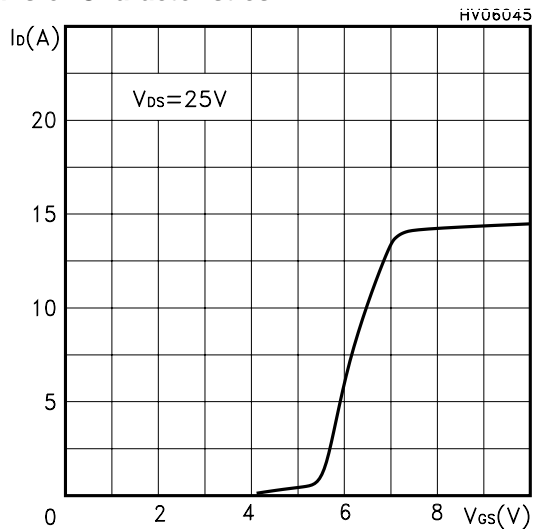

Transconductance

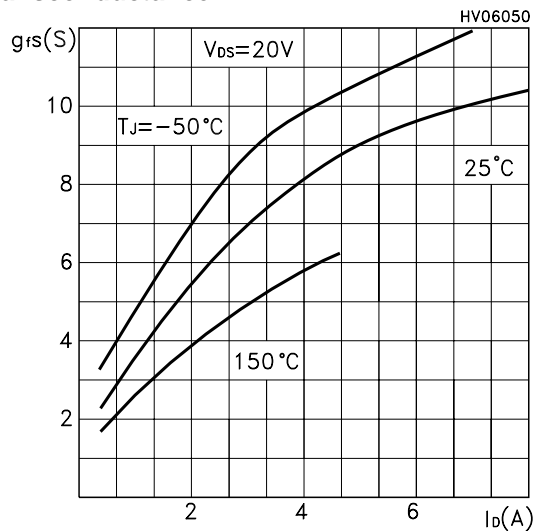

Static Drain-source On Resistance

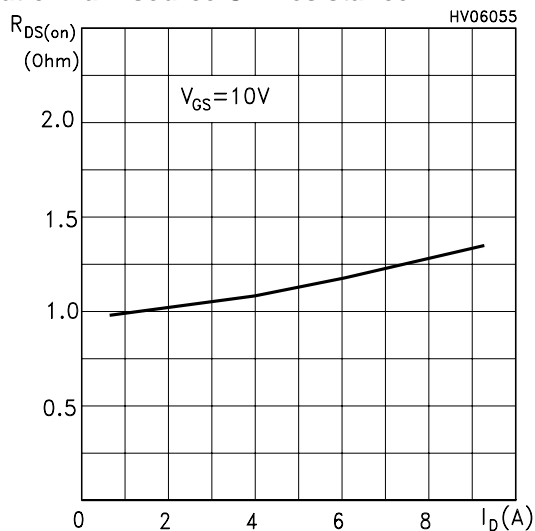

Gate Charge vs Gate-source Voltage

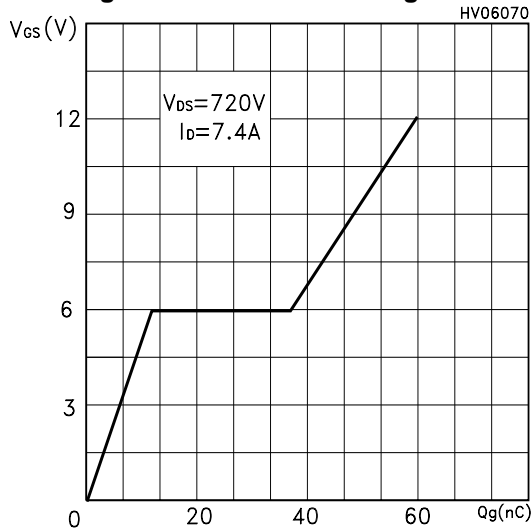

Normalized Gate Threshold Voltage vs Temp.

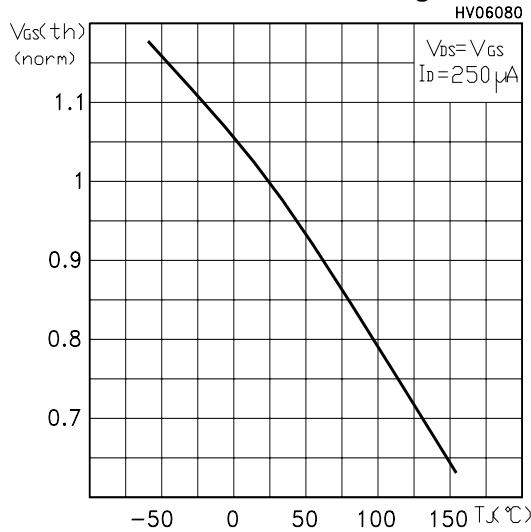

Capacitance Variations

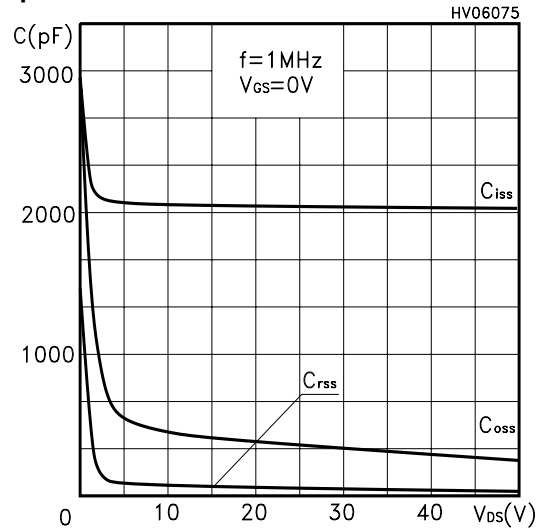

Normalized On Resistance vs Temperature

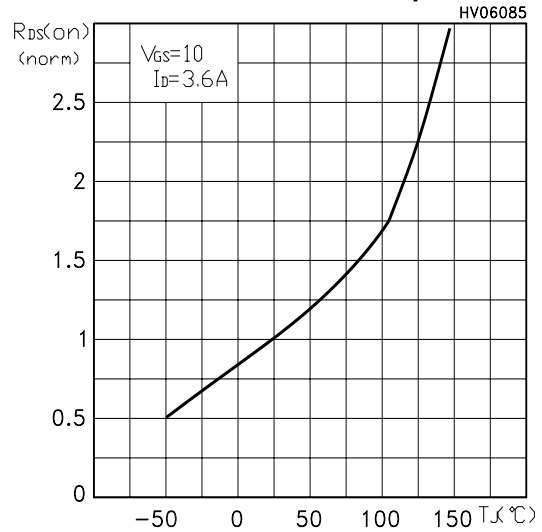

Source-drain Diode Forward Characteristics

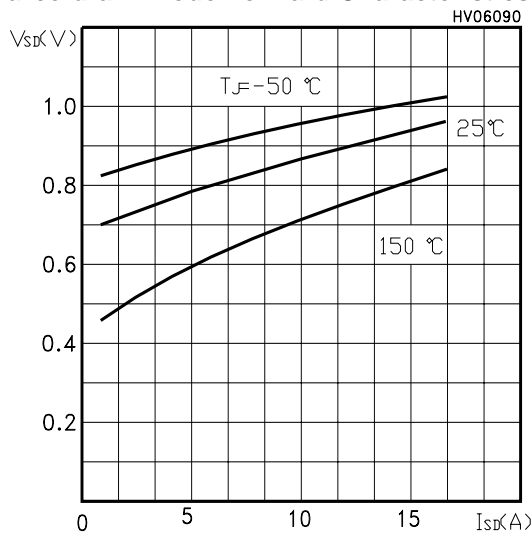

Fig. 1: Unclamped Inductive Load Test Circuit



Fig. 2: Unclamped Inductive Waveform



Fig. 3: Switching Times Test Circuit For Resistive Load



Fig. 4: Gate Charge test Circuit

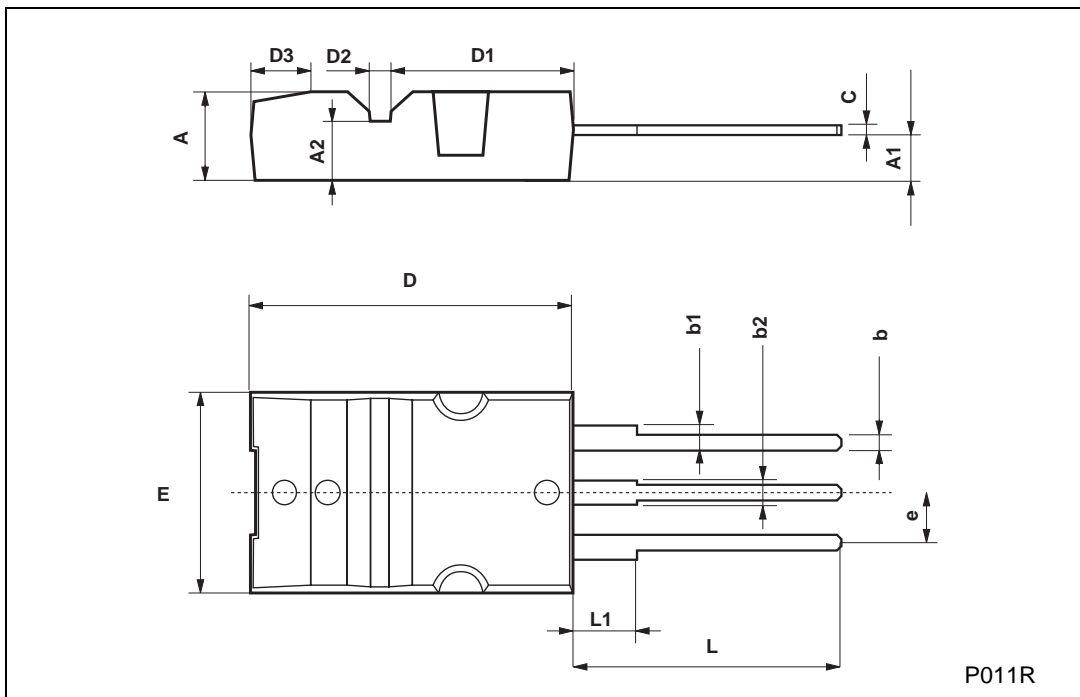

Fig. 5: Test Circuit For Inductive Load Switching And Diode Recovery Times



Max220 MECHANICAL DATA

DIM.	mm			inch		
	MIN.	TYP.	MAX.	MIN.	TYP.	MAX.
A	4.3		4.6	0.169		0.181
A1	2.2		2.4	0.087		0.094
A2	2.9		3.1	0.114		0.122
b	0.7		0.93	0.027		0.036
b1	1.25		1.4	0.049		0.055
b2	1.2		1.38	0.047		0.054
c	0.45		0.6		0.18	0.023
D	15.9		16.3		0.626	0.641
D1	9		9.35	0.354		0.368
D2	0.8		1.2	0.031		0.047
D3	2.8		3.2	0.110		0.126
e	2.44		2.64	0.096		0.104
E	10.05		10.35	0.396		0.407
L	13.2		13.6	0.520		0.535
L1	3		3.4	0.118		0.133



P011R

I-Max220 MECHANICAL DATA

DIM.	mm			inch		
	MIN.	TYP.	MAX.	MIN.	TYP.	MAX.
A	4.3		4.6	0.169		0.181
A1	2.6		2.75	0.102		0.108
A2	1.95		2.15	0.077		0.084
b	0.7		0.93	0.027		0.036
b1	1.25		1.4	0.049		0.055
b2	1.2		1.38	0.047		0.054
c	0.45		0.6	0.017		0.023
D	15.9		16.3	0.626		0.641
D1	12.5		12.9	0.492		0.508
D2	0.6		1	0.023		0.039
D3	1.75		2.15	0.069		0.084
e	2.44		2.64	0.096		0.104
E	10.05		10.35	0.396		0.407
L	13.2		13.6	0.520		0.535
L1	3		3.4	0.118		0.133

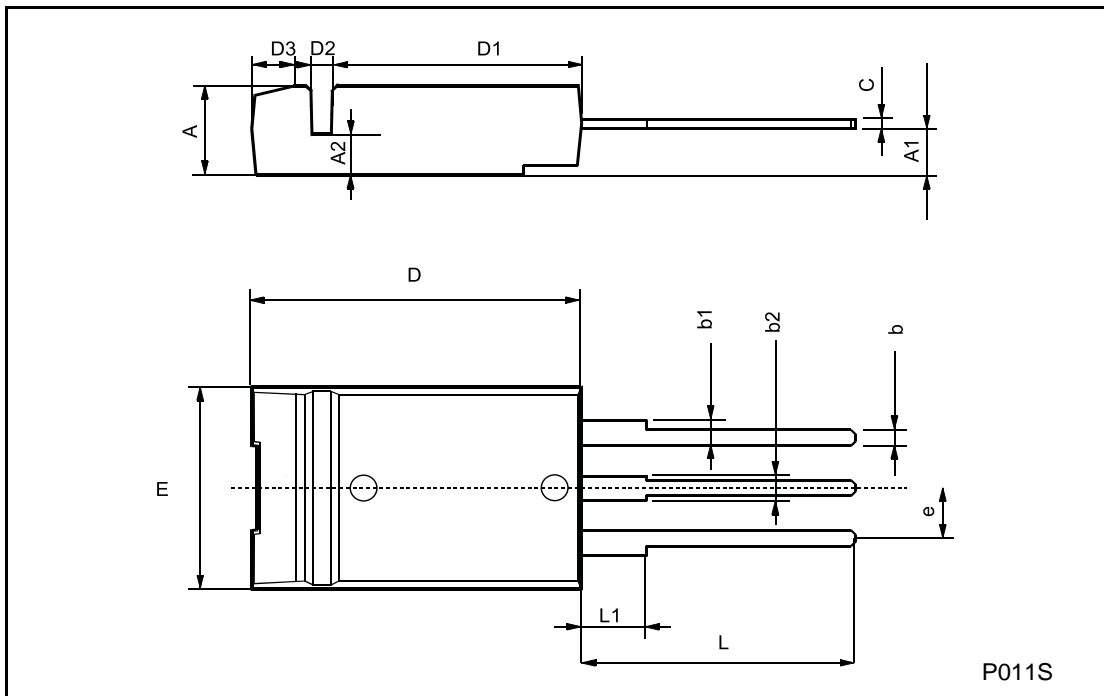

Information furnished is believed to be accurate and reliable. However, STMicroelectronics assumes no responsibility for the consequences of use of such information nor for any infringement of patents or other rights of third parties which may result from its use. No license is granted by implication or otherwise under any patent or patent rights of STMicroelectronics. Specification mentioned in this publication are subject to change without notice. This publication supersedes and replaces all information previously supplied. STMicroelectronics products are not authorized for use as critical components in life support devices or systems without express written approval of STMicroelectronics.

The ST logo is a trademark of STMicroelectronics

© 2000 STMicroelectronics – Printed in Italy – All Rights Reserved

STMicroelectronics GROUP OF COMPANIES

Australia - Brazil - China - Finland - France - Germany - Hong Kong - India - Italy - Japan - Malaysia - Malta - Morocco -
Singapore - Spain - Sweden - Switzerland - United Kingdom - U.S.A.

<http://www.st.com>