



3D SURROUND AUDIO PROCESSOR

■ GENERAL DESCRIPTION

The **NJM2702** is a 3D surround audio processor regenerating the 3D surround sound with only two speakers.

The **NJM2702** is suitable for audio applications, which are speaker system for mini components, CD radio cassette, multimedia speaker systems, TV and others.

■ PACKAGE OUTLINE

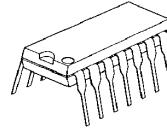

NJM2702D

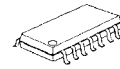

NJM2702M



NJM2702V

■ FEATURES

- Operating Voltage (4.7 to 13V)
- Stereo mode
 - Stable center image with natural sound field
 - High quality Surround
 - Free speaker interval
- Surround control
- Internal Mode Control Switch
- Bipolar Technology
- Package Outline DIP14, DMP14, SSOP10

■ BLOCK DIAGRAM

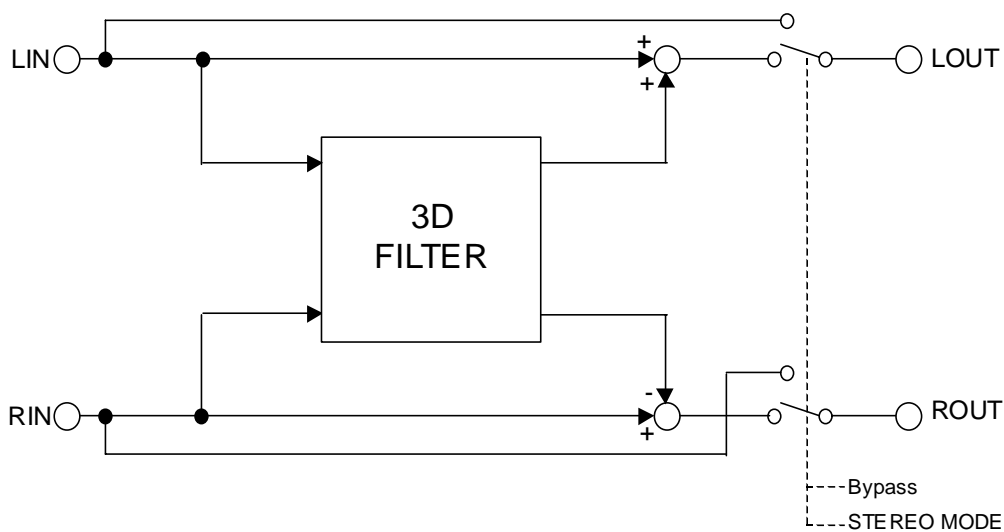

NJM2702

■ABSOLUTE MAXIMUM RATING (Ta=25°C)

PARAMETER	SYMBOL	RATINGS	UNIT
Supply Voltage	V ⁺	14	V
Power Dissipation	P _D	(DIP14) 500 (DMP14) 350 (SSOP10) 250	mW
Operating Temperature Range	T _{opr}	-40 to +85	°C
Storage Temperature Range	T _{stg}	-40 to +125	°C

■OPERATING VOLTAGE

PARAMETER	SYMBOL	TEST CONDITION	MIN.	TYP.	MAX.	UNIT
Operating Voltage	V ⁺	-	4.7	12.0	13.0	V

■ELECTRICAL CHARACTERISTICS (V⁺=12V, Ta=25°C unless otherwise specified)

PARAMETER	SYMBOL	TEST CONDITION					MIN.	TYP.	MAX.	UNIT	
		INPUT		OUTPUT	MODE	VR					
		L	R								
Operating Current	I _{cc}	No Signal	0	0	-	BYPASS	-	3.0	6.0	9.0	mA
			0	0	-	Stereo	MAX	3.0	6.0	9.0	

●AC CHARACTERISTICS

(V⁺=12V, Ta=25°C, V_{IN}=-10dBV(316mVrms), f=1kHz, RL=4.7kΩ, unless otherwise specified)

PARAMETER	SYMBOL	TEST CONDITION					MIN.	TYP.	MAX.	UNIT	
		INPUT		OUTPUT	MODE	VR					
		L	R								
Maximum Input Voltage	V _{IM}	f=1kHz T.H.D.=3%	V _{IN} 0	0 V _{IN}	L R	BYPASS	-	9.9 (3.1)	11.9 (3.9)	-	dBV (Vrms)
		f=100Hz T.H.D.=3%	V _{IN} 0	0 V _{IN}	L R	Stereo	MAX	-3.8 (0.6)	-1.8 (0.8)	-	
Output Noise	V _{NO}	R _g =0Ω A-Weighted	0	0	L R	BYPASS	-	-	-112 (2.5)	-106 (5.0)	dBV (μVrms)
		R _g =0Ω A-Weighted	0	0	L R	Stereo	MAX	-	-100 (10)	-94 (20)	
Total Harmonic Distortion	T.H.D	f=1kHz	V _{IN} 0	0 V _{IN}	L R	BYPASS	-	-	0.005	0.01	%
		f=1kHz Vin=-20dBV	V _{IN} 0	0 V _{IN}	L R	Stereo	MAX	-	0.1	0.5	
Bypass Gain	G _{VBYP}	f=1kHz	V _{IN} 0	0 V _{IN}	L R	BYPASS	-	-1.0	0.0	1.0	dB

●AC CHARACTERISTICS

($V_+ = 12V, T_a = 25^\circ C, V_{IN} = -10dBV(316mV_{rms}), f = 1kHz, R_L = 4.7k\Omega$, unless otherwise specified)

PARAMETER	SYMBOL	TEST CONDITION						MIN.	TYP.	MAX.	UNIT
		INPUT		OUTPUT	MODE	VR					
		L	R								
Surround Gain	G_{VSUR}	$f=100Hz$ $V_{in}=-20dBV$	V_{IN} 0	0 V_{IN}	L R	Stereo	MAX	10.7	12.7	14.7	dB
		$f=100Hz$ $V_{in}=-20dBV$	0 V_{IN}	V_{IN} 0	L R	Stereo	MAX	8.4	10.4	12.4	
		$f=100Hz$ $V_{in}=-20dBV$	V_{IN} 0	0 V_{IN}	L R	Stereo	MIN	3.6	5.6	7.6	

●CONTROL CHARACTERISTICS ($V_+ = 12V, T_a = 25^\circ C$ unless otherwise specified)

PARAMETER	SYMBOL	TEST CONDITION						MIN.	TYP.	MAX.	UNIT
		INPUT		OUTPUT	MODE	VR					
		L	R								
Mode Select Control Voltage	V_{MODE}	$V_{IN} =$ High Level	-	-	-	-	-	2.0	-	V_+	V
		$V_{IN} =$ Low Level	-	-	-	-	-	0.0	-	0.7	



■MODE SWITCH

MODE	SW	NOTES
BYPASS	L	Input Through
Stereo	H	Surround Mode (Stereo Input)

NJM2702

■ TERMINAL DESCRIPTION

PIN NO.		SYMBOL	FUNCTION	EQUIVALENT CIRCUIT	VOLTAGE
DIP14 DMP14	SSOP10				
1	1	FIL	Filter Input		$V+/2$
2 4 8 10	-	NC	Test pin		
3	2	VOL	Surround VR		$V+/2$
5	3	VREFIN	Reference Voltage Input		$V+/2$

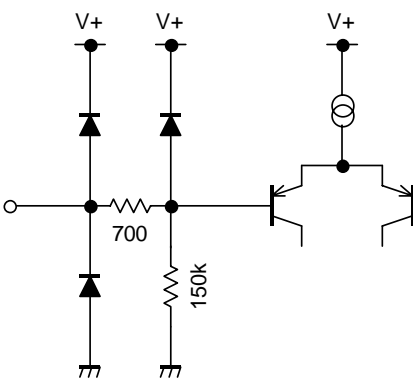
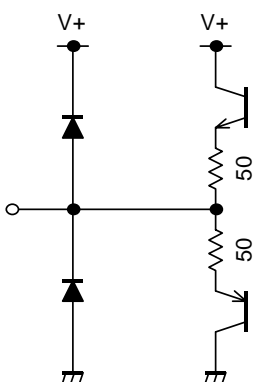
PIN NO.		SYMBOL	FUNCTION	EQUIVALENT CIRCUIT	VOLTAGE
DIP14 DMP14	SSOP10				
6	4	V+	Power Supply		V+
7	5	GND	GND		0V
9	6	SW	Mode Control Switch		0V
11 12	7 8	ROUT LOUT	Rch Output Lch Output		V+/2

NJM2702

PIN NO.		SYMBOL	FUNCTION	EQUIVALENT CIRCUIT	VOLTAGE
DIP14 DMP14	SSOP10				
13 14	9 10	RIN LIN	Rch Input Lch Input		V+/2

APPLICATION CIRCUIT

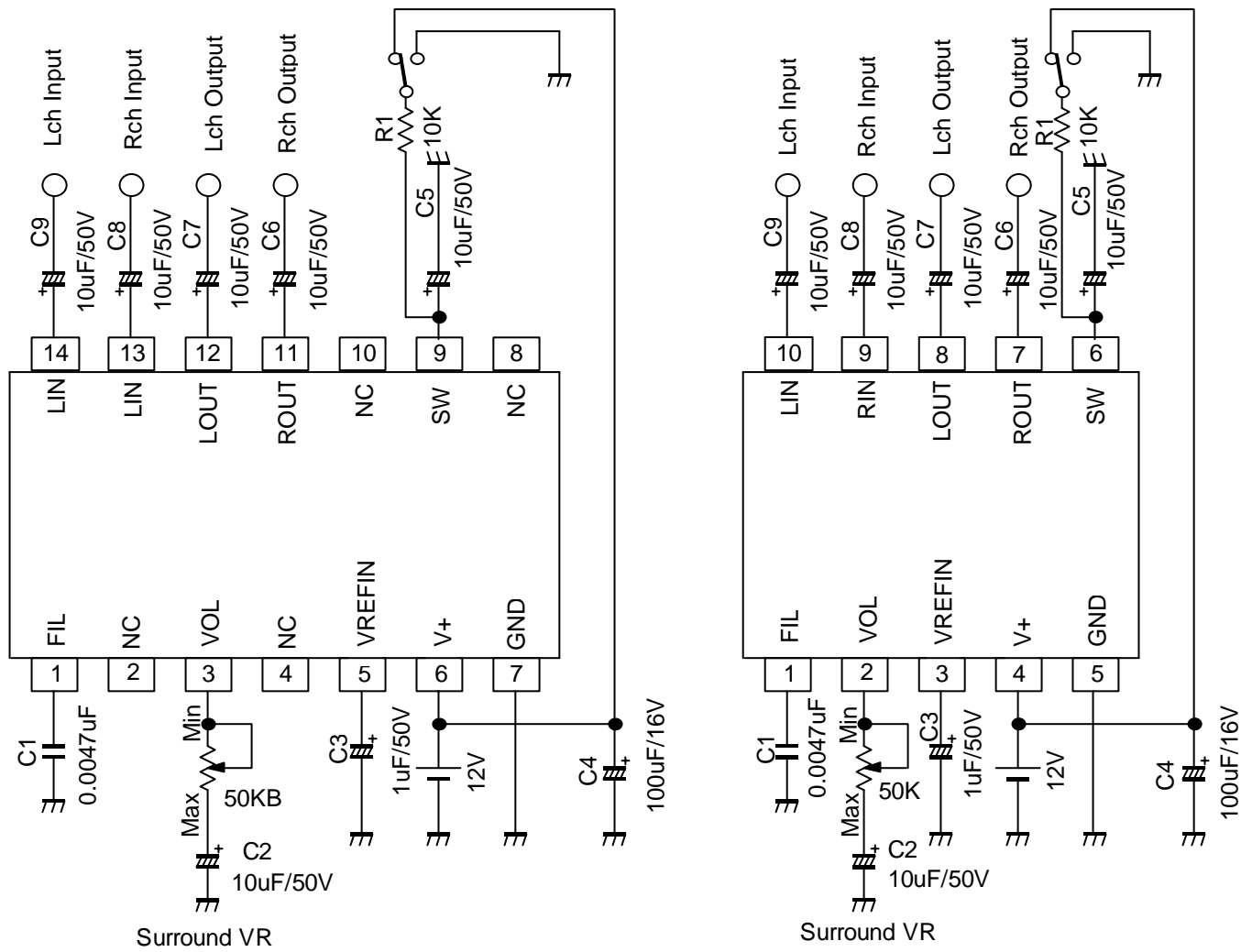

Parts No.	Value	Tolerance	Parts No.	Value	Tolerance
R1	10k Ω	5%	C3	1 μ F	20%
C1	0.0047 μ F	5%	C4	100 μ F	20%
C2,C5,C6,C7,C8,C9	10 μ F	20%			

NJM2702

TYPICAL CHARACTERISTICS

Supply Current vs Supply Voltage

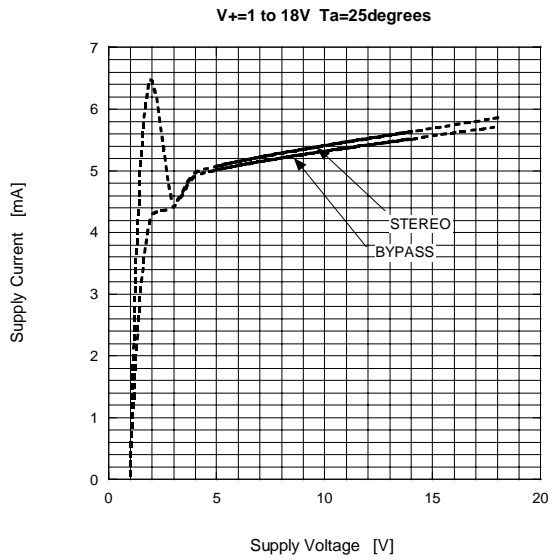

Supply Current vs Ambient Temperature

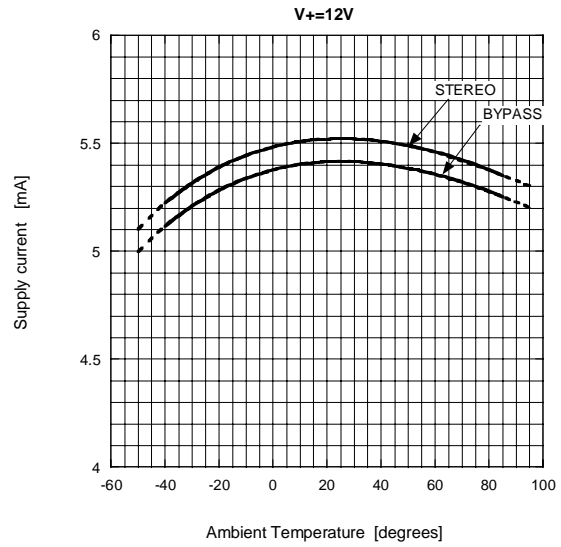

Maximum Input Voltage vs Supply Voltage (BYPASS)

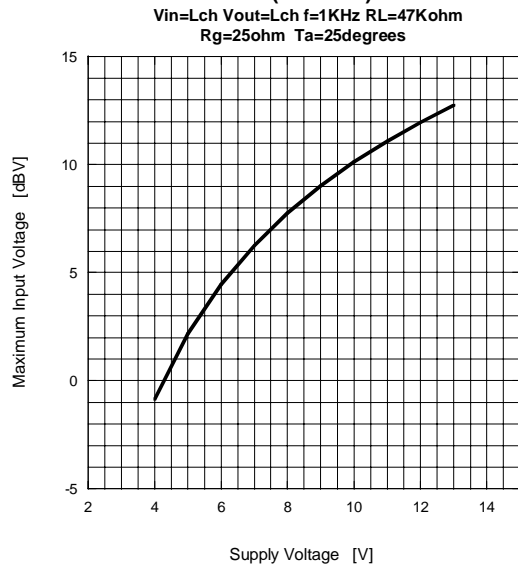

Maximum Input Voltage vs Supply Voltage (STEREO)

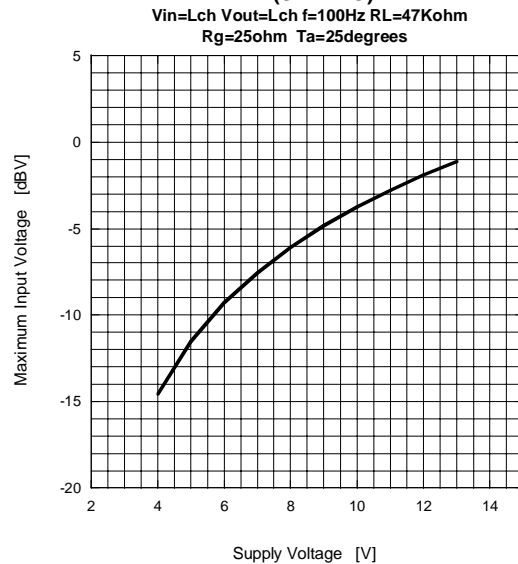

Output Noise vs Ambient Temperature

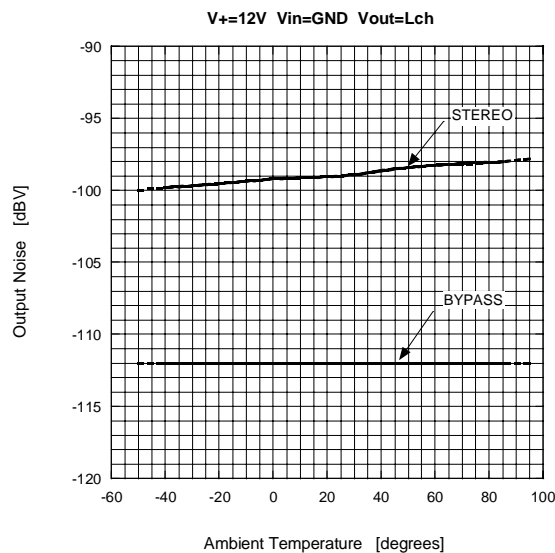

Output Noise vs Ambient Temperature

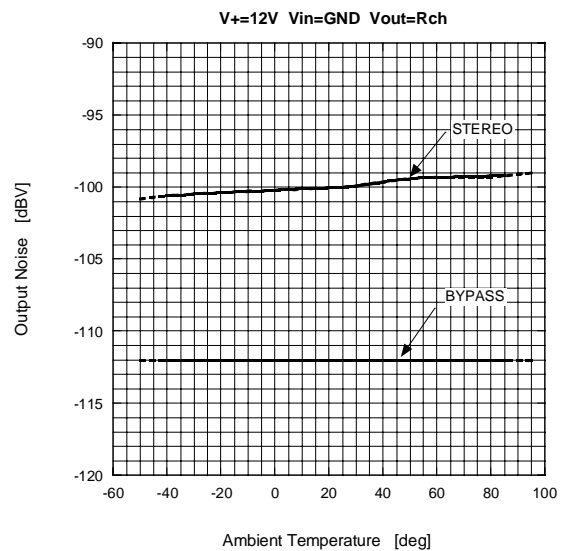

TYPICAL CHARACTERISTICS

Total Harmonic Distortion vs Input Voltage (BYPASS)

V+=12V f=100Hz RL=47Kohm
Rg=25ohm BW=10 to 80KHz

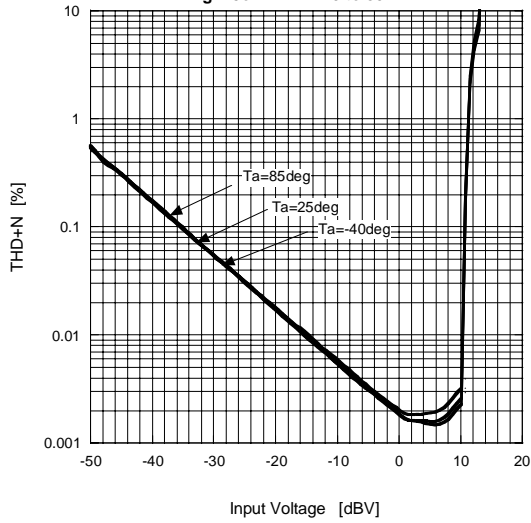

Total Harmonic Distortion vs Input Voltage (BYPASS)

V+=12V f=1KHz RL=47Kohm
Rg=25ohm BW=10 to 80KHz

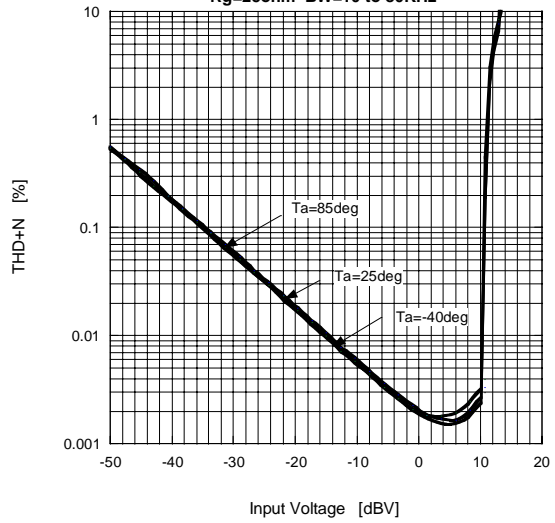

Total Harmonic Distortion vs Input Voltage (STEREO)

V+=12V f=100Hz RL=47Kohm
Rg=25ohm BW=10 to 80KHz

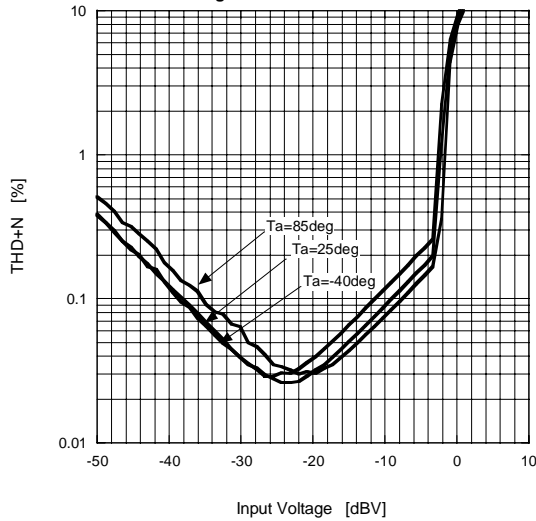

Total Harmonic Distortion vs Input Voltage (STEREO)

V+=12V f=1KHz RL=47Kohm
Rg=25ohm BW=10 to 80KHz

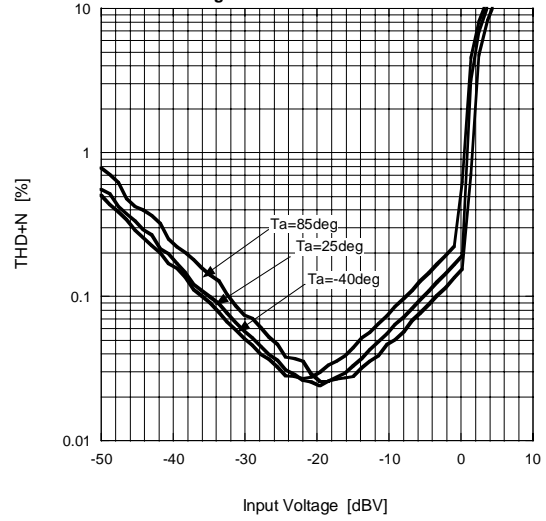

Voltage Gain vs Frequency Response (BYPASS)

V+=12V Vin=10dBV Lch Vout=Lch
RL=47Kohm Rg=25ohm

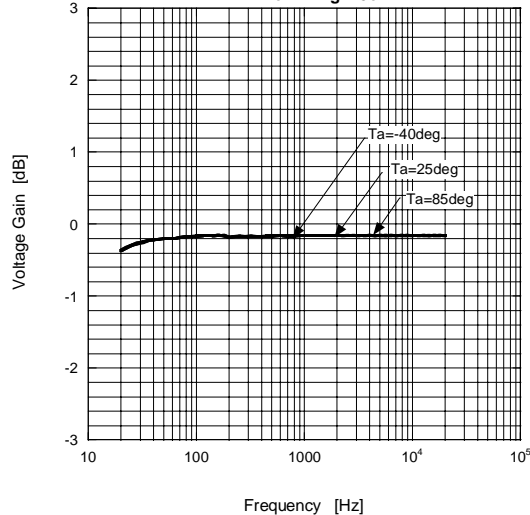

Voltage Gain vs Frequency Response (BYPASS)

V+=12V Vin=10dBV Rch Vout=Rch
RL=47Kohm Rg=25ohm

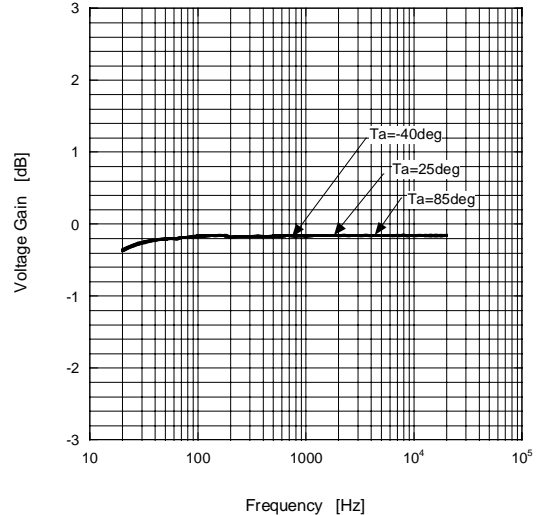

TYPICAL CHARACTERISTICS

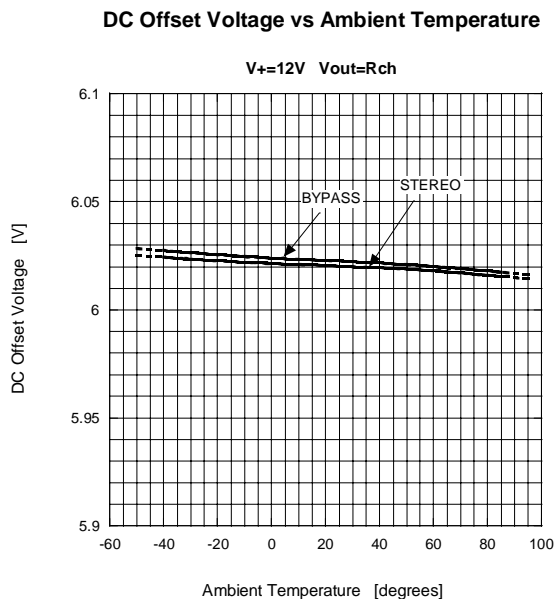
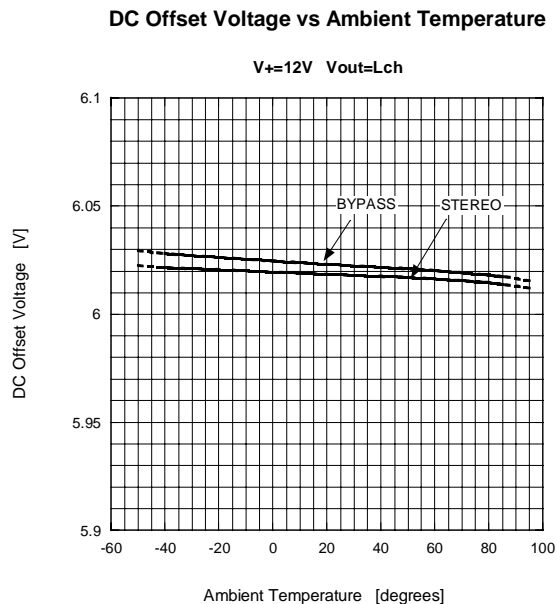
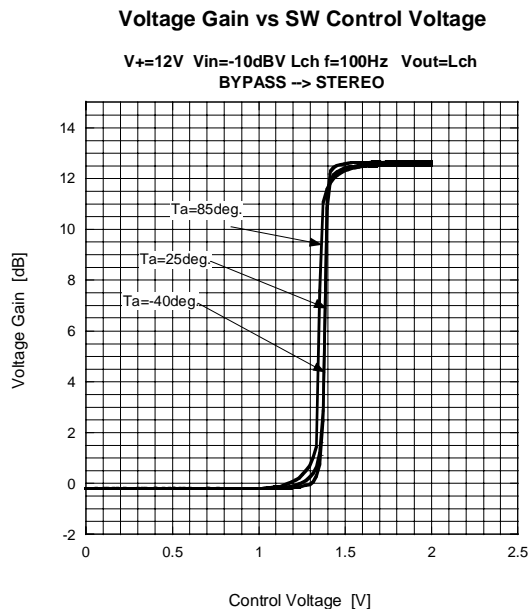
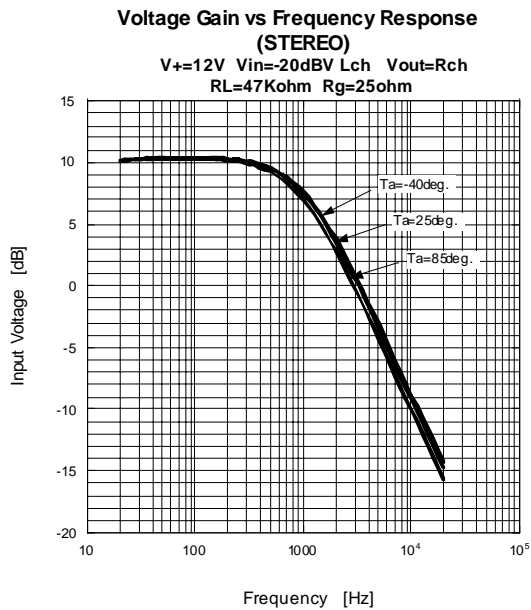
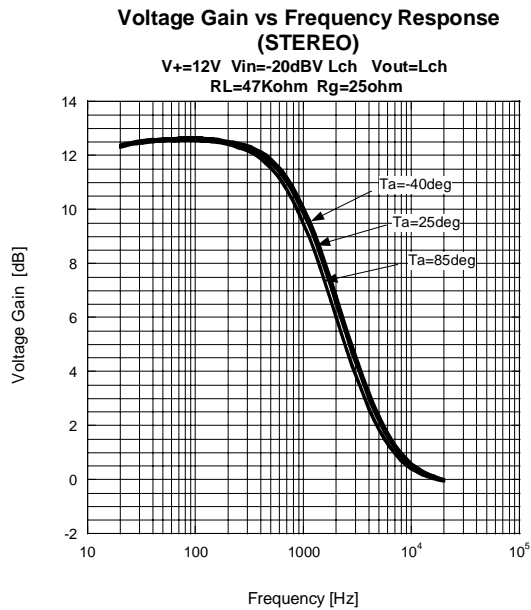

[CAUTION]
 The specifications on this databook are only given for information, without any guarantee as regards either mistakes or omissions. The application circuits in this databook are described only to show representative usages of the product and not intended for the guarantee or permission of any right including the industrial rights.