



Am2168/Am2169

4096 X 4 Static R/W Random-Access Memory

DISTINCTIVE CHARACTERISTICS

- High speed — access times as fast as 40 ns
- Fully static storage and interface circuitry
- No clocks or timing signals required
- Automatic power down when deselected (Am2168)
- Power dissipation
 - Am2168: 660 mW active, 165 mW standby
 - Am2169: 660 mW
- Standard 20-pin, .300 inch dual-in-line package
- Standard 20-pin rectangular ceramic leadless chip carrier
- High output drive
 - Up to seven standard TTL loads or six Schottky TTL loads
- TTL-compatible interface levels

GENERAL DESCRIPTION

The Am2168 and Am2169 are high-performance, static, N-channel, read/write, random-access memories organized as 4096 words of 4 bits. Operation is from a single 5 V supply, and all input/output levels are identical to standard TTL specifications. The Am2168 and Am2169 are the same except that the Am2168 offers an automatic Chip Enable (\overline{CE}) power-down feature.

The Am2168 remains in a low-power standby mode as long as \overline{CE} remains HIGH, thus reducing its power requirements from 660 mW to 165 mW maximum.

The data read out is not destructive and has the same polarity as the input data. The device is packaged in either a .300 slim DIP or 20-pin leadless chip carrier. The outputs of similar devices can be OR-tied and easy selection obtained by use of the \overline{CE} .

BLOCK DIAGRAM

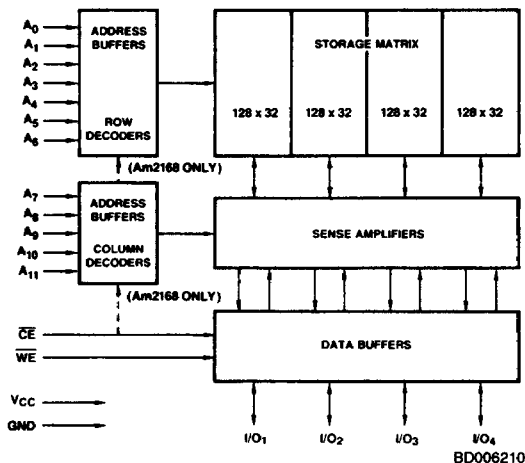

4

PRODUCT SELECTOR GUIDE

Part Number	Am2168-35	Am2168-45	Am2169-40	Am2168-55	Am2169-50	Am2168-70	Am2169-70
Maximum Access Time (ns)	35	45	40	55	50	70	70
0 to +70°C	I _{CC} (mA)	120	120	120	120	120	120
	I _{SB} * (mA)	30	30	N/A	30	N/A	N/A
-55 to +125°C	I _{CC} (mA)	N/A	160	N/A	160	160	160
	I _{SB} * (mA)	N/A	30	N/A	30	N/A	N/A

*Am2168

CONNECTION DIAGRAMS Top View

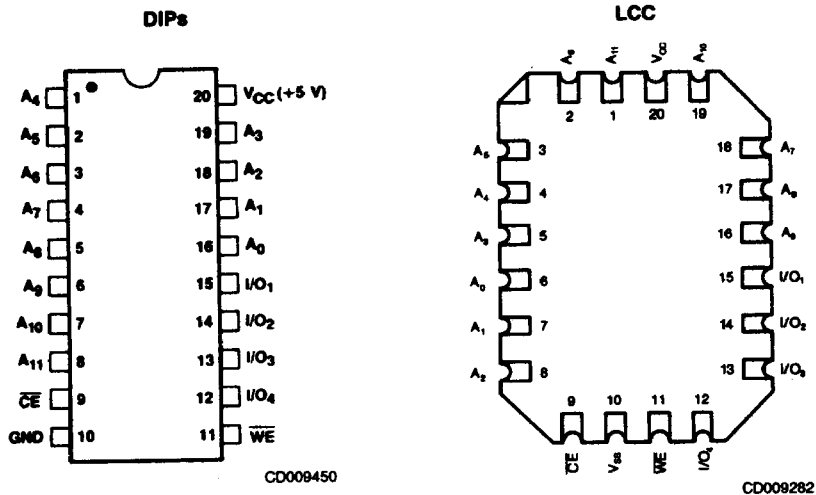

Note: Pin 1 is marked for orientation.

METALLIZATION AND PAD LAYOUT

Address Designators	
External	Internal
A ₀	A ₀
A ₁	A ₁
A ₂	A ₂
A ₃	A ₃
A ₄	A ₄
A ₅	A ₅
A ₆	A ₆
A ₇	A ₇
A ₈	A ₈
A ₉	A ₁₁
A ₁₀	A ₁₀
A ₁₁	A ₉

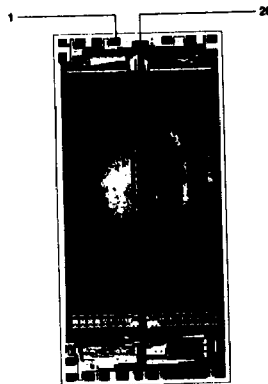

Die Size: 0.123" x 0.252"

ORDERING INFORMATION

Standard Products

AMD standard products are available in several packages and operating ranges. The order number (Valid Combination) is formed by a combination of:

- a. Device Number
- b. Speed Option (if applicable)
- c. Package Type
- d. Temperature Range
- e. Optional Processing

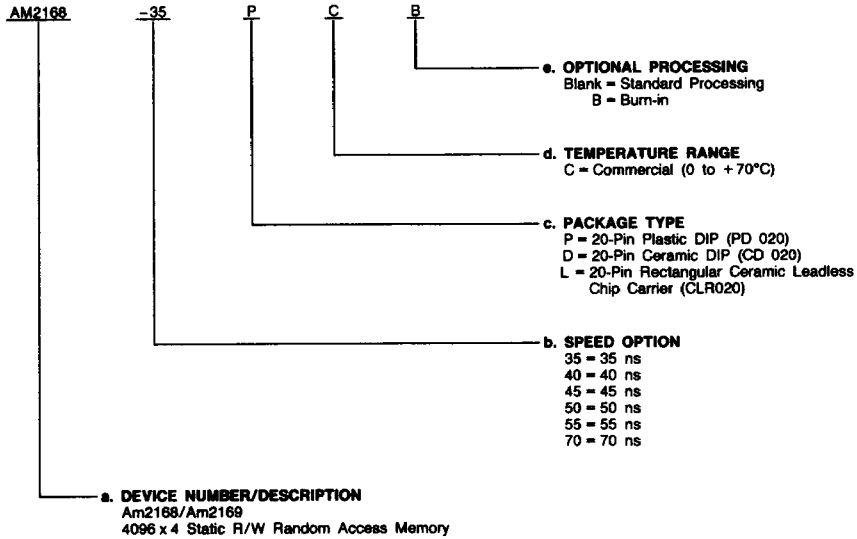

Valid Combinations	
AM2168-35	PC, PCB, DC,
AM2169-40	DCB, LC, LCB
AM2168-45	PC, PCB, DC, DCB
AM2168-55	
AM2169-50	
AM2168-70	
AM2169-70	

Valid Combinations

Valid Combinations list configurations planned to be supported in volume for this device. Consult the local AMD sales office to confirm availability of specific valid combinations, to check on newly released combinations, and to obtain additional data on AMD's standard military grade products.

MILITARY ORDERING INFORMATION

APL Products

AMD products for Aerospace and Defense applications are available in several packages and operating ranges. APL (Approved Products List) products are fully compliant with MIL-STD-883C requirements. The order number (Valid Combination) is formed by a combination of:

- a. Device Number
- b. Speed Option (if applicable)
- c. Device Class
- d. Package Type
- e. Lead Finish

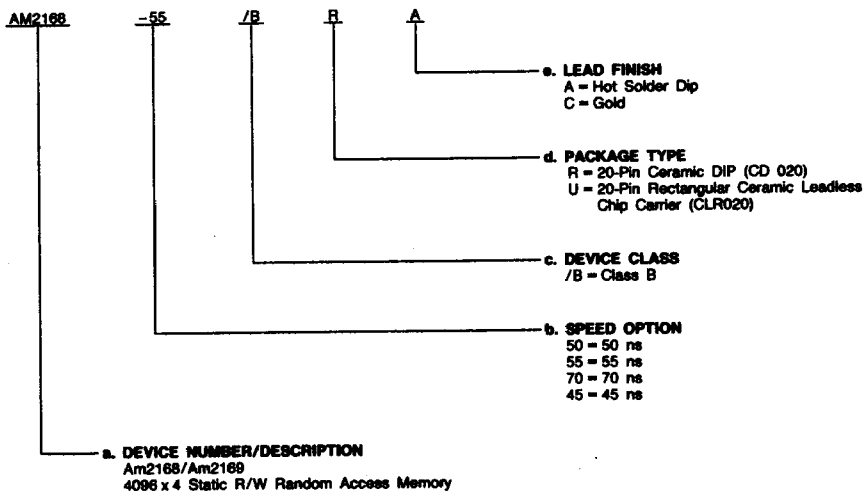

Valid Combinations	
AM2168-45	/BRA, /BUA
AM2168-55	
AM2168-50	
AM2168-70	
AM2168-45	
AM2168-55	
AM2168-50	
AM2168-70	
AM2168-45	
AM2168-70	

Valid Combinations

Valid Combinations list configurations planned to be supported in volume for this device. Consult the local AMD sales office to confirm availability of specific valid combinations or to check for newly released valid combinations.

Group A Tests

Group A tests consist of Subgroups 1, 2, 3, 7, 8, 9, 10, 11.

PIN DESCRIPTION

A₀-A₁₁ Address Inputs (Inputs)

The address input lines select the RAM location to be read or written.

CE Chip Enable (Input, Active LOW)

The Chip Enable selects the memory device.

WE Write Enable (Input, Active LOW)

When Write Enable is LOW and Chip Enable is also LOW, data is written into the location specified on the address pins.

I/O₁-I/O₄ Data In/Out Bus (Bidirectional Active HIGH)

These I/O lines provide the path for data to be read from or written to the selected memory location.

V_{CC} Power Supply

V_{SS} Ground

ABSOLUTE MAXIMUM RATINGS*

Supply Voltage	-0.5 V to +7.0 V
All Signal Voltages	-3.5 V to +7.0 V
DC Output Current	20 mA
Power Dissipation	
Cerdip & Leadless Packages	1.2 W
Plastic Packages	0.7 W
Ambient Temperature with Power Applied	
Cerdip & Leadless Packages	-55 to +125°C
Plastic Packages	-10 to +85°C
Storage Temperature	
Cerdip & Leadless Packages	-65 to +150°C
Plastic Packages	-55 to +150°C

Stresses above those listed under ABSOLUTE MAXIMUM RATINGS may cause permanent device failure. Functionality at or above these limits is not implied. Exposure to absolute maximum ratings for extended periods may affect device reliability.

*Maximum ratings are for system design reference; parameters given may not be 100% tested.

OPERATING RANGES (Note 4)

Commercial (C) Devices	
Ambient Temperature (T _A)	0 to +70°C
Supply Voltage (V _{CC})	4.5 V to +5.5 V
Military (M) Devices	
Ambient Temperature (T _A)	-55 to +125°C
Supply Voltage (V _{CC})	+4.5 to +5.5 V

Operating ranges define those limits between which the functionality of the device is guaranteed.

DC CHARACTERISTICS over operating ranges unless otherwise specified (for APL Products, Group A, Subgroups 1, 2, 3 are tested unless otherwise noted) (Note 4)

Parameter Symbol	Parameter Description	Test Conditions	Am2168-35, -45, & -40		Am2168-55 & -70 Am2169-50 & -70		Unit
			Min.	Max.	Min.	Max.	
I _{OH}	Output HIGH Current	V _{OH} = 2.4 V	V _{CC} = 4.5 V		-4	-4	mA
I _{OL}	Output LOW Current	V _{OL} = 0.4 V	COM'L		8	8	mA
			MIL		8	8	
V _{IH}	Input HIGH Voltage		2.2	6.0	2.2	6.0	V
V _{IL}	Input LOW Voltage	Note 3	-0.5	0.8	-0.5	0.8	V
I _{Ix}	Input Load Current	GND ≤ V _I ≤ V _{CC}	-10	10	-10	10	μA
I _{OZ}	Output Leakage Current	GND ≤ V _O ≤ V _{CC} Output Disabled	-50	50	-50	50	μA
C _I	Input Capacitance	Test Frequency = 1.0 MHz		5		5	pF
C _{I/O}	Input/Output Capacitance	T _A = 25°C, All Pins at 0 V, V _{CC} = 5 V (Note 5)		7		7	
I _{CC}	V _{CC} Operating Supply Current	Max. V _{CC} , CE ≤ V _{IL} Output Open	COM'L		120	120	mA
			MIL		N/A	160	
I _{SB}	Automatic \overline{CE} Power Down Current (Am2168 Only)	Max. V _{CC} , (CE ≥ V _{IH})	COM'L		30	30	mA
			MIL		N/A	30	

- Notes:
1. Test conditions assume signal transition times of 5 ns or less, timing reference levels of 1.5 V, input pulse levels of 0 to 3.0 V and output loading of the specified I_{OL}/I_{OH} and 30 pF load capacitance. Output timing reference is 1.5 V.
 2. The internal write time of the memory is defined by the overlap of \overline{CE} LOW and \overline{WE} LOW. Both signals must be LOW to initiate a write and either signal can terminate a write by going HIGH. The data input setup and hold timing should be referenced to the rising edge of the signal that terminates the write.
 3. V_{IL} voltages of less than -0.5 V on the I/O pins will cause the output current to exceed the maximum rating and thus should not exceed 30 seconds in duration.
 4. For test and correlation purposes, ambient temperature is defined as the "Instant-on" case temperature.
 5. At any given temperature and voltage condition, t_{HZ} is less than t_{LZ} and t_{WZ} is less than t_{OW} for all devices. Transition is measured at 1.5 V on the input to V_{OH} - 500 mV and V_{OL} + 500 mV on the outputs using the load shown in B. under Switching Test Circuits. C_L = 5 pF.
 6. Not 100% tested parameter; parameter guaranteed by characterization.

SWITCHING CHARACTERISTICS over operating ranges unless otherwise specified (for APL Products, Group A, Subgroups 9, 10, 11 are tested unless otherwise noted) (Note 1)

No.	Parameter Symbol	Parameter Description	Am2168-35		Am2168-45, Am2169-40		Am2168-55, Am2169-50		Am2168-70, Am2169-70		Unit	
			Min.	Max.	Min.	Max.	Min.	Max.	Min.	Max.		
READ CYCLE												
1	t _{RC}	Address Valid to Address Do Not Care Time (Read Cycle Time)	35		40		50		70		ns	
2	t _{AA}	Address Valid to Data Out Valid Delay (Address Access Time)		35		40		50		70	ns	
3	t _{ACS}	Chip Enable LOW to Data Out Valid (Chip Enable Access Time)		35		45		55		70	ns	
4	t _{LZ}	Chip Enable LOW to Data Out On	Am2168	(Notes 4, 5)	5		5		5			
			Am2169			2		2		2		
5	t _{HZ}	Chip Enable HIGH to Data Out Off	(Notes 4, 5)	0	20	0	20	0	25	0	30	ns
6	t _{OH}	Output hold time from address change	COM'L		3		3		3			
			MIL			1		1		1		
7	t _{PD}	Chip Enable HIGH to Power-Down Delay	Am2168	(Note 5)		35		45		55	70	ns
8	t _{PJ}	Chip Enable LOW to Power-Up Delay	Am2168	(Note 5)	0		0		0		0	ns
WRITE CYCLE												
9	t _{WC}	Address Valid to Address Do Not Care (Write Cycle Time)		35		40		50		70		ns
10	t _{WP}	Write Enable LOW to Write Enable HIGH	(Note 2)	30		35		45		65		ns
11	t _{WR}	Write Enable HIGH to Address Do Not Care		0		0		0		0		ns
12	t _{WZ}	Write Enable LOW to Output in Hi-Z	(Notes 4, 5)	0	15	0	15	0	20	0	25	ns
13	t _{DW}	Data In Valid to Write Enable HIGH		20		20		25		35		ns
14	t _{DH}	Data Hold Time		5		5		5		5		ns
15	t _{AS}	Address Valid to Write Enable LOW		0		0		0		0		ns
16	t _{CW}	Chip Enable LOW to Write Enable HIGH	(Note 2)	30		35		45		65		ns
17	t _{OW}	Write Enable HIGH to Output in Low-Z	(Notes 4, 5)	0		0		0		0		ns
18	t _{AW}	Address Valid to End of Write		30		35		45		65		ns

SWITCHING TEST CIRCUITS

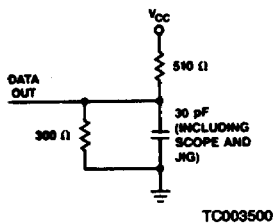



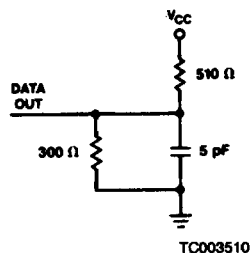



A. Output Load



B. Output Load for t_{HZ}, t_{LZ}, t_{OW}, t_{WZ}

SWITCHING WAVEFORMS

KEY TO SWITCHING WAVEFORMS

WAVEFORM	INPUTS	OUTPUTS
 	MUST BE STEADY	WILL BE STEADY
	MAY CHANGE FROM H TO L	WILL BE CHANGING FROM H TO L
	MAY CHANGE FROM L TO H	WILL BE CHANGING FROM L TO H
	DON'T CARE; ANY CHANGE PERMITTED	CHANGING; STATE UNKNOWN
	DOES NOT APPLY	CENTER LINE IS HIGH IMPEDANCE "OFF" STATE

KS000010

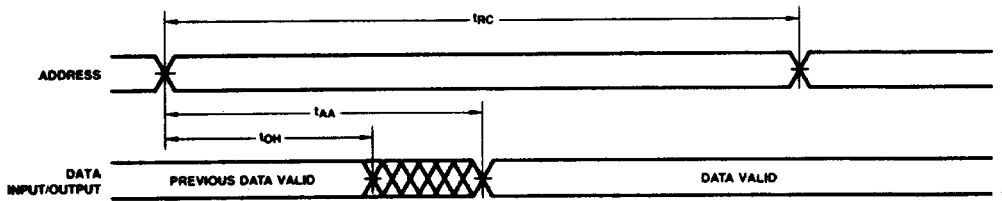

WF021270

Read Cycle No. 1 (\overline{WE} HIGH, \overline{CE} LOW)

4

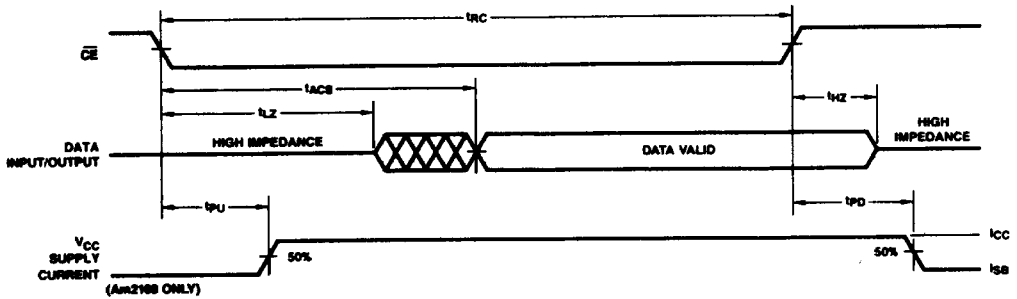

WF021280

Read Cycle No. 2 (\overline{WE} HIGH, Address Valid Prior to \overline{CE} Transition to LOW)

SWITCHING WAVEFORMS (Cont'd.)

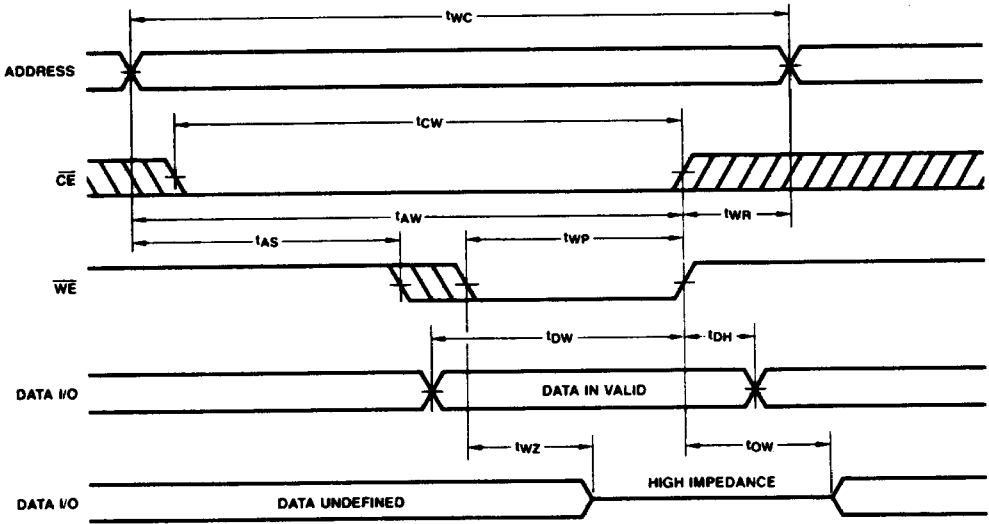

WF021870

Write Cycle No. 1 (\overline{WE} Controlled)

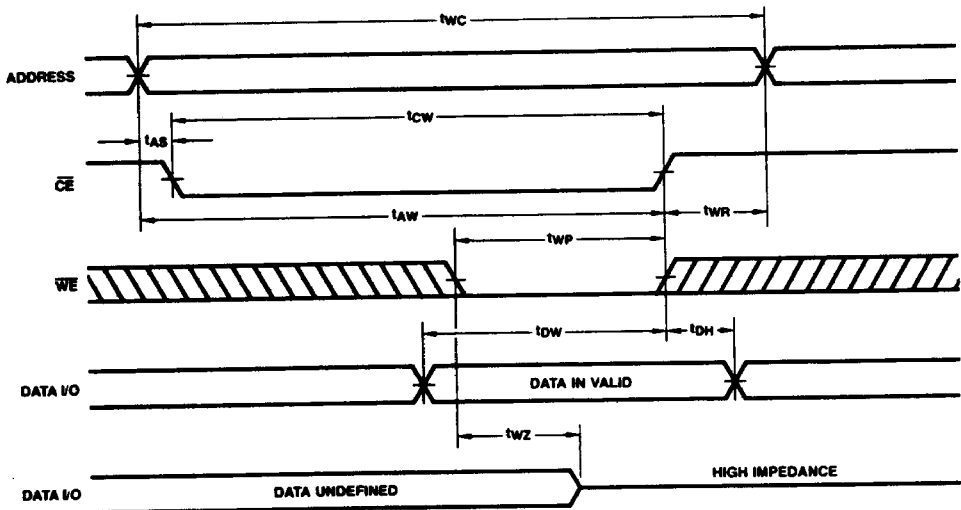

WF021300

Write Cycle No. 2 (\overline{CE} Controlled)

Note: If \overline{CE} goes HIGH simultaneously with \overline{WE} HIGH, the output remains in a high-impedance state.

TYPICAL PERFORMANCE CURVES

**Supply Current
versus Supply Voltage**

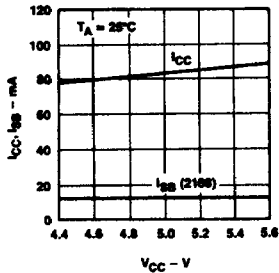

OP001980

**Supply Current
versus Ambient Temperature**

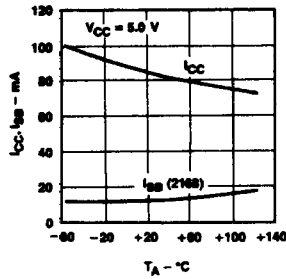

OP001990

**Output Source Current
versus Output Voltage**

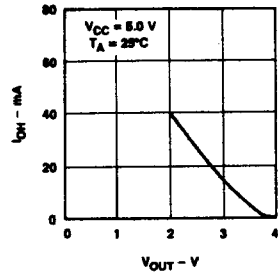

OP002000

**Normalized Access Time
versus Supply Voltage**

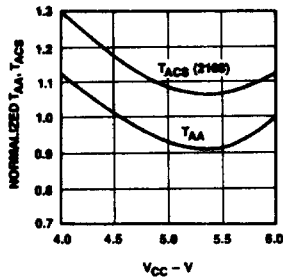

OP002010

**Normalized Access Time
versus Ambient Temperature**

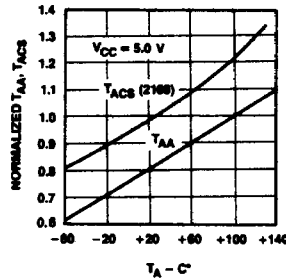

OP002020

**Output Sink Current
versus Output Voltage**

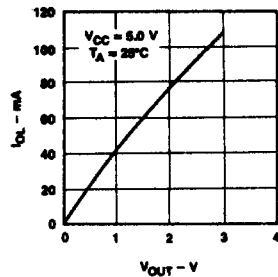

OP002030

**Typical Power-On Current
versus Power Supply**

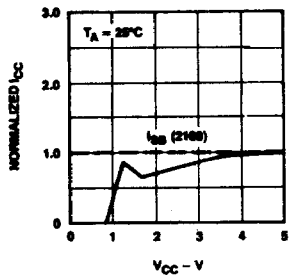

OP002040

**Access Time Change
versus Input Voltage**

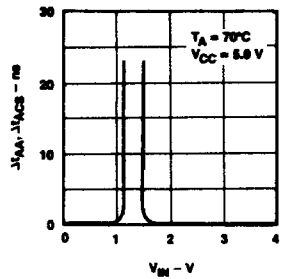

OP002050

**Access Time Change
versus Output Loading**

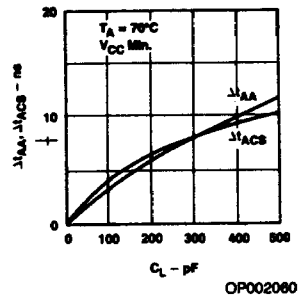

OP002060