

VOLTAGE COMPARATOR

■ GENERAL DESCRIPTION

The NJM319 is precision high speed dual comparator fabricated on a single monolithic chip. It is designed to operate over a wide range of supply voltages down to single 5V logic and ground. The uncommitted collector of the output stage makes the NJM319 compatible with RTL, DTL and TTL as well as capable of driving lamps and relays at currents up to 25mA.

■ FEATURES

- Operating Voltage (+5V~+36V)
- Single Supply Operation
- Response Time (80ns typ.)
- Output Current (25mA @ Sink Current)
- Package Outline DIP14, DMP14, SSOP14
- Bipolar Technology

■ PACKAGE OUTLINE

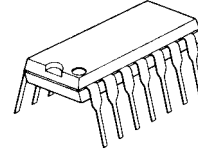

NJM319D

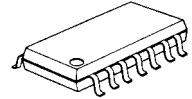

NJM319M



NJM319V

■ PIN CONFIGURATION

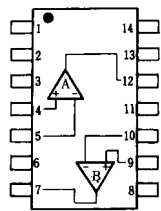

NJM319D
NJM319M
NJM319V

PIN FUNCTION

1. NC
2. NC
3. (2) A GND
4. (3) A +INPUT
5. (4) A -INPUT
6. (5) V⁻
7. (6) B OUTPUT
8. (7) B GND
9. (8) B +INPUT
10. (9) B -INPUT
11. (10) V⁺
12. (1) A OUTPUT
13. NC
14. NC

■ EQUIVALENT CIRCUIT (1/2 Shown)

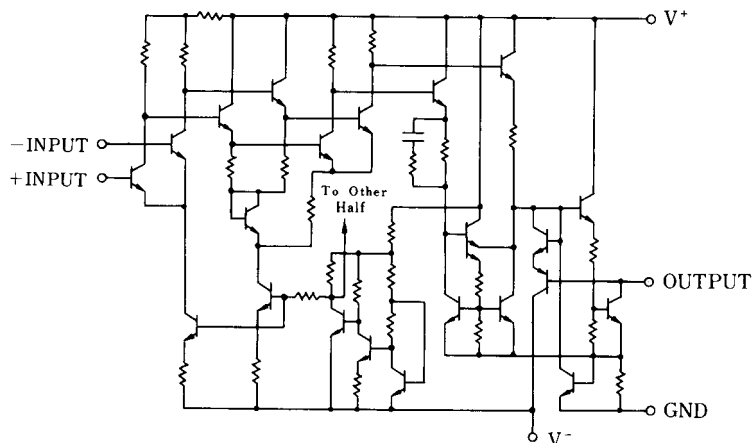

NJM319

■ ABSOLUTE MAXIMUM RATINGS

(Ta=25°C)

PARAMETER	SYMBOL	RATINGS	UNIT
Supply Voltage	V^+V^-	36	V
Input Voltage	V_{IC}	± 15 (note1)	V
Differential Input Voltage	V_{ID}	± 5 (note2)	V
Power Dissipation	P_D	(DIP14) 500 (DMP14) 300 (SSOP14) 300	mW
Output to Negative Supply Voltage	ΔV_{O-N}	36	V
GND to Negative Supply Voltage	ΔV_{G-N}	25	V
GND to Positive Supply Voltage	ΔV_{G-P}	18	V
Operating Temperature Range	T_{opr}	-40~+85	°C
Storage Temperature Range	T_{stg}	-40~+125	°C

(note1) For supply voltage less than $\pm 15V$, the absolute maximum input voltage is equal to the supply voltage.

(note2) Do not apply voltage more than 5V at the point between +INPUT and -INPUT.

■ ELECTRICAL CHARACTERISTICS

(Ta=25°C, $V^+V^- = \pm 15V$)

PARAMETER	SYMBOL	TEST CONDITION	MIN.	TYP.	MAX.	UNIT
Input Offset Voltage	V_{IO}	$R_S \leq 5k\Omega$	-	2.0	8.0	mV
Input Offset Current	I_{IO}		-	80	200	nA
Input Bias Current	I_B		-	250	1000	nA
Voltage Gain	A_V		78	92	-	dB
Response Time	t_R	V_{IN} : 100mV Step Input 5mV Over Drive	-	80	-	ns
Saturation Voltage	V_{SAT}	$V_{IN} \leq 10mV, I_{SINK} = 25mA$	-	0.75	1.5	V
Output Leakage Current	I_{LEAK}	$V_{IN} \geq 10mV, V^- = GND = 0V, V_{OUT} = 35V$	-	0.2	10	μA
Positive Supply Current	I^+1	$V^+ = 5V, V^- = 0V$	-	4.3	-	mA
Positive Supply Current	I^+2		-	8	12.5	mA
Negative Supply Current	I^-		-	3	5	mA

■ TYPICAL CHARACTERISTICS

Input Bias Current vs. Temperature

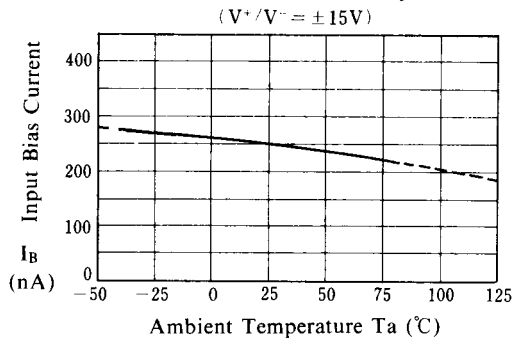

Input Offset Voltage vs. Temperature

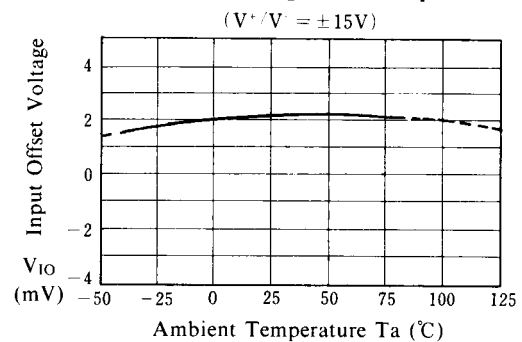

Operating Current vs. Operating Voltage

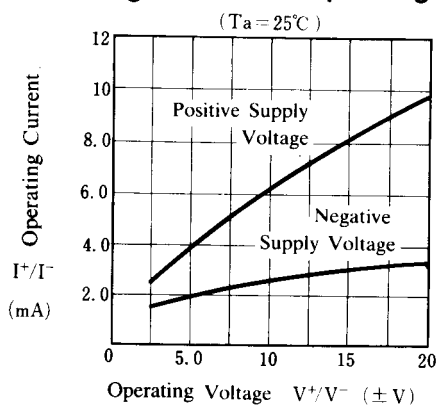

Transfer Function

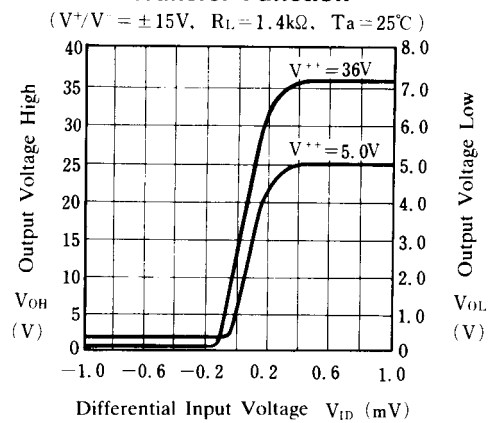

Response Time for Various Input Overdrives

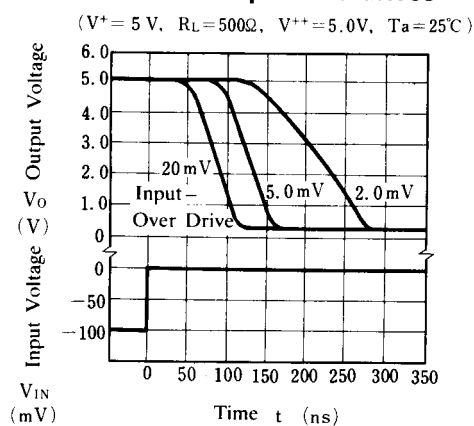

Response Time for Various Input Overdrives

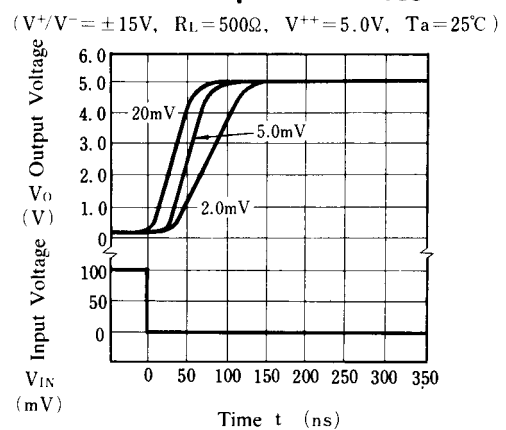

NJM319

■ TYPICAL CHARACTERISTICS

Response Time for Various Input Overdrives

($V^+/V^- = \pm 15V$, $R_L = 500\Omega$, $V^{++} = 5.0V$, $T_a = 25^\circ C$)

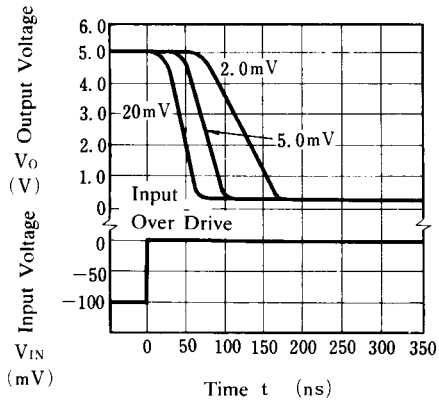

Response Time for Various Input Overdrives

($V^+ = 5V$, $R_L = 500\Omega$, $V^{++} = 5V$, $T_a = 25^\circ C$)

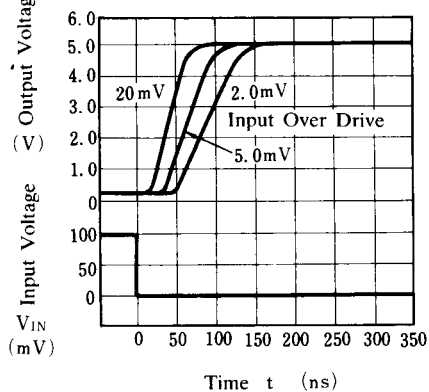

■ TYPICAL APPLICATIONS

Relay Driver

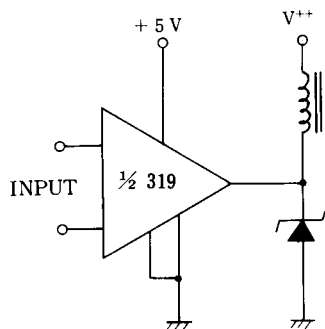

Window Detector

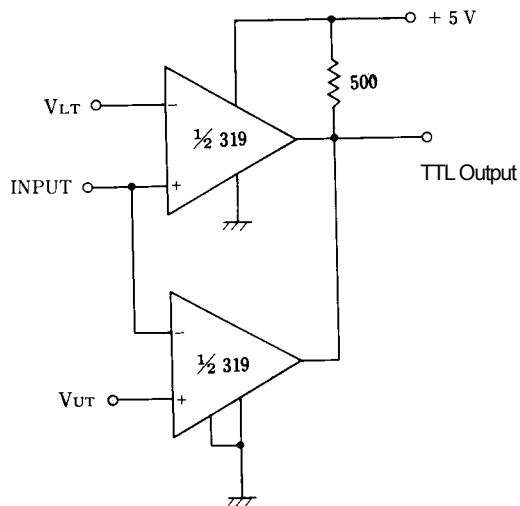

[CAUTION]

The specifications on this databook are only given for information, without any guarantee as regards either mistakes or omissions. The application circuits in this databook are described only to show representative usages of the product and not intended for the guarantee or permission of any right including the industrial rights.