

 Dolby B Type Noise Reduction System with Recording/Playback Equalizer
Description

The CXA1897Q is an analog signal processing IC for tape recorders. It achieves whole processing operations for the recording and playback systems which include the Dolby B noise reduction function on a single chip. This IC supports 2 channels at each function.

Features

- Dolby B noise reduction supports 1.7 times normal speed.
- Recording/playback equalizer amplifier supports 1.7 times normal speed.
- Built-in comparator for AMS (automatic music sensor)
- Built-in AGC (automatic gain control) with amplifier for MPX filter.
- Playback equalizer outputs independently for DECK-A and DECK-B.
- Externally adjustable recording equalizer Gp and fp.
- Built-in Recording mute function.
- Double cassette dubbing system can be easily configured just with this IC.

Applications

All analog signal processing in cassette deck parts of tape recorders and compact music centers (Sankyo Seiki mfg. Co., Ltd. YK47R-KF202 or equivalent which has the same head type.)

Structure

Bipolar silicon monolithic IC

48 pin QFP (Plastic)

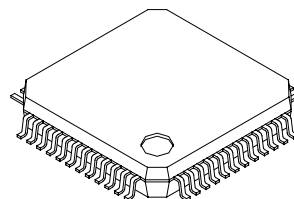
**Absolute Maximum Ratings** (Ta=25°C)

• Supply voltage	V _{CC}	12	V
• Operating temperature	T _{opr}	-20 to +75	°C
• Storage temperature	T _{stg}	-65 to +150	°C
• Allowable power dissipation	P _D	735	mW

Operating Conditions

• Supply voltage	V _{CC}	6.5 to 10.0	V
------------------	-----------------	-------------	---

* These ICs are available only to the licensees of Dolby Laboratories Licensing Corporation from whom licensing and applications information may be obtained.

* "Dolby" and the double D symbols are trade marks of Dolby Laboratories Licensing Corporation.

Sony reserves the right to change products and specifications without prior notice. This information does not convey any license by any implication or otherwise under any patents or other right. Application circuits shown, if any, are typical examples illustrating the operation of the devices. Sony cannot assume responsibility for any problems arising out of the use of these circuits.

Block Diagram

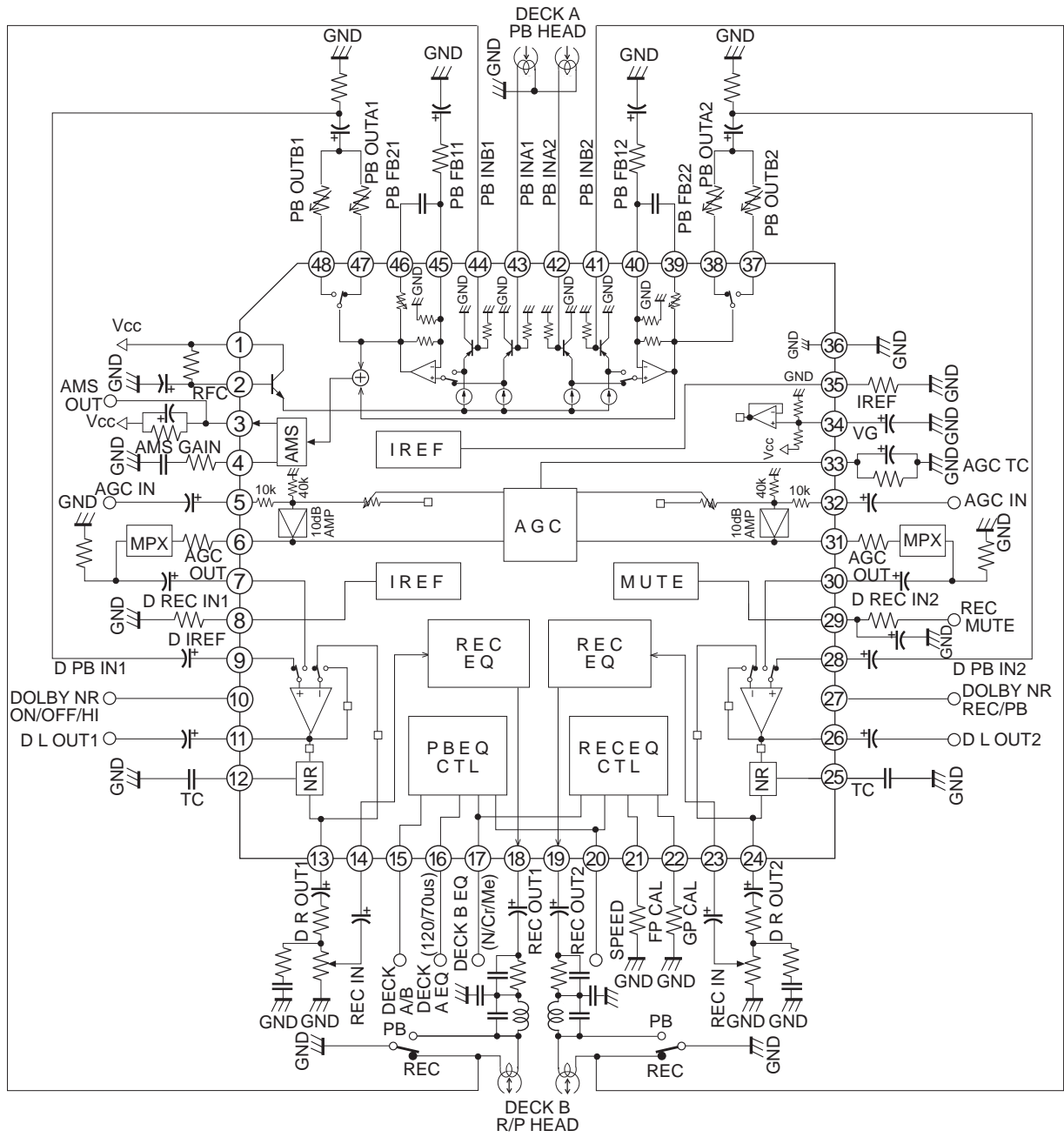

Pin Configuration

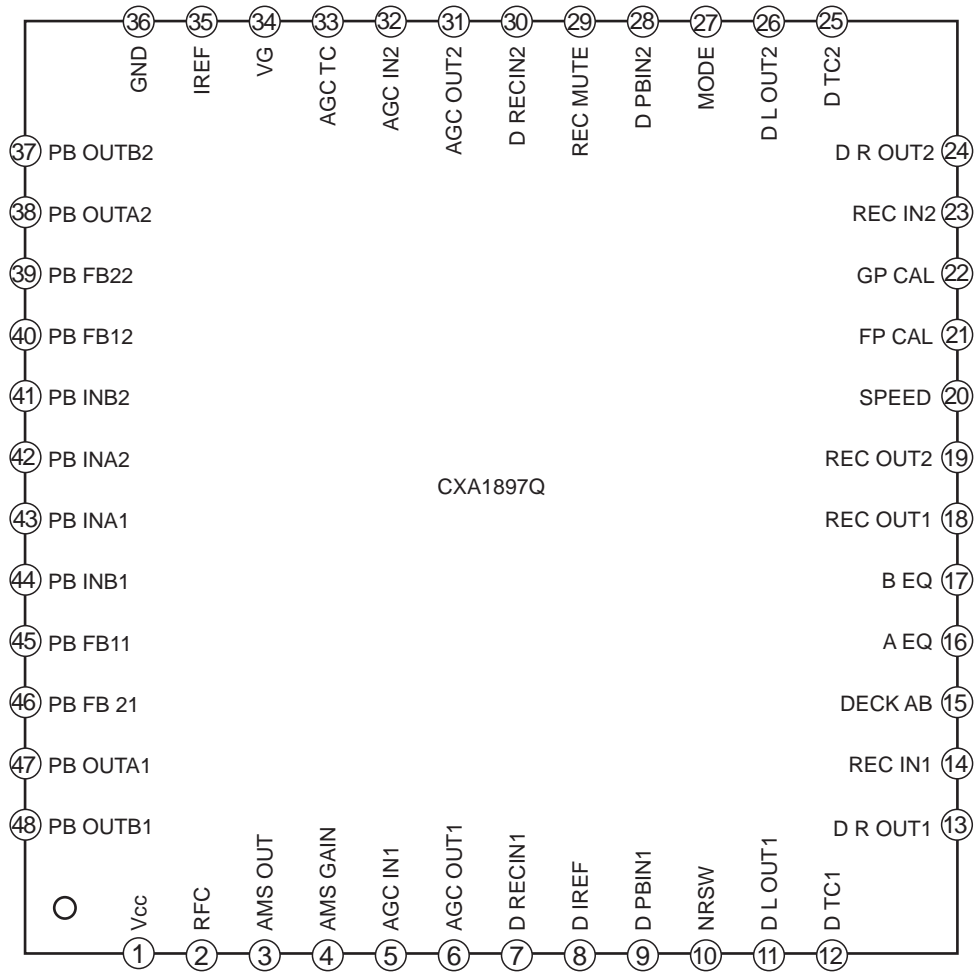

Pin Description

(Ta=25°C, Vcc=8 V, no signals)

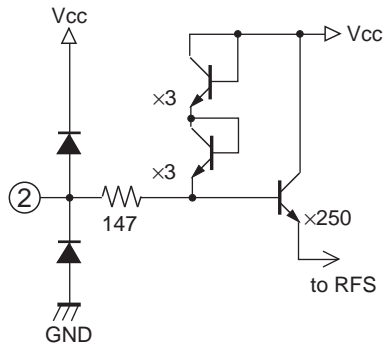
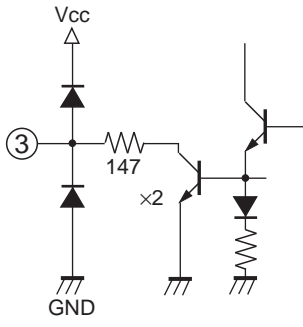
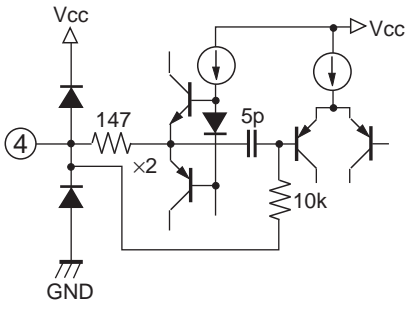
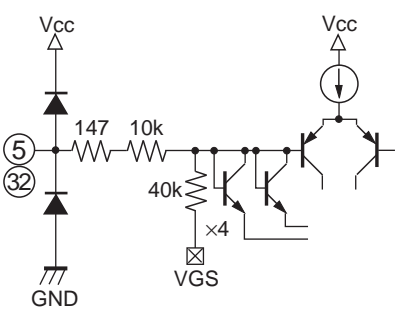
Pin No.	Symbol	DC voltage	I/O	I/O resistance	Equivalent circuit	Description
1	Vcc	8.0V	—	—		Power supply pin.
2	RFC	8.0V	—	—		Connects the resistor and capacitor for providing a ripple eliminated stable voltage in the power supply.
3	AMS OUT	8.0V	O	—		AMS output pin. Connects the resistor and capacitor which determine the attack and recovery time constants of the output to Vcc. No signal supplied → High level Signal supplied → Low level
4	AMS GAIN	2.8V	—	—		Connects the resistor which determines the AMS signal detection level.
5 32	AGC IN1 AGC IN2	4.0V	I	50kΩ		AGC signal input pin. The input resistance varies from 50kΩ to 10kΩ. AGC is applied when a signal of -30dB or more level is input to AGC. (Pin 33 external 47μF // 300kΩ)

Pin No.	Symbol	DC voltage	I/O	I/O resistance	Equivalent circuit	Description
6 31	AGC OUT1 AGC OUT2	4.0V	O	147Ω		AGC output pin.
7 30	D RECIN1 D RECIN2	4.0V	I	40kΩ		Dolby NR recording (encoding) input pin.
9 28	D PBIN1 D PBIN2	4.0V	I	40kΩ		Dolby NR playback (decoding) input pin.
8	D IREF	1.2V	—	—		Connects the 18kΩ resistor for providing the reference current of the Dolby NR section internal filter.
10	NRSW	2.5V (For OPEN)	I	53kΩ		Dolby NR ON/OFF switch. Low : ON Medium : OFF High : 1.7 times normal speed

Pin No.	Symbol	DC voltage	I/O	I/O resistance	Equivalent circuit	Description
11 26	D L OUT1 D L OUT2	4.0V	O	147Ω		Dolby NR line (decoding) output pin.
12 25	D TC1 D TC2	0.3V	—	—		Connects the capacitors (0.1μF) which determine the time constants of the input signal level detector.
13 24	D R OUT1 D R OUT2	4.0V	O	147Ω		Dolby NR recording (encoding) output pin.
14 23	REC IN1 REC IN2	4.0V	I	50kΩ		Recording equalizer input pin.

Pin No.	Symbol	DC voltage	I/O	I/O resistance	Equivalent circuit	Description
15 16 20 27	DECK AB A EQ SPEED MODE	—	I	—		<p>⑮ Playback input deck A/B selector switch Low : PB INA High : PB INB</p> <p>⑯ Deck A equalizer selector switch. Low : 120μs EQ High : 70μs EQ</p> <p>⑰ Recording/playback equalizer speed selector switch. Low : Normal speed High : High speed (1.7 times normal speed)</p> <p>⑱ Dolby NR mode selector switch. Low : Recording (encoding) High : Playback (decoding)</p>
17	B EQ	2.5V (For OPEN)	I	53kΩ		<p>Deck B equalizer selector switch. Low : Normal tape, 120μs EQ Medium : CrO₂ tape, 70μs EQ High : Metal tape, 70μs EQ</p>
18 19	REC OUT1 REC OUT2	4.0V	O	147Ω		Recording equalizer output.

Pin No.	Symbol	DC voltage	I/O	I/O resistance	Equivalent circuit	Description
21	FP CAL	1.2V	—	—		Connects the resistor to determine the high-band peak frequency of the recording equalizer. Reference setting resistance is 27kΩ.
35	IREF					Connects the 12kΩ resistor to determine each gain of the equalizers.
22	GP CAL	1.2V	—	—		Connects the resistor to determine the high-band peak gain of the recording equalizer. Reference setting resistance is 27kΩ.
29	REC MUTE	—	I	—		Recording mute ON/OFF selector switch. Low : Muting ON High : Muting OFF * Fader function can be achieved with an external time constant circuit.
33	AGC TC	0.0V	—	—		Connects the resistor and capacitor to determine the attack and recovery time constants of the AGC.
34	VG	4.0V	—	60kΩ		Signal reference voltage. Connects the capacitor for eliminating ripple.

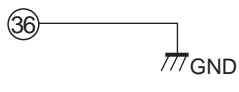
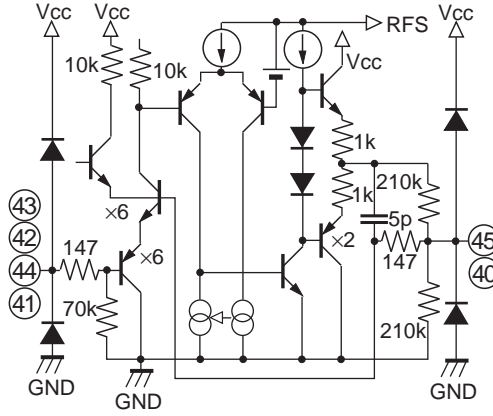
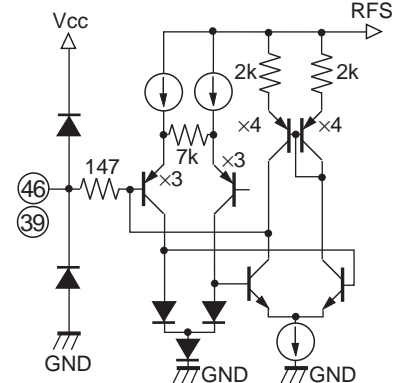
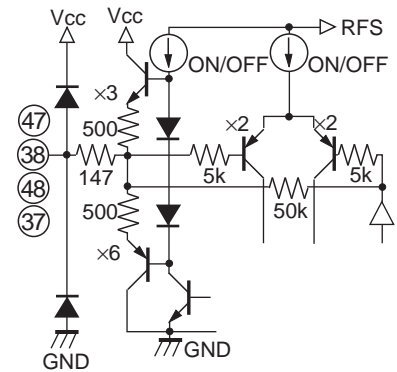
Pin No.	Symbol	DC voltage	I/O	I/O resistance	Equivalent circuit	Description
36	GND	0.0V	—	—		GND pin.
43 42 44 41	PB INA1 PB INA2 PB INB1 PB INB2	0.0V	I	70kΩ		Playback equalizer input pin.
45 40	PB FB11 PB FB12	1.4V	—	105kΩ		Playback equalizer negative feedback pin.
46 39	PB FB21 PB FB22	2.8V	—	—		Connects the capacitors which determine the 120μs, 70μs or other time constant of the playback equalizer.
47 38 48 37	PB OUTA1 PB OUTA2 PB OUTB1 PB OUTB2	2.8V	O	147Ω 50kΩ		Playback equalizer output pin. The pin selected by the deck AB switching has a low output resistance; the other pin has a 50kΩ output resistance.

Electrical Characteristics

(Ta=25°C, Vcc=8.0V)

Item	Conditions	Min.	Typ.	Max.	Unit
Operating voltage		6.5	8.0	10.0	V
Current consumption	No signal	15.0	19.5	24.0	mA

Item	Conditions	Min.	Typ.	Max.	Unit	
AGC	AGC on output level	1kHz, -25dBm, AGC TC external 47μF // 300kΩ	-24.0	-22.5	-20.0	dBm
	AGC on channel balance	1kHz, -15dBm, AGC TC external 47μF // 300kΩ	-2.0	0.0	2.0	dB
	AGC on distortion	1kHz, 0dBm, AGC TC external 47μF // 300kΩ	—	0.1	1.5	%

Item	Conditions	Min.	Typ.	Max.	Unit
AMS No signal detection level	AMS GAIN=4.7kΩ, 1kHz Reference output level for PB equalizer system (-25.0dBm)	—	—	-23.0	dB

Item	Conditions	Min.	Typ.	Max.	Unit	
Playback equalizer amplifier block	120μs NORM mode frequency characteristics	f=315Hz, Vin=-70dBm reference level	-27.0	-25.0	-23.0	dBm
		f=2.7kHz, Vin=-58.5dBm, against 315Hz	-1.5	-0.1	1.5	dB
	70μs NORM mode frequency characteristics	f=4.5kHz, Vin=-53.8dBm, against 315Hz	-1.5	0.3	1.5	dB
	120μs HIGH mode frequency characteristics	f=5.3kHz, Vin=-52.5dBm, against 315Hz	0.1	1.3	3.1	dB
	70μs HIGH mode frequency characteristics	f=9.1kHz, Vin=-47.8dBm, against 315Hz	0.1	1.6	3.1	dB
	Signal handling	120μs-NORM mode, f=1kHz, R _L =2.7kΩ, THD+N=1%	-10.0	-6.0	—	dBm
	Total harmonic distortion	120μs-NORM mode, f=1kHz, R _L =2.7kΩ, Vin=-52dBm	—	0.3	0.7	%
	S/N ratio	120μs-NORM mode, R _g =2.2kΩ, "A" WTG filter	55	62	—	dB
Output offset voltage	120μs-NORM, R _g =70kΩ	2.40	2.70	3.20	V	

Item		Conditions	Min.	Typ.	Max.	Unit	
Recording equalizer amplifier block	Reference input level	NORM-NORM, 315Hz	-29.4	-27.9	-26.4	dBm	
	Reference output level	NORM-NORM, 315Hz	—	-10.0	—	dBm	
	S/N ratio	Rg=5.1k, "A"-WTG filter	57.0	60.6	—	dB	
	Signal handling	NORM-NORM, R _L =2.7kΩ, 1kHz, THD=1%	8.0	8.8	—	dB	
	Total harmonic distortion	NORM-NORM, R _L =2.7kΩ, 1kHz, 0dB	—	0.2	0.5	%	
	Output offset voltage	NORM-NORM	3.6	4.0	4.4	V	
	NORM-NORM mode frequency characteristics	3kHz, -20dB	Against NORM-NORM mode at 315Hz, -20dB	-1.3	-0.2	1.1	dB
		8kHz, -20dB		3.7	5.7	7.3	dB
		12kHz, -20dB		10.4	13.4	16.4	dB
	CrO ₂ -NORM mode frequency characteristics	3kHz, -20dB	Against NORM-NORM mode at 315Hz, -20dB	1.8	3.0	4.2	dB
		8kHz, -20dB		6.7	8.4	9.7	dB
		12kHz, -20dB		13.2	15.8	18.2	dB
	METAL-NORM mode frequency characteristics	3kHz, -20dB	Against NORM-NORM mode at 315Hz, -20dB	3.3	4.5	5.7	dB
		8kHz, -20dB		5.9	7.4	8.9	dB
		12kHz, -20dB		11.3	13.7	15.8	dB
	NORM-HIGH mode frequency characteristics	5kHz, -20dB	Against NORM-NORM mode at 315Hz, -20dB	-0.7	0.2	1.7	dB
		15kHz, -20dB		8.3	10.5	12.3	dB
		20kHz, -20dB		13.5	16.7	19.5	dB
	CrO ₂ -HIGH mode frequency characteristics	5kHz, -20dB	Against NORM-NORM mode at 315Hz, -20dB	3.6	4.9	6.0	dB
		15kHz, -20dB		12.0	14.2	16.0	dB
		20kHz, -20dB		17.0	20.0	22.5	dB
	METAL-HIGH mode frequency characteristics	5kHz, -20dB	Against NORM-NORM mode at 315Hz, -20dB	4.9	6.1	7.3	dB
		15kHz, -20dB		10.5	12.4	14.0	dB
20kHz, -20dB		14.7		17.4	19.7	dB	
Maximum muting amount	NORM-NORM mode, 1kHz, +8dB		—	-100	-80	dB	
Muting characteristics	NORM-NORM mode, 1kHz, 2.0V (MUTE pin voltage)		-8.0	-5.6	-4.0	dB	

Item		Conditions	Min.	Typ.	Max.	Unit	
Dolby block	PB IN input sensitivity	PB, NR-OFF, 1kHz, D-R-OUT -10dBm	-32	-30	-28	dBm	
	REC IN input sensitivity	REC, NR-OFF, 1kHz, D-R-OUT -10dBm	-32	-30	-28	dBm	
	LINEOUT level	REC, NR-OFF, 1kHz, D-R-OUT -10dBm	-7	-6	5	dBm	
	Dolby level	DOLBY NR REC OUT pin (0dB)	—	-10	—	dBm	
	Encode boost 1-(1)	REC, NR-ON, 500Hz -25dB	1.4	3.0	4.4	dB	
	Encode boost 1-(2)	REC, NR-ON, 2kHz -25dB	5.5	6.3	8.5	dB	
	Encode boost 1-(3)	REC, NR-ON, 5kHz -25dB	3.9	5.0	6.9	dB	
	Encode boost 1-(4)	REC, NR-ON, 10kHz, -40dB	9.7	10.6	11.9	dB	
	Encode boost 1-(5)	REC, NR-ON, 10kHz 0dB	-1.1	0.7	1.9	dB	
	Encode boost 2-(1)	REC, NR-¥1.7 times, 850Hz -25dB	1.4	3.1	4.4	dB	
	Encode boost 2-(2)	REC, NR-¥1.7 times, 8.5kHz -25dB	3.9	5.1	6.9	dB	
	Encode boost 2-(3)	REC, NR-¥1.7 times, 17kHz -40dB	9.7	10.4	11.9	dB	
	Signal handling	REC, NR-OFF, 1kHz, THD+N=1%	14.0	15.5	—	dB	
	Total harmonic distortion (1)	REC, NR-OFF, 1kHz, 10dB	—	0.01	0.2	%	
	Total harmonic distortion (2)	REC, NR-ON, 1kHz, 10dB	—	0.03	0.2	%	
	Encode S/N ratio	REC, NR-ON, CCIR-filter	65.0	66.5	—	dB	
	Cross talk	(REC-PB)	PB, NR-OFF, 1kHz, 0dB	—	—	-65	dB
		(PB-REC)	REC, NR-OFF, 1kHz, 0dB	—	—	-60	dB
(REC 1ch-2ch)		REC, NR-OFF, 1kHz, 0dB	—	—	-55	dB	
(PB 1ch-2ch)		REC, NR-OFF, 1kHz, 0dB	—	—	-55	dB	

Item	Conditions	Min.	Typ.	Max.	Unit
Control voltage "L" level 1	NRSW (10PIN), B EQ (17PIN)	0.0	—	0.5	V
Control voltage "M" level 1	NRSW (10PIN), B EQ (17PIN)	2.2	—	2.8	V
Control voltage "H" level 1	NRSW (10PIN), B EQ (17PIN)	4.2	—	V _{cc}	V
Control voltage "L" level 2	REC MUTE (29PIN)	0.0	—	0.5	V
Control voltage "H" level 2	REC MUTE (29PIN)	3.5	—	V _{cc}	V
Control voltage "L" level 3	Other control pins	0.0	—	0.5	V
Control voltage "H" level 3	Other control pins	2.5	—	V _{cc}	V

Note)

NORM-NORM : NORMAL TAPE-NORMAL SPEED

CrO₂-NORM : CrO₂ TAPE-NORMAL SPEED

METAL-NORM : METAL TAPE-NORMAL SPEED

120μs-NORM : EQ=120μs-NORMAL SPEED

70μs-NORM : EQ=70μs-NORMAL SPEED

NORM-HIGH : NORMAL TAPE-HIGH SPEED

CrO₂-HIGH : CrO₂ TAPE-HIGH SPEED

METAL-HIGH : METAL TAPE-HIGH SPEED

120μs-HIGH : EQ=120μs-HIGH SPEED

70μs-HIGH : EQ=70μs-HIGH SPEED

**Electrical Characteristics
Test Circuit**

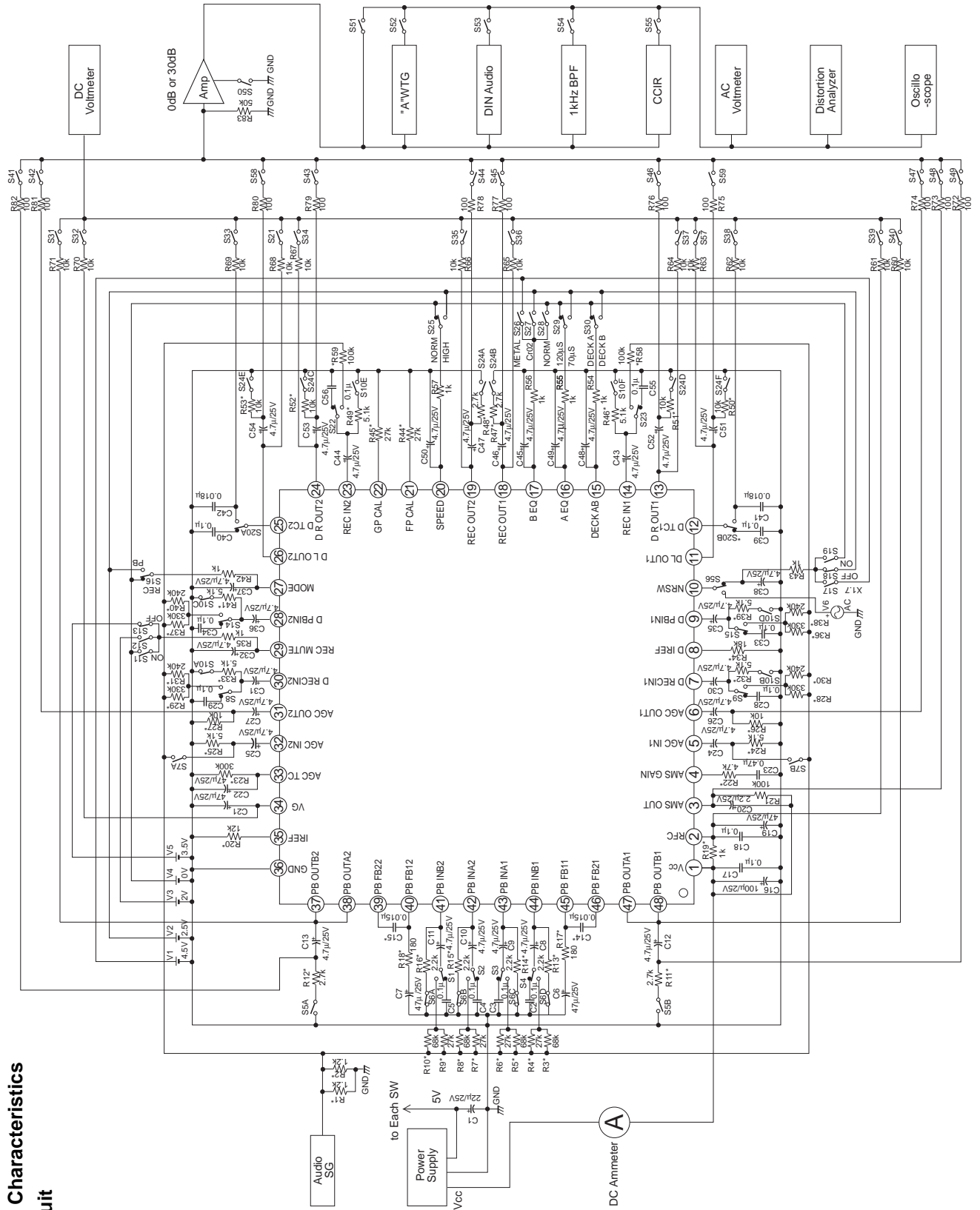

1. Description of Control Mode

(1) Playback and recording equalizers

1) Playback equalizer (120μs/70μs)

	A EQ (16 pin)			B EQ (17 pin)	
		L	H	L	M/H
DECK AB (15 pin)	L	120μs (A DECK)	70μs (A DECK)	A EQ control complied with	
	H	B EQ control complied with		120μs (B DECK)	70μs (B DECK)

2) Recording equalizer (Normal, CrO₂, Metal)

B EQ (17 pin)	L	M	H
REC MODE	Normal (Type I)	CrO ₂ (Type II)	Metal (Type IV)

3) Speed control

SPEED (20 pin)	L	H
Playback equalizer	Normal speed	1.7 times normal speed
Recording equalizer	Normal speed	1.7 times normal speed

4) Recording mute (29 pin)

Recording mute	Mute ON	-7dB attenuation	Mute OFF
Control voltage	GND ≤ VCL ≤ 0.5V	2.0V	3.5V ≤ VCH ≤ Vcc

The muting function is achieved by varying the gain of the recording equalizer amplifier as with an electric volume, depending on the DC voltage level supplied to the REC MUTE pin.

Mute ON/OFF and the AGC ON/OFF are interlocked.

Rec Mute	Mute ON	Mute OFF
AGC	OFF	ON

Notes for executing the fader function

The recording mute and the AGC are interlocked and if the AGC is turned OFF, the AGC output level is increased. Therefore, when the level of 3dB or more is input to the AGC to execute the fader function, the natural characteristics cannot be obtained.

Take care of setting the input level to the AGC.

5) FP CAL (21 pin)

The standard setting resistance is 27kΩ. However, fo (Hz) is reduced by increasing and increased by reducing this resistance.

6) GP CAL (22 pin)

The standard setting resistance is 27kΩ. However, the gain is increased by increasing or reduced by reducing this resistance.

(2) Dolby B noise reduction

1) Dolby NR input mode

MODE (27 pin)	L	H
Input	Rec In (7, 30 pin)	Pb In (9, 28 pin)
Dolby NR	Encoding	Decoding

2) Dolby NR ON/OFF/×1.7

NRSW (10 pin)	L	M	H
Dolby NR	ON	OFF	×1.7

2. AMS

(1) AMS output logic

Detection status	Signal detected	No signal detected
AMS OUT	L	H

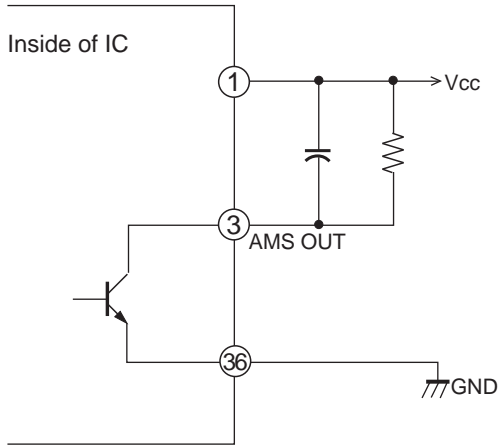

When the pins have been connected as shown on the left figure,

Low : Approximately 0.3V ($V_{CE(sat)}$ voltage)

High : V_{CC} (V)

(2) AMS level setting

With the reference output level (−25dBm) of the playback equalizer as 0dB, consider at how many decibels the AMS level is to be set.

$$\left\{ \frac{V_{peak}(PBOUT1) + V_{peak}(PBOUT2)}{2} \right\} \times 5 \leftrightarrow 5\mu A \text{ Compare}$$

R (external resistance)

↓

$$R = \frac{V_{peak}(PBOUT1) + V_{peak}(PBOUT2)}{2} \times 10^6 \text{ — ①}$$

Use formula ① to determine external resistance R.

Ex. 1) To set the detection level at 20dB lower than the reference (calculated on the assumption that 1ch=2ch)

$$-25\text{dBm} - 20\text{dB} = -45\text{dBm} = 6.16\text{mV}_{peak}$$

$$R = 6.16 \times 10^{-3} \times 10^6 \approx 6.2\text{k}\Omega$$

In which case, external resistance R is 6.2kΩ.

Ex. 2) To set the detection level at 30dB lower than the reference,

$$-25\text{dBm} - 30\text{dB} = -55\text{dBm} = 1.95\text{mV}_{peak}$$

$$R = 1.95 \times 10^{-3} \times 10^6 \approx 2\text{k}\Omega$$

In which case, external resistance R is 2kΩ.

(3) AMS band setting

By inserting a capacitor in series with the external resistor determined in (2), the direct current of the AMS is cut off. The lower end of the AMS band can be limited by adjusting the capacitor value because the cut-off frequency of the high-pass filter is determined by this external resistor and capacitor.

Application Circuit

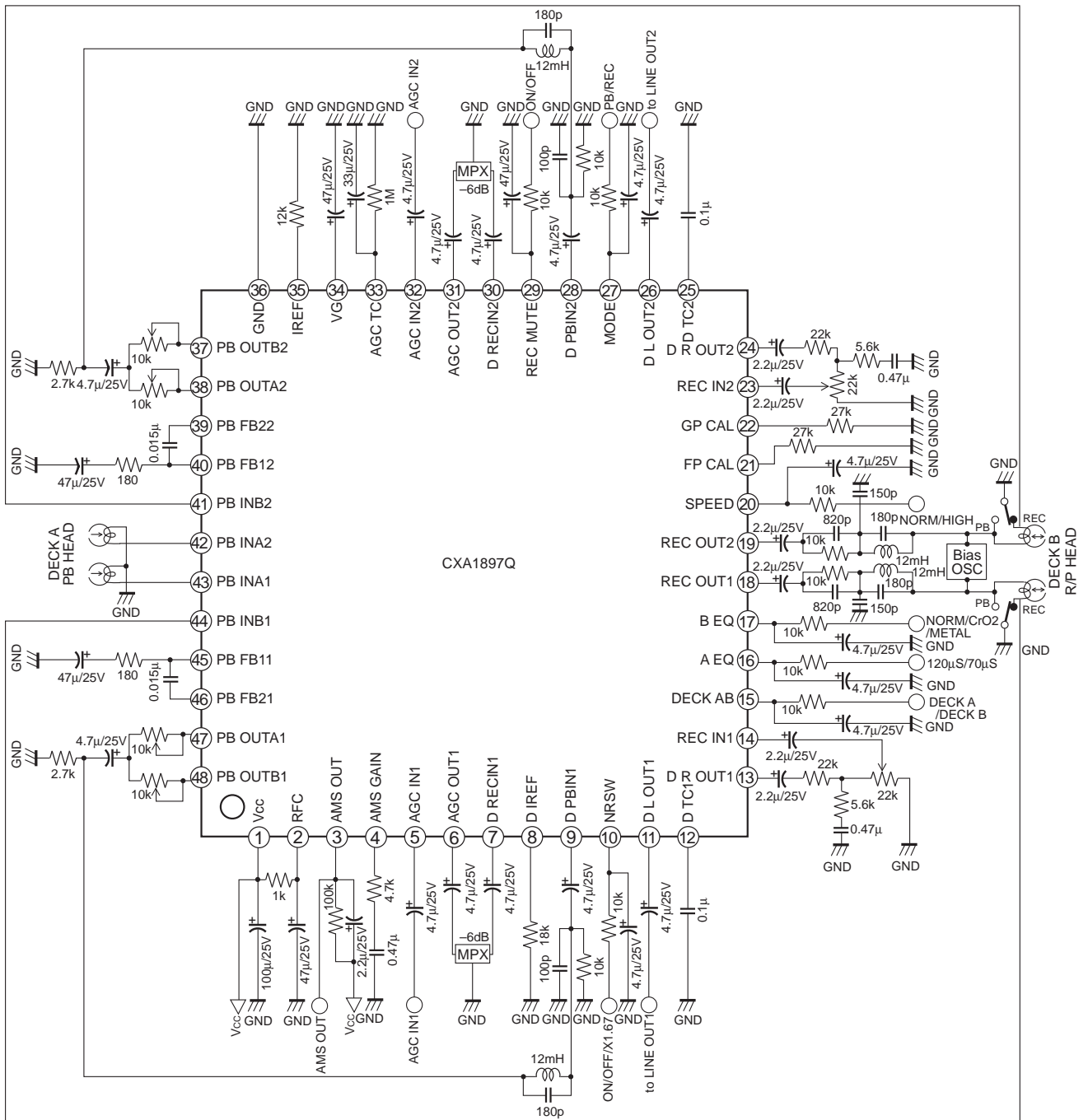

Application circuits shown are typical examples illustrating the operation of the devices. Sony cannot assume responsibility for any problems arising out of the use of these circuits or for any infringement of third party patent and other right due to same.

Examples of representative characteristics

Quiescent current vs. Supply voltage

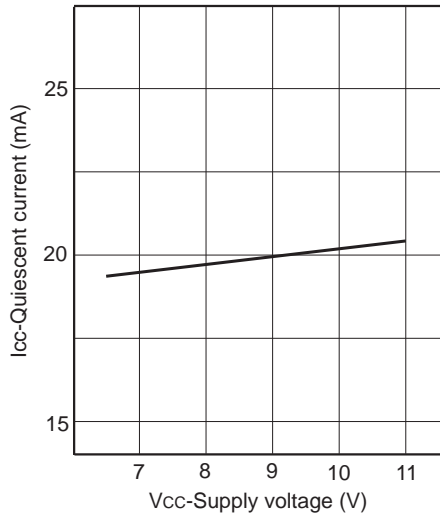

AGC output voltage characteristics

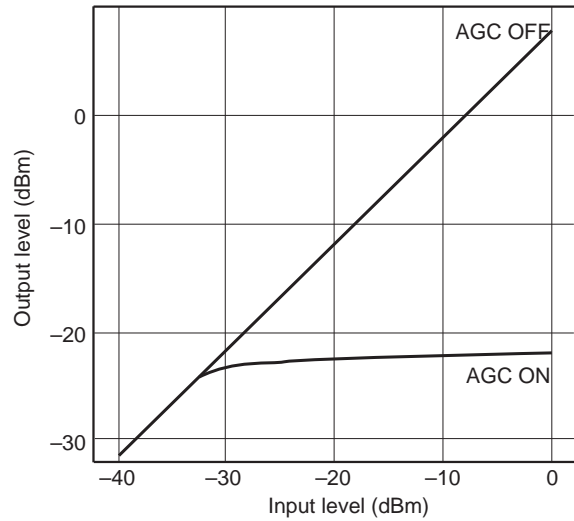

AGC total harmonic distortion

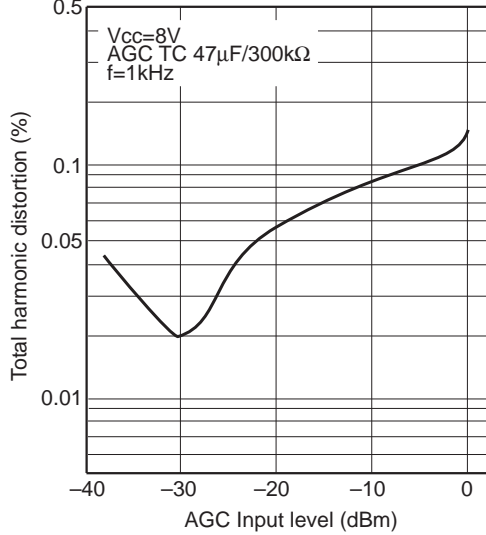

Play back equalizer total harmonic distortion

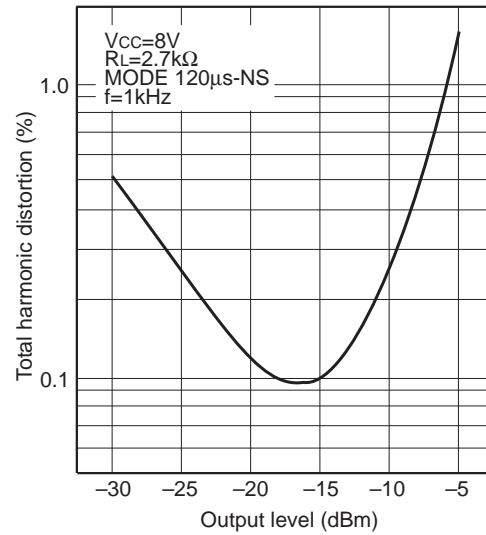

AMS no signal detection level frequency response

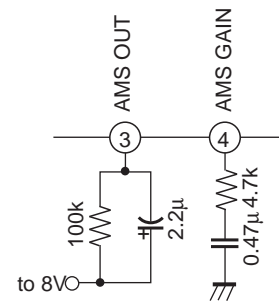
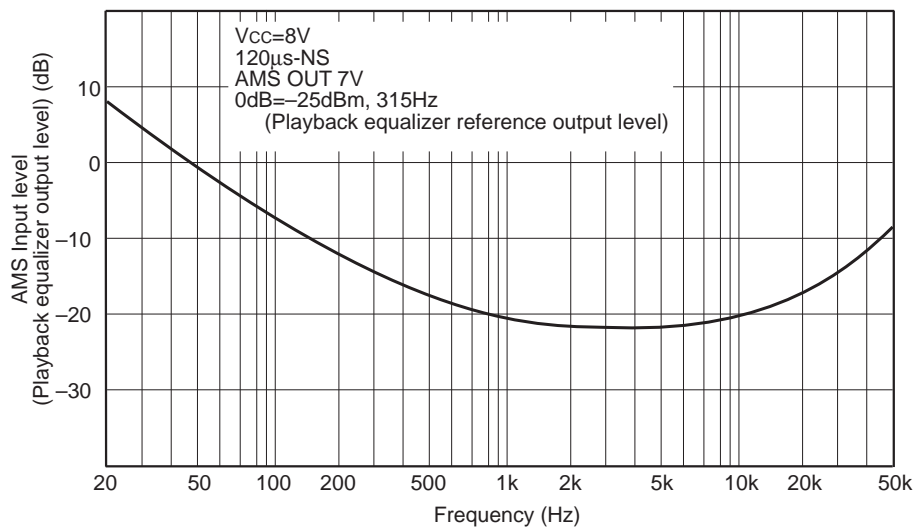

Playback equalizer frequency response

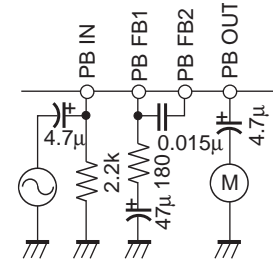
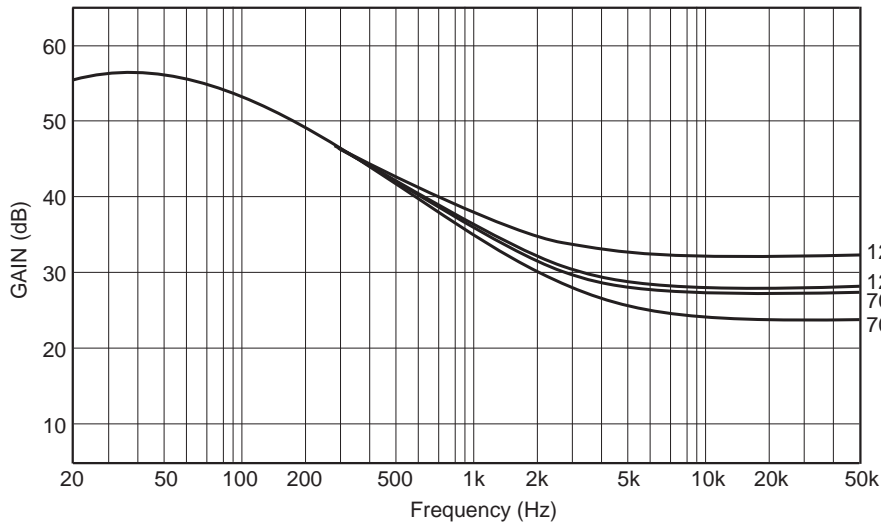

Recording equalizer frequency response

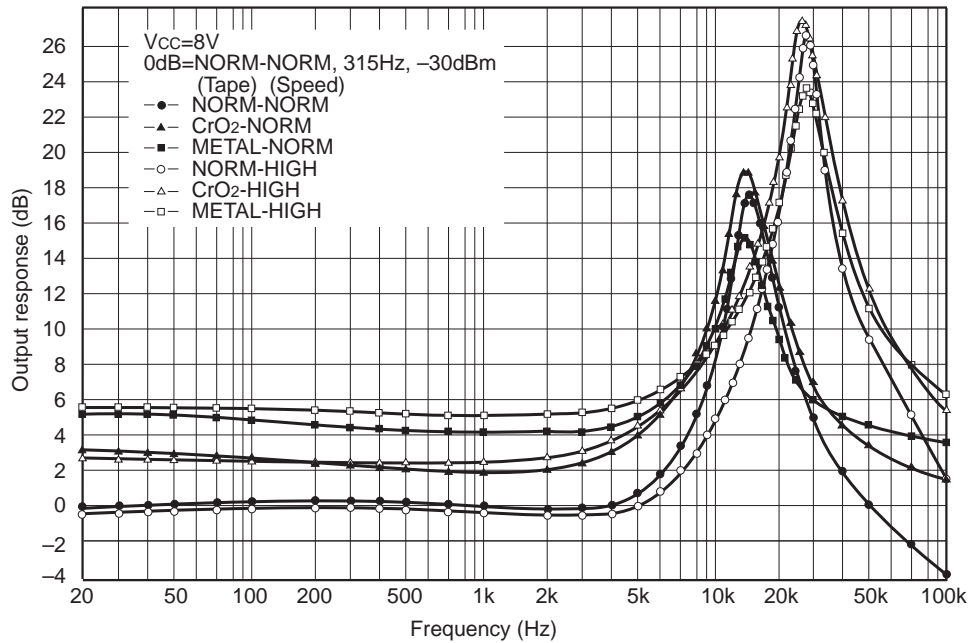

B type encode characteristics

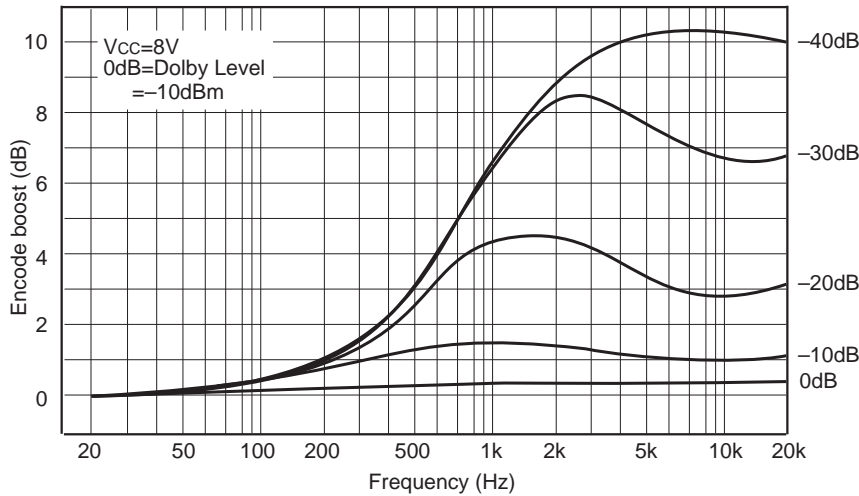

Recording equalizer total harmonic distortion

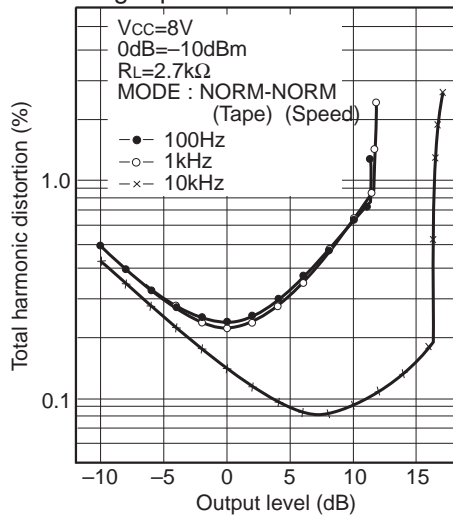

Output level vs. MUTE voltage

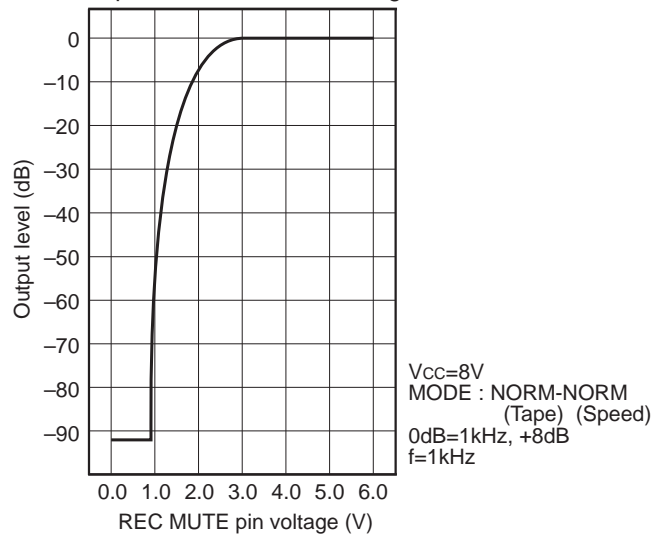

NR off total harmonic distortion

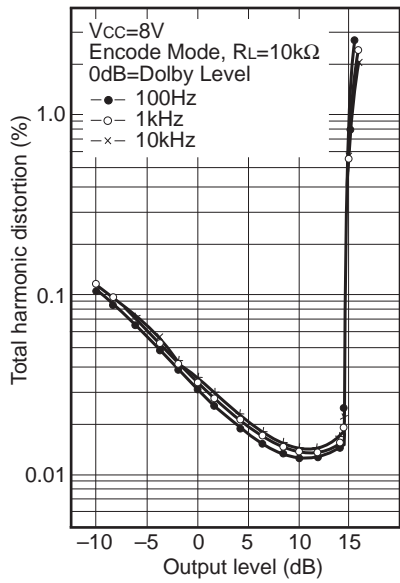

B type total harmonic distortion

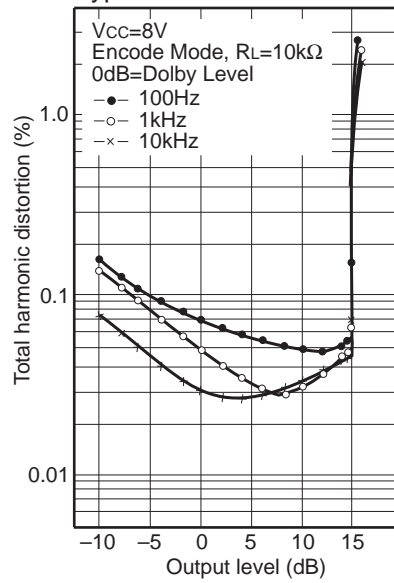

Package Outline Unit : mm

48PIN QFP (PLASTIC)

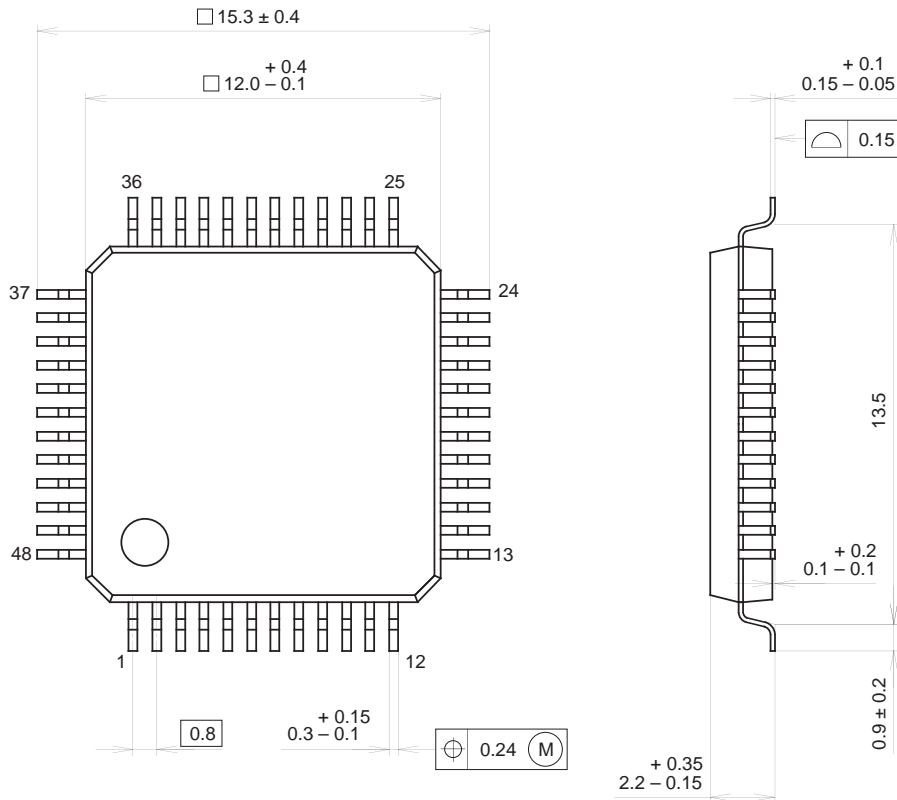

PACKAGE STRUCTURE

SONY CODE	QFP-48P-L04
EIAJ CODE	QFP048-P-1212
JEDEC CODE	—————

PACKAGE MATERIAL	EPOXY RESIN
LEAD TREATMENT	SOLDER / PALLADIUM PLATING
LEAD MATERIAL	42/COPPER ALLOY
PACKAGE MASS	0.7g

NOTE : PALLADIUM PLATING
 This product uses S-PdPPF (Sony Spec.-Palladium Pre-Plated Lead Frame).