



LA1193M, 1193V

High-Performance FM Front End for Car Radios

Overview

The LA1193M and LA1193V are front-end ICs developed for use in car radios. It incorporates an extremely wide dynamic range mixer and a new AGC system consisting of a dual-system wide-band AGC and a new keyed AGC to provide excellent interference suppression characteristics.

Functions

- Double-balance mixer
- Pin diode drive output
- Differential IF amplifier
- Dual-system wide-band AGC circuit
- Local buffer output
- 3D-AGC system
- FET gate drive AGC output
- IF amplifier gain control pin

Features

- Improved interference characteristics
 - Expanded mixer input dynamic range
Mixer input usable sensitivity: 15 dB μ
Mixer input I.M. QS: 90 dB μ
(The dynamic range has been increased by 6 dB over the earlier LA1175M.)
 - Development of a new wide-band AGC circuit
Improved interference characteristics for both near-channel interference and far-channel interference
Improved interference characteristics for the TV band
 - Development of a 3D-AGC system
The adjacent channel two-signal interference characteristics can be effectively improved without degrading the strong-field three-signal interference characteristics during keyed AGC operation.
- Improved stability design
 - AGC circuit local oscillator isolation
Measures were taken to prevent the deterioration of AMR, noise level, THD and other characteristics during AGC operation.
 - AGC circuit incorrect operation measures
The LA1193M provides methods to prevent incorrect operation due to local oscillator injection and loss of DC balance.

- Improved temperature characteristics
 - Conversion gain
 - AGC sensitivity
 - Antenna damping drive output current

Package Dimensions

unit: mm

3036B-MFP20

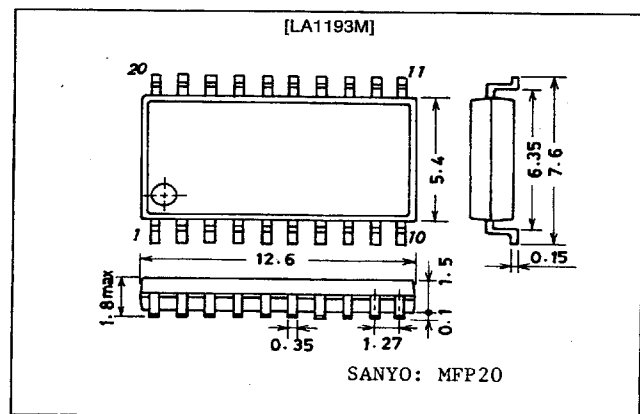

unit: mm

3179A-SSOP20

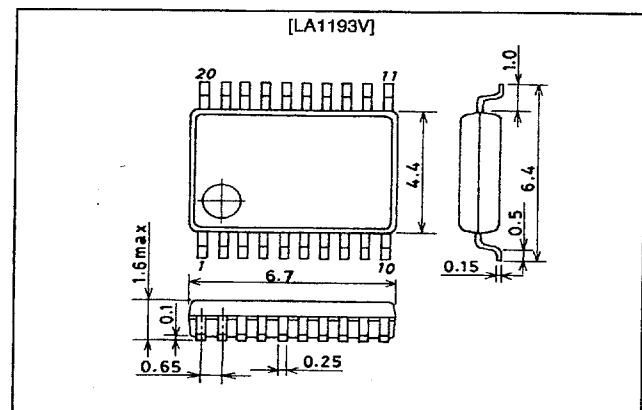

SANYO Electric Co., Ltd. Semiconductor Business Headquarters

TOKYO OFFICE Tokyo Bldg., 1-10, 1 Chome, Ueno, Taito-ku, TOKYO, 110 JAPAN

7997076 0016656 831

31097HA (OT)/61094TH(OT) A8-9997 No. 4715-1/21

LA1193M, 1193V

Specifications

Maximum Ratings at $T_a = 25^\circ\text{C}$

Parameter	Symbol	Conditions	Ratings	Unit
Maximum supply voltage	$V_{CC\text{ max}}$	V_{CC} for pins 5 and 17	9	V
	$V_{CC\text{ max mix}}$	V_{CC} for pins 10 and 11	15	V
Allowable power dissipation	$P_d\text{ max}$	LA1193M: ($T_a \leq 70^\circ\text{C}$) Mounted on a $41 \times 30 \times 1.1\text{ mm}^3$ glass-Epoxy board	500	mW
	$P_d\text{ max}$	LA1193V: ($T_a \leq 70^\circ\text{C}$) Mounted on a $23 \times 36 \times 1.6\text{ mm}^3$ glass-Epoxy board	500	mW
Operating temperature	T_{opr}	*	-40 to +85	$^\circ\text{C}$
Storage temperature	T_{stg}		-40 to +125	$^\circ\text{C}$

Note: * Connect a resistor (up to 10 k Ω) between pins 17 and 19.

Operating Conditions at $T_a = 25^\circ\text{C}$

Parameter	Symbol	Conditions	Ratings	Unit
Recommended supply voltage	V_{CC}		8.0	V
Operating supply voltage range	$V_{CC\text{ op}}$		7.6 to 9	V

Operating Characteristics at $T_a = 25^\circ\text{C}$, $V_{CC} = 8.0\text{ V}$, in the specified test circuit, $f = 88\text{ MHz}$, $f_{osc} = 77.3\text{ MHz}$

Parameter	Symbol	Conditions	Ratings			Unit
			min	typ	max	
Current drain	I_{CCO}	No input, $V_{CONT} = 0\text{ V}$	19	24	29	mA
Antenna damping current	ANT-DI	88 MHz, 100 dB μ , $V_{CONT} = 4.0\text{ V}$	7.0	9.5	12.5	mA
AGC high voltage	V_{AGC-H}	88 MHz, 0 dB μ , $V_{CONT} = 4.0\text{ V}$	7.6	7.9		V
AGC low voltage	V_{AGC-L}	88 MHz, 100 dB μ , $V_{CONT} = 4.0\text{ V}$		0.4	0.9	V
Saturation output voltage	V_{OUT}	88 MHz, 110 dB μ , $V_{CONT} = 4.0\text{ V}$	97	110		dB μ
-3 dB limiting sensitivity	Vi-Limit	88 MHz, 110 dB μ , $V_{CONT} = 4.0\text{ V}$	78	85	92	dB μ
Conversion gain	A. V	88 MHz, 75 dB μ , $V_{CONT} = 4.0\text{ V}$	98	101	104	dB μ
Local buffer output	$V_{OSC-Buff}$	No input, no modulation	105	109		dB μ
Narrow V_{AGC-ON}	V-NAGC	88 MHz, $V_{CONT} = 4.0\text{ V}$, at an input level such that $V_{AGC-OUT}$ is 2 V or less	73 (76)	80 (83)	87 (90)	dB μ
Wide V_{AGC-ON}	V-WAGC	88 MHz, $V_{CONT} = 0\text{ V}$, at an input level such that $V_{AGC-OUT}$ is 2 V or less	97	101	105	dB μ
3D-AGC-ON	V3D-AGC	88 MHz, V_{CONT} variable, with 95 dB μ being the V_{CONT} voltage input such that $V_{AGC-OUT}$ switches from high to low and 2.0 V as the V_{AGC} threshold value.	0.4	0.6	0.8	V

Note: Values in parenthesis are for LA1193V.

Application Circuit: Japan

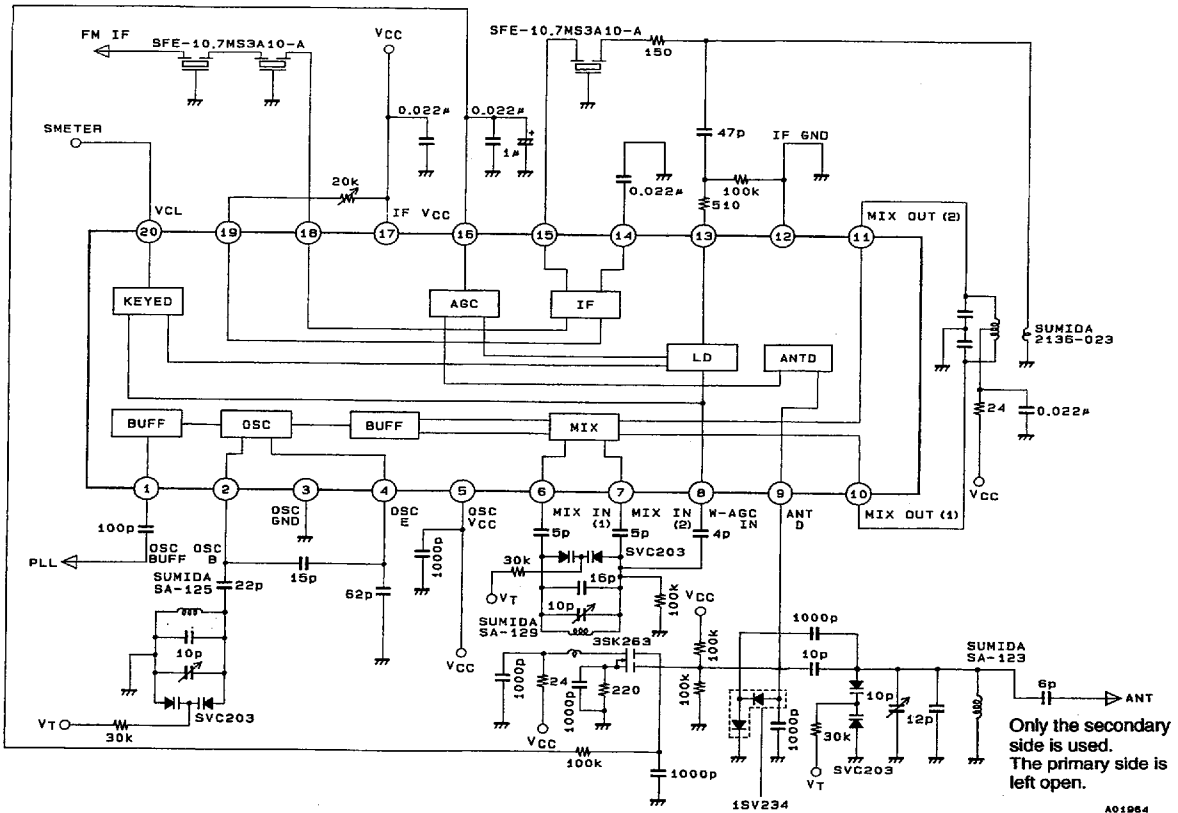

Coil Specifications

Unit (Resistance: Ω, Capacitance: F)

Coils Manufactured by Sumida Electronics

Japan band RF coil SA-129 or SA-143

Japan oscillator coil SA-125

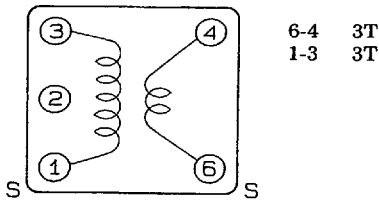

A00944

6-4 3T
1-3 3T

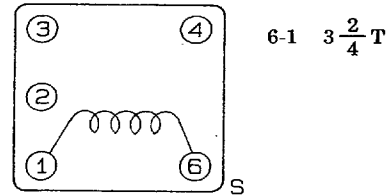

A00945

6-1 $3\frac{2}{4}$ T

Japan antenna coil SA-123 or SA-144

US band RF coil SA142 or SA-250

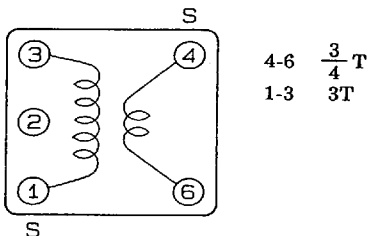

A00946

4-6 $\frac{3}{4}$ T
1-3 3T

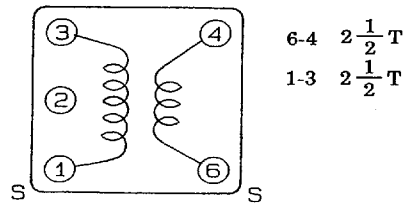

A00947

6-4 $2\frac{1}{2}$ T
1-3 $2\frac{1}{2}$ T

Continued on next page.

Continued from preceding page.

US band antenna coil SA-140 or SA-231

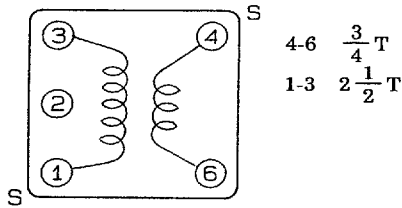

A00948

US band oscillator coil SA-278

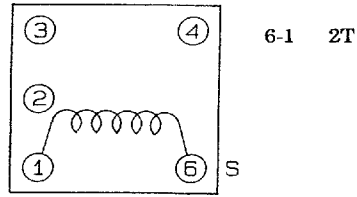

A00949

Mixer coil (for both bands) SA-266

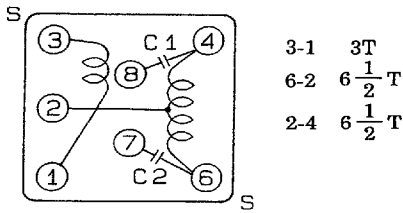

A00950

Pin Functions

Pin No.	Function	Equivalent circuit	Note
1	OSC BUFF	<p>A00951</p>	
2	OSC Tr. base	<p>A00952</p>	Colpitts oscillator

Continued on next page.

LA1193M, 1193V

Continued from preceding page.

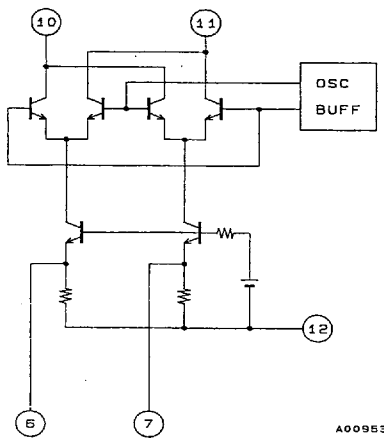
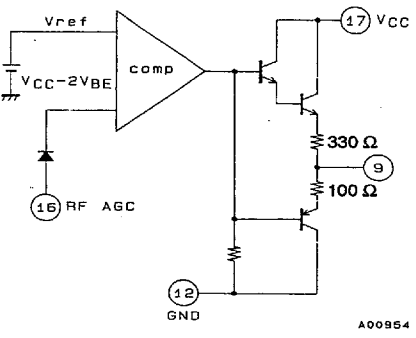
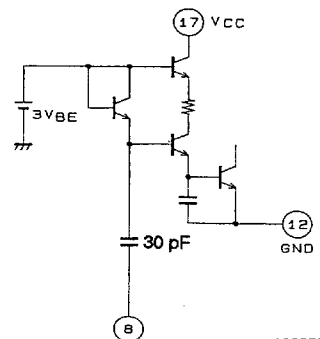
Pin No.	Function	Equivalent circuit	Note
<p>6 7 10 11</p>	<p>Mix input (1) Mix input (2) Mix out (1) Mix out (2)</p>		<p>Mixer input usable sensitivity 15 dBμ Mixer input I.M. QS 90.5 dBμ (6.5 dB higher than previous products) Conversion gain 15 dB Input impedance 25 Ω</p>
<p>9</p>	<p>Antenna damping drive output</p>		<p>I_{ANTD} = 10 mA</p>
<p>12</p>	<p>IF GND</p>		
<p>8</p>	<p>W-AGC input</p>		<p>Since the DC cut capacitor is provided on-chip in the pin internal circuit, we have taken steps to prevent incorrect AGC operation due to inter-pin leakage currents.</p>

Continued on next page.

LA1193M, 1193V

Continued from preceding page.

Pin No.	Function	Equivalent circuit	Note
13	N-AGC input	<p style="text-align: right;">A00956</p>	<p>Since the DC cut capacitor is provided on-chip in the pin internal circuit, we have taken steps to prevent incorrect AGC operation due to inter-pin leakage currents.</p>
14 15 18 19	IF AMP bypass IF AMP input IF AMP output IF AMP gain adjust	<p style="text-align: right;">A01965</p>	<p>IF gain: 25 dB Input and output impedances of 330 Ω The IF gain can be adjusted by inserting a resistor between pins 17 and 19. The gain is at its maximum when there is no resistor inserted.</p>
16	RF AGC output	<p style="text-align: right;">A00958</p>	<p>MOSFET Second gate control</p>
17	IF, AGC, V _{CC}		
20	Keyed AGC input	<p style="text-align: right;">A00959</p>	<p>Controls the narrow AGC.</p>

LA1193M, 1193V

1. Oscillator Circuit

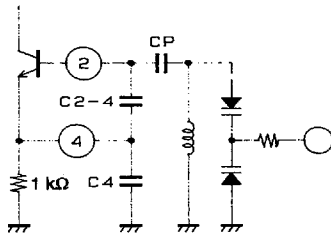

A00452

Steps were taken to prevent AMR degradation during earlier product type AGC operation, since the local oscillator block in this IC has independent Vd (pin 5) and ground (pin 3) connections.

This is a Colpitts oscillator and has the same structure as that used in earlier circuits. The oscillation level and intensity are changed by capacitors C₂₋₄, C₄ and C_p.

2. Local Oscillator Buffer Output

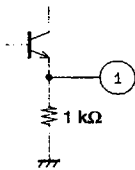

A00453

This buffer is an emitter follower circuit.

If desired, the buffer efficiency can be increased by inserting a resistor between pin 1 and ground to pass more current through the buffer transistor. However, this current must be limited so that P_{dmax} for the package is not exceeded.

3. Interference Characteristics

The LA1193M incorporates a newly developed 3D-AGC (triple dimension) circuit. This circuit allows three-signal interference characteristics (inter-modulation characteristics) and two-signal sensitivity suppression characteristics to be provided at the same time, a combination of characteristics previously thought difficult to achieve.

• Inter-Modulation Characteristics

The LA1193M prevents inter-modulation distortion by applying two wide-band AGC circuits.

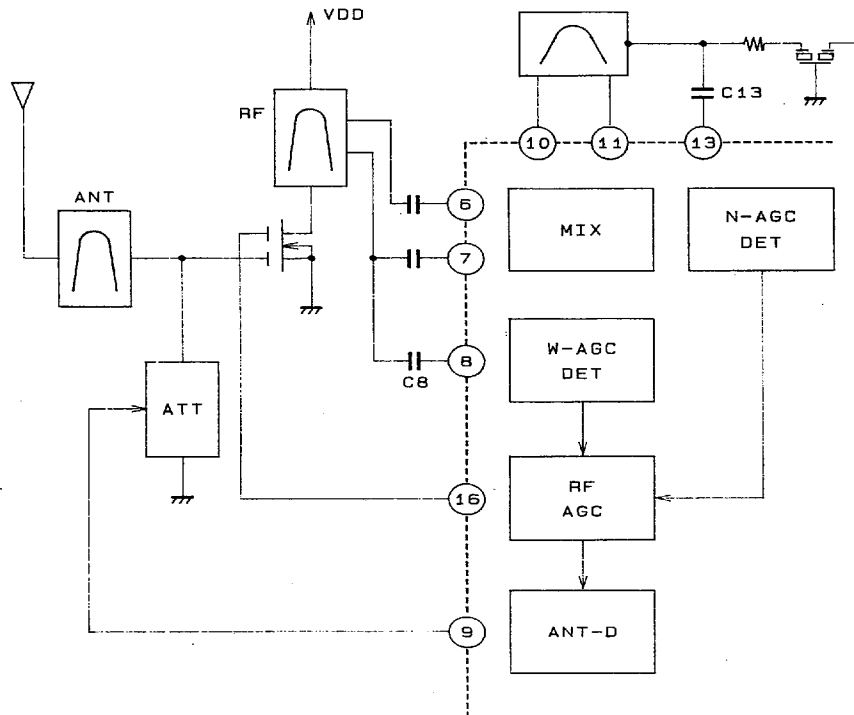

Figure 1

A00454

This double wide-band AGC system consists of two AGC circuits and a narrow AGC (pin 13 input, mixer input detection type) as shown in Figure 1. Figure 2 shows the antenna input frequency characteristics.

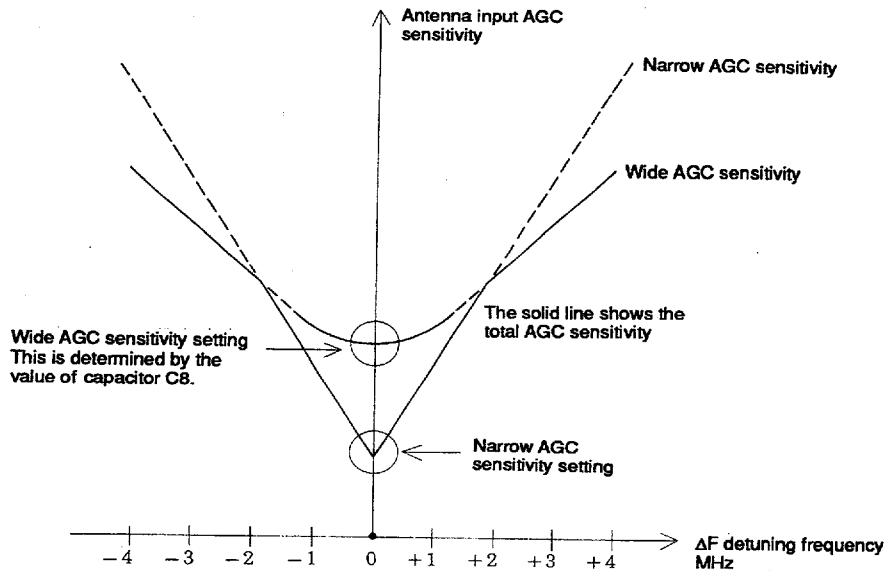

Figure 2 AGC Sensitivity Detuning Characteristics

Features of the Double Wide AGC System

- Since this is a mixer input detection wide-band AGC, it prevents the occurrence of intermodulation due to interfering stations with $\Delta f > 1$ MHz. (TV band interference prevention)
 - Since this system uses a narrow AGC at the same time, the wide AGC sensitivity can be lowered, thus preventing incorrect operation due to local oscillator injection.
 - Optimal sensitivities for any field conditions can be set, since the sensitivities of both the wide and narrow AGC systems can be set by changing the values of external components.
 - The input level of the desired station is limited by the narrow AGC. As a result, excessive levels are no longer input to the stages that follow the mixer and the beats at multiples of $10.7 \times A$ are reduced.
- **Two-Signal Sensitivity Suppression Characteristics**

Previously, keyed AGC systems were used to provide good intermodulation distortion and two signal sensitivity suppression characteristics at the same time. However, in previous keyed AGC systems, when the desired station would fade or drop out, the wide band AGC level would become essentially zero. As a result, the automatic station selection function would malfunction and blocking oscillation would occur in the presence of strong interfering stations. Thus keyed AGC systems were extremely hard to use in actual practice. Sanyo has developed a new AGC system (3D-AGC) that solves these problems and allows the construction of extremely simple application circuits. The LA1193M/V incorporates this AGC system.

What is the 3D-AGC system?

It is a system that determines the wide-band AGC level by using information that has the following three frequency characteristics.

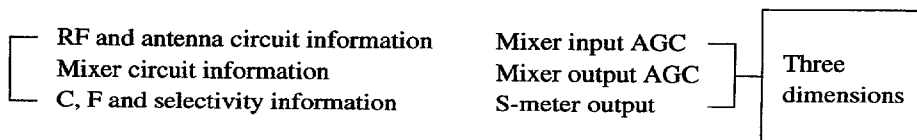

3D-AGC Features

Feature	Merit
The narrow AGC sensitivity, which operates for Δf of less than 1.5 MHz, is controlled independently according to the field strength of the desired station.	<ul style="list-style-type: none"> This is effective as a measure for mitigating two signal sensitivity suppression.
The narrow AGC sensitivity is controlled at V_{20} values under 2 V.	<ul style="list-style-type: none"> This allows two signal sensitivity suppression to be mitigated without deterioration in the three signal characteristics.
The wide AGC operates even when V_{20} is zero, i.e., when the desired station does not exist.	<ul style="list-style-type: none"> This allows the prevention of incorrect stopping on intermodulation signals during search. This allows the prevention of intermodulation occurring in the antenna and RF modulation circuits in the presence of strong interfering stations. Prevention of blocking oscillation due to AGC operation is also possible.
The N-AGC and the W-AGC sensitivities can be set independently.	<ul style="list-style-type: none"> This allows optimal settings to match the reception field conditions.
The system has two AGC systems, the N-AGC and the W-AGC.	<ul style="list-style-type: none"> Since the narrow AGC operates at the desired station and at adjacent stations, it is possible to reduce the wide AGC sensitivity. This prevents incorrect AGC operation due to local oscillator injection.

3D-AGC Sensitivity, Δf and V_{20} Characteristics

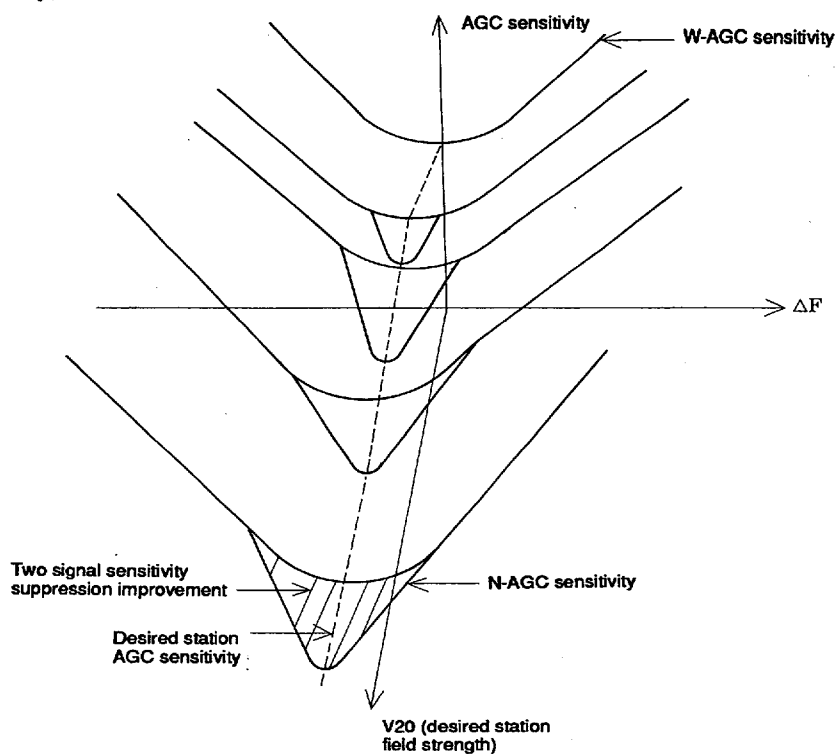

Figure 3 3D-AGC Sensitivity, Δf and V_{20} Characteristics

- The W-AGC sensitivity is determined by the antenna RF circuit selectivity independently of V_{20} .
- The N-AGC sensitivity is determined by the antenna, RF and mixer circuit total selectivity when V_{20} is 0.6 V or greater. It is determined by that selectivity and V_{20} when V_{20} is over 0.6 V.
- The improvement in two-signal sensitivity suppression is the shaded area in the total AGC sensitivity and corresponds to the section occupied by the N-AGC.

4. Mixer

The mixer circuit used in this IC is a balanced input/balanced output double balance mixer circuit.

• Input Format

Emitter input
Input impedance: 25 Ω

Optimization of the component geometry, emitter current and bias allow this circuit to achieve the following performance.

Mixer input usable sensitivity: 15 dBμ
Mixer input IMQS*: 90.5 dBμ

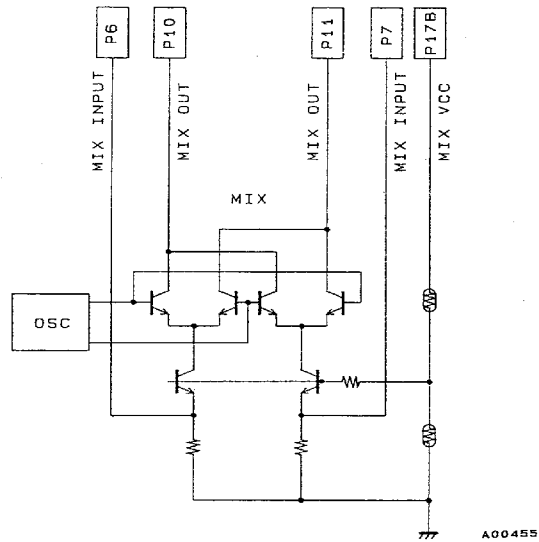

Figure 4 Mixer Circuit
(Improved by 6.0 dBμ over previous products.)

Note: * Mixer input IMQS is defined as follows:

- $f_r = 98.8 \text{ MHz}$, no input
- $f_{u1} = 98.8 \text{ MHz}$, 1 kHz, 30% modulation
- $f_{u2} = 99.6 \text{ MHz}$, no modulation

IMQS is the interference 1 and 2 input levels such that when an interference signal with the same level is input to the mixer and distortion occurs at the mixer, the generated IM output has a S/N ratio of 30 dB.

5. IF Amplifier

This IF amplifier is a single stage differential amplifier.

Specifications

Input impedance: 330 Ω
Output impedance: 330 Ω
Gain: 25 dB

Gain adjustment can be provided using either of the methods shown.

IF Gain adj

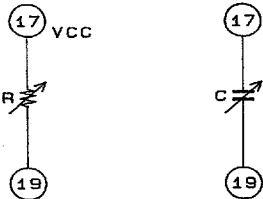

A01967

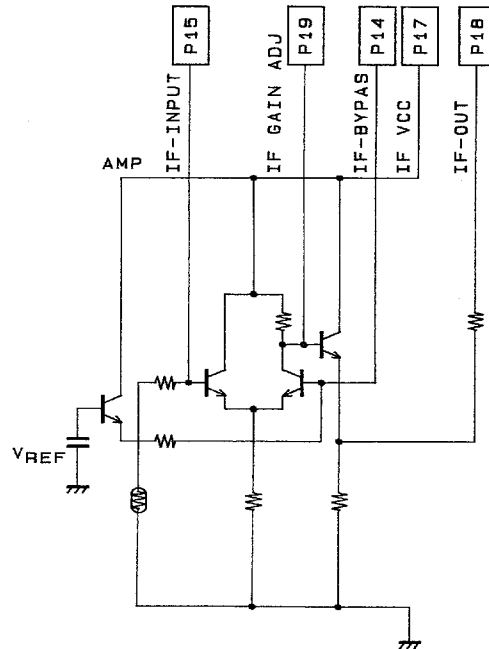

A01966

Temperature Characteristics

The LA1193M/V uses Vref temperature characteristics correction to hold the gain temperature characteristics to the low level of about 1 dB over the range -30 to +80°C.

6. AGC Circuit

The LA1193M/V uses pin diode antenna damping (pin 9) and MOSFET second gate voltage control (pin 16) for AGC. The AGC operating sequence is as follows:

Antenna damping (pin diode) → MOSFET second gate voltage control
 (attenuation) 20 dB (attenuation) dB

The above AGC sequence is used for the following reasons.

- Intermodulation distortion can occur if a signal of 110 dBμ or larger is input to the antenna circuit varactor diode. In such situations, if the AGC sequence was MOSFET second gate voltage control followed by pin diode antenna damping, as long as the receiver was not in a strong field where the 60 dB or higher AGC attenuation operates, input limitation due to the antenna circuit varactor diode would operate. Therefore, we feel that the AGC operating sequence employed is appropriate.
- Consider the problem of AGC loop stability. If the two AGC loops (the antenna damping AGC loop and the MOSFET second gate control AGC loop) operate, the AGC system would become unstable and have an excessively large influence on the transient response. Therefore the following structure cannot be used.
 MOSFET second gate control → antenna damping → MOSFET second gate control
 The AGC operating conditions are the same as those for the LA1175M.

• Narrow AGC circuit

Since the LA1193M/V's N-AGC (which detects the mixer output) is set to have a high sensitivity, care is required to avoid incorrect operation. In particular, there must be adequate separation from the local oscillator block on the printed circuit board pattern. Also, a resistor of at least 500 Ω must be inserted at the pin 13 input. A low-pass filter is formed by the insertion of this resistor. This low-pass filter prevents incorrect AGC operation due to the local oscillator.

- The AGC sensitivity setting can be changed by adjusting the value of the capacitor connected at pin 13. Although the AGC sensitivity can be lowered by increasing the value of the series resistor, caution is required since the AGC has its own frequency characteristics.

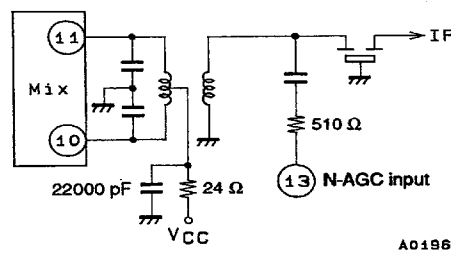

A01968

• Wide AGC circuit

The wide AGC sensitivity is set by the value of the capacitor on pin 8. However, since incorrect operation due to the local oscillator signal may occur if this capacitor is too large, its value must be chosen carefully.

• 3D-AGC

If the difference in sensitivity between the N-AGC and the W-AGC systems is too large during 3D-AGC operation, the S/N ratio can be degraded in the vicinity of the input where the AGC switches. Therefore, the 3D-AGC setting values must be selected carefully. Although this problem can be ameliorated by applying a time constant to pin 20, in principle, this S/N ratio degradation should be prevented by limiting the sensitivity difference between the two AGC systems.

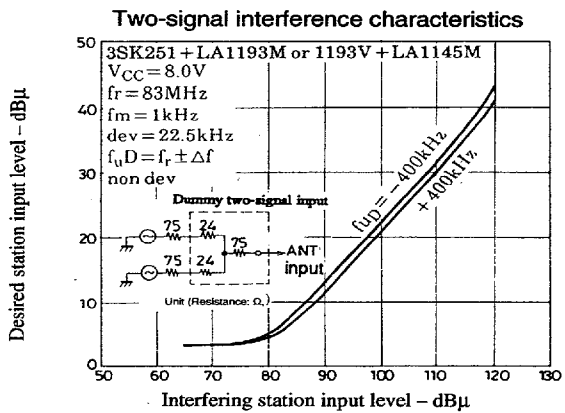
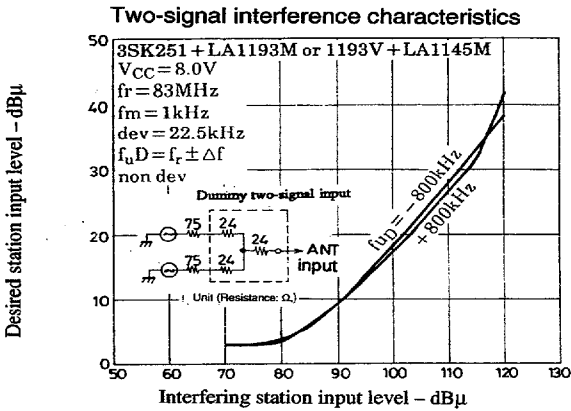
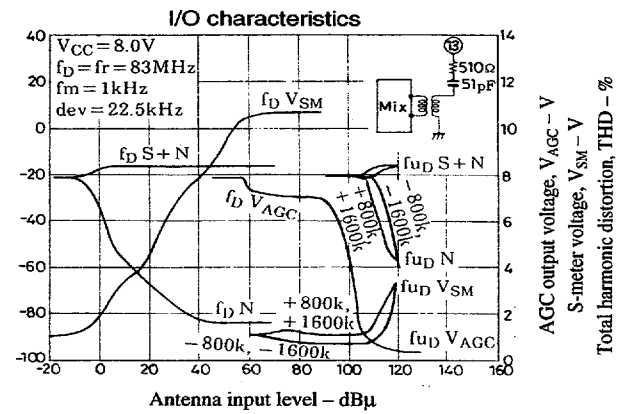
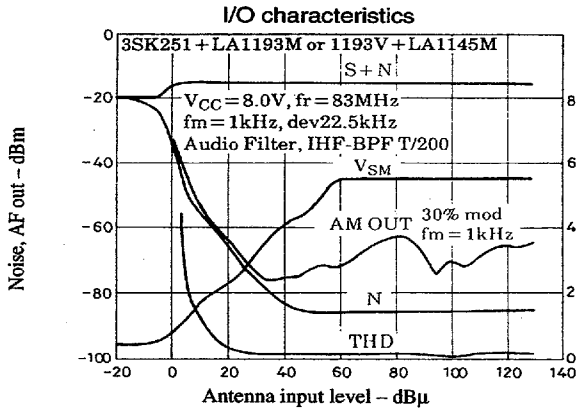
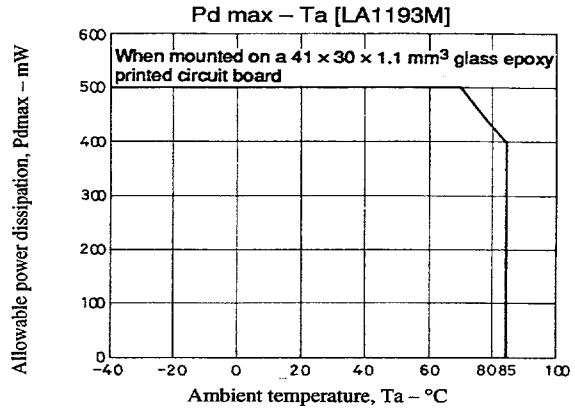
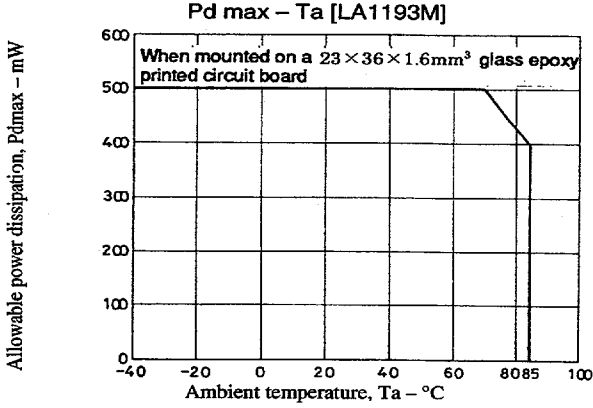

Three-signal interference characteristics

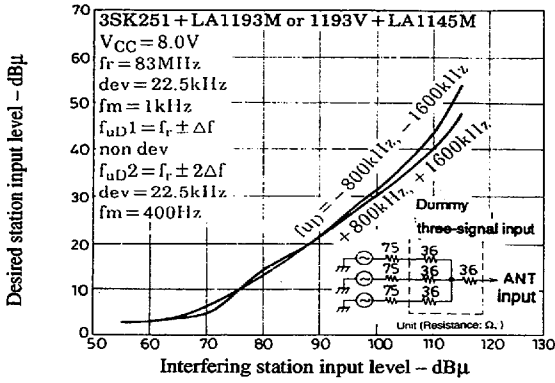

Three-signal interference characteristics

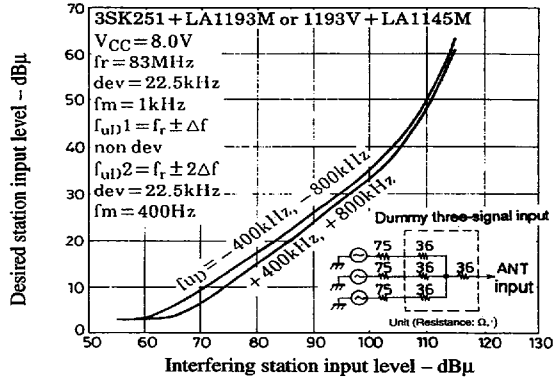

Two-signal interference characteristics

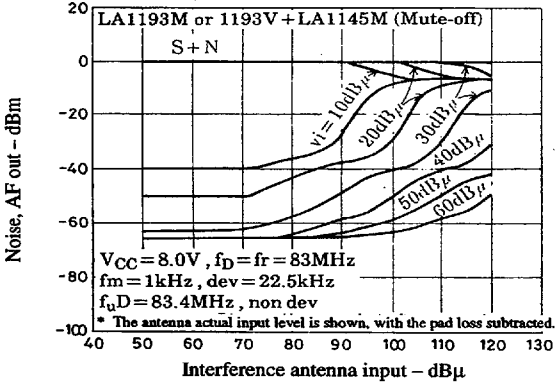

$V_{O\ AGC}$, antenna dump, FET source - $V_{IN\ ANT}$

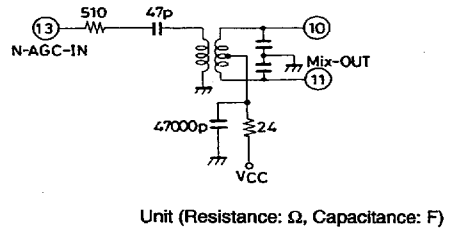
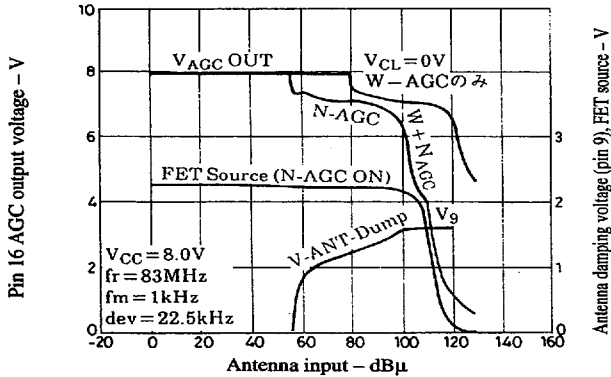

$V_{O\ AGC}$, I_{ANT-D} - $V_{IN\ MIX}$

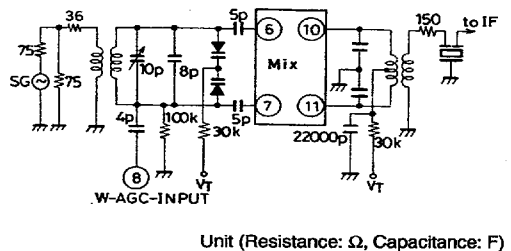
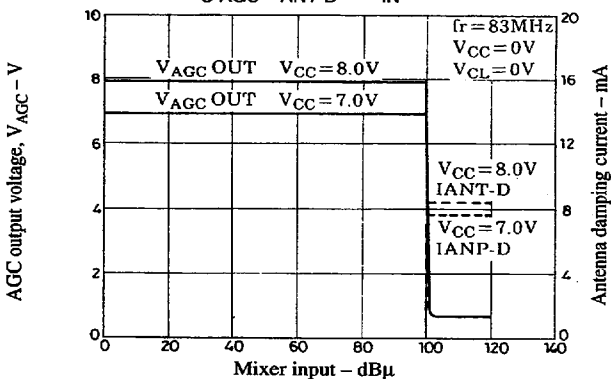

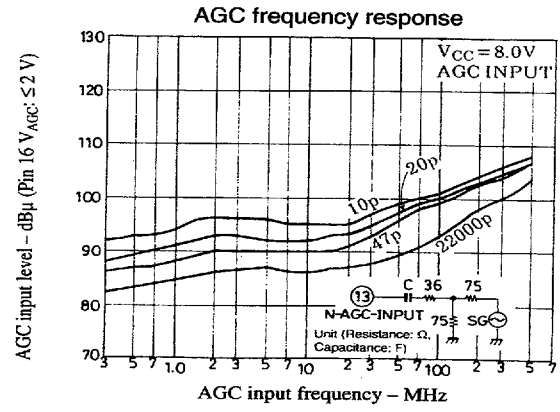
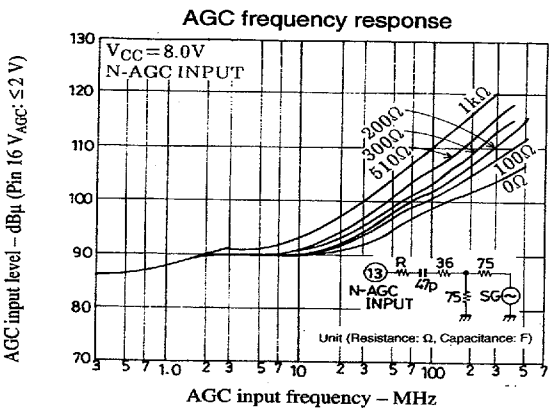
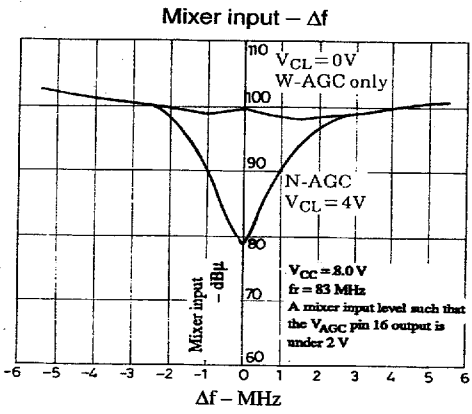
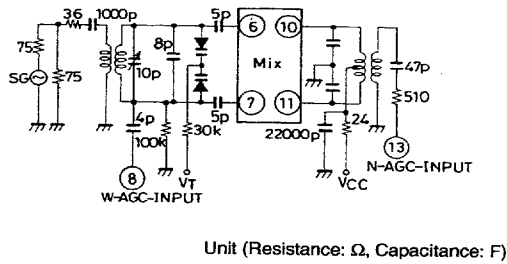
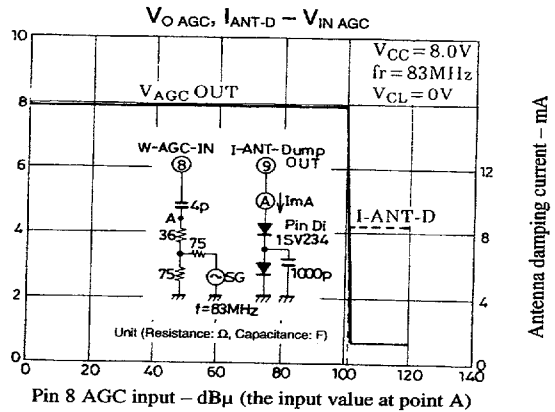
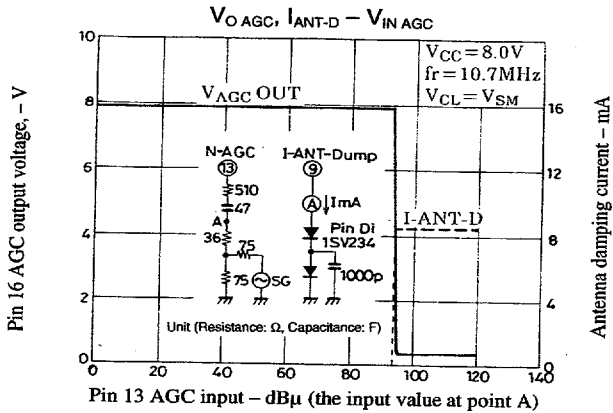
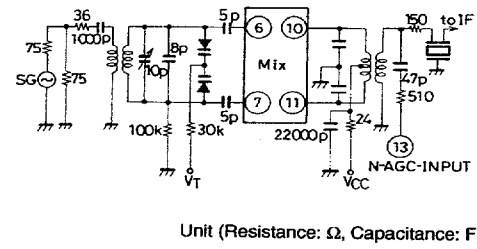
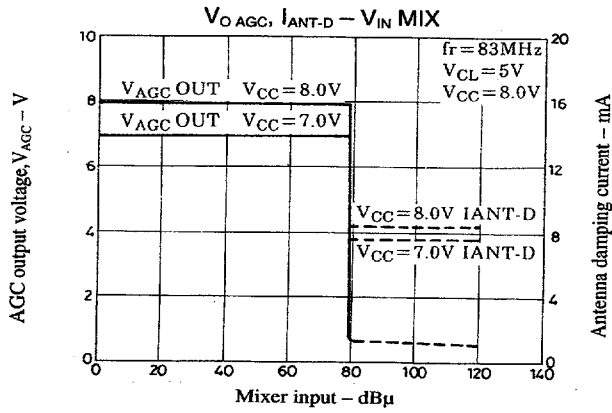

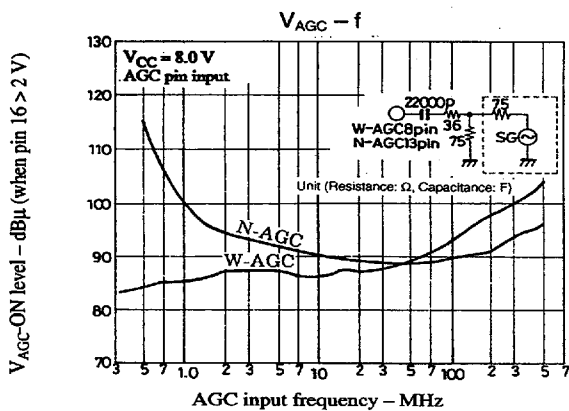
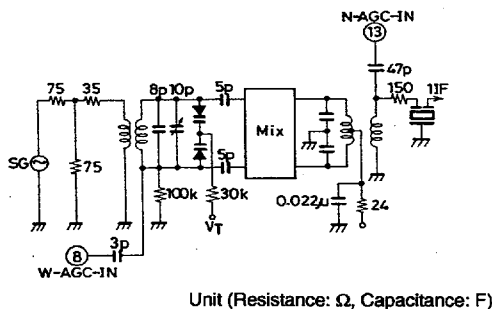
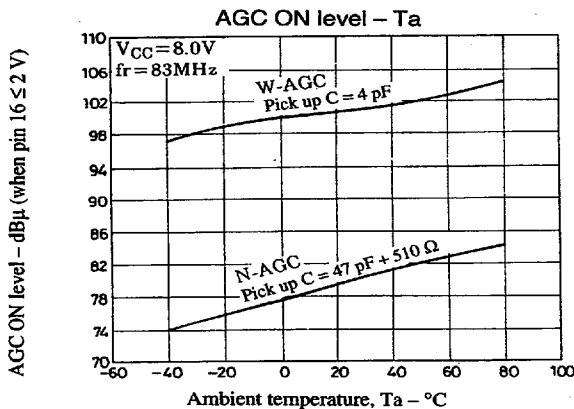
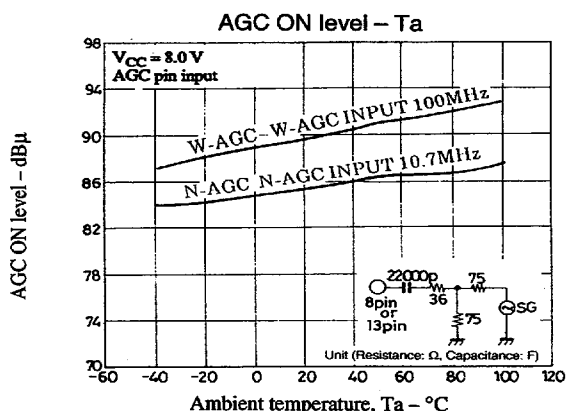
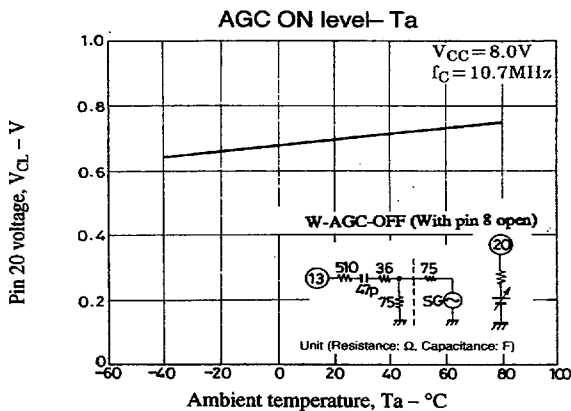
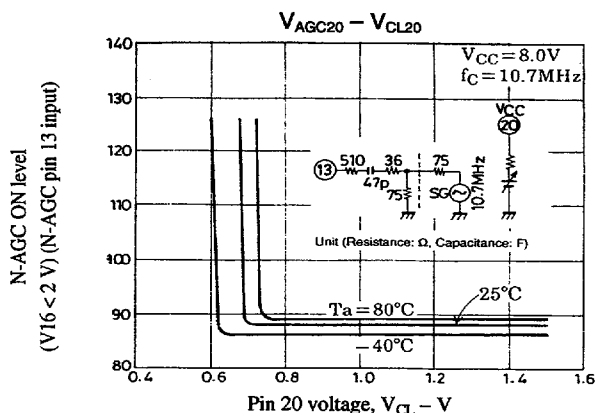
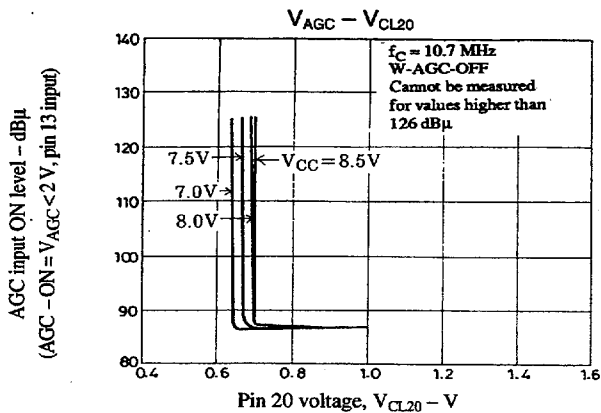

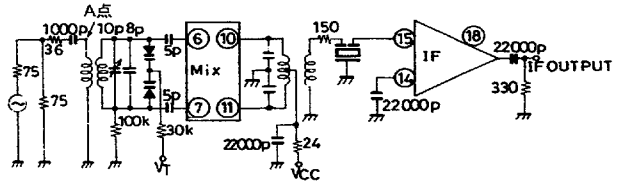
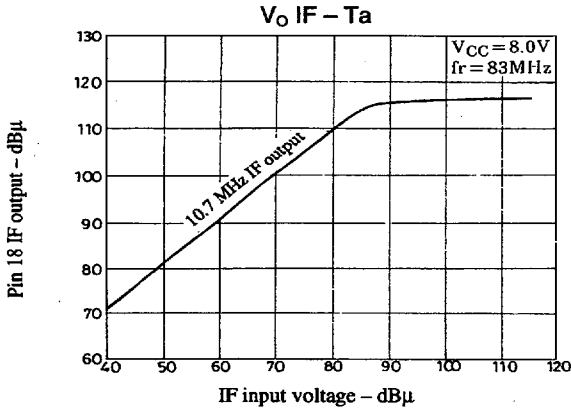

Unit (Resistance: Ω , Capacitance: F)

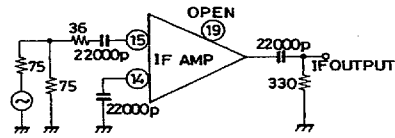
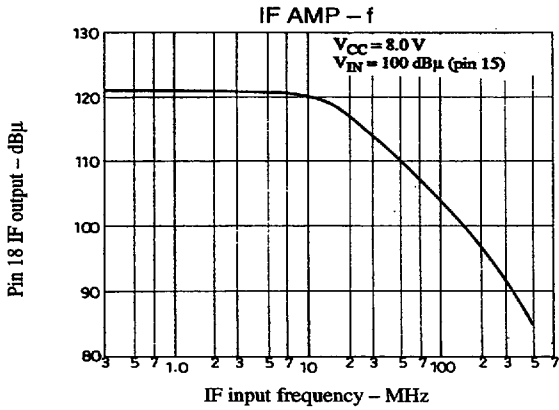

Unit (Resistance: Ω , Capacitance: F)

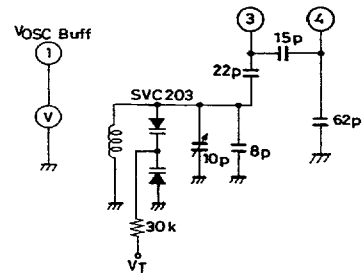
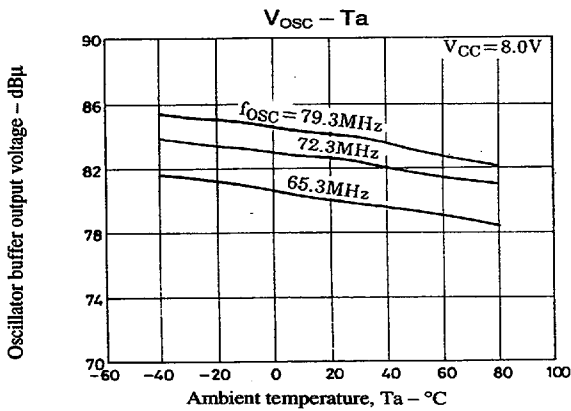

Unit (Resistance: Ω , Capacitance: F)

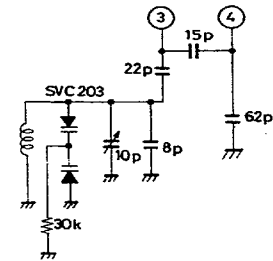
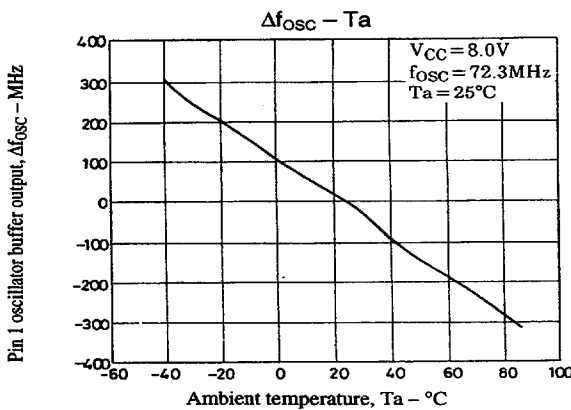

Unit (Resistance: Ω , Capacitance: F)

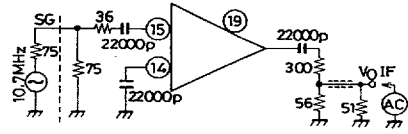
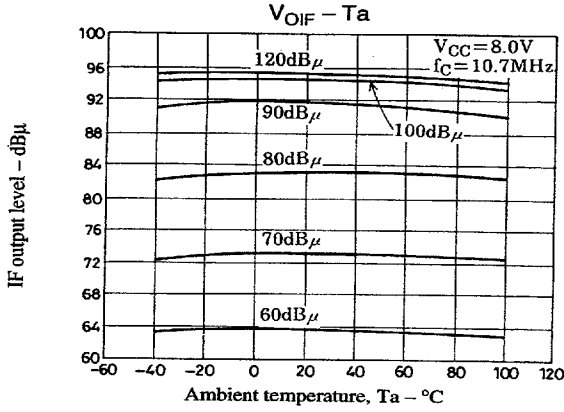

Unit (Resistance: Ω , Capacitance: F)

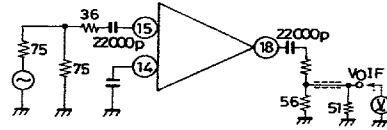
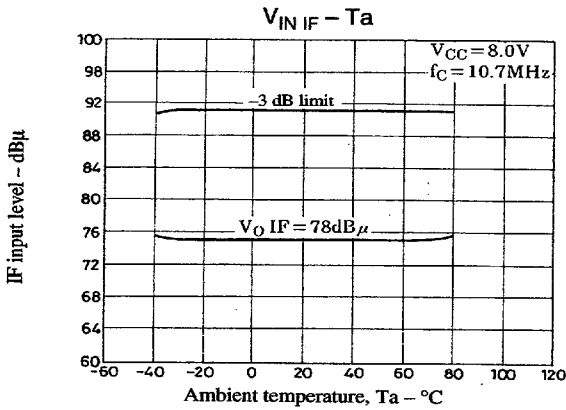

Unit (Resistance: Ω , Capacitance: F)

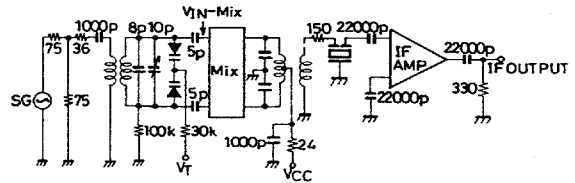
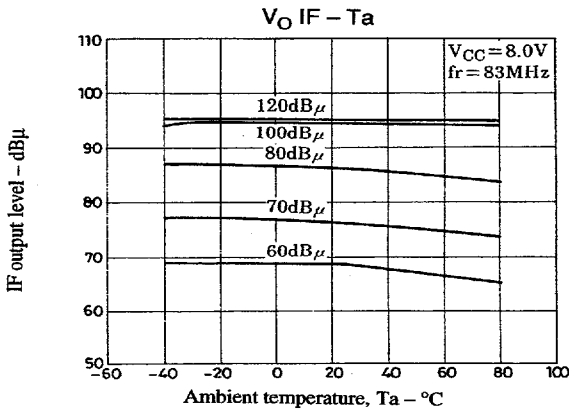

Unit (Resistance: Ω , Capacitance: F)

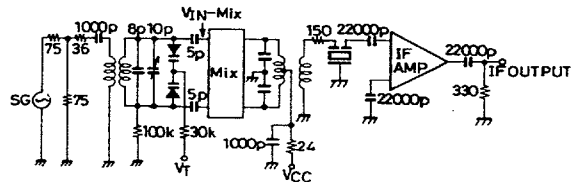
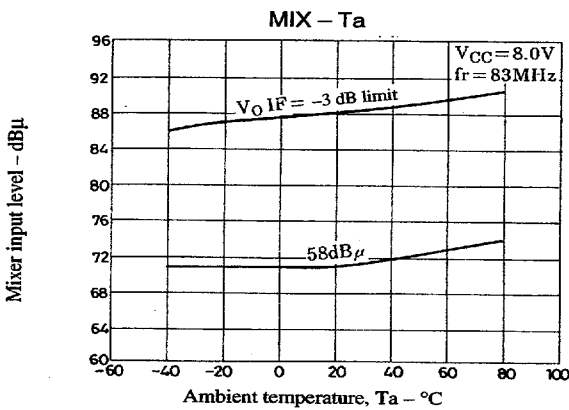

Unit (Resistance: Ω , Capacitance: F)

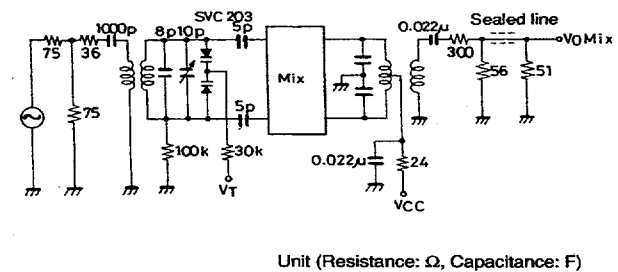
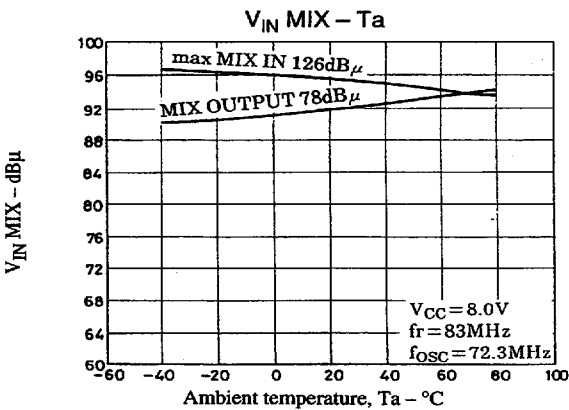
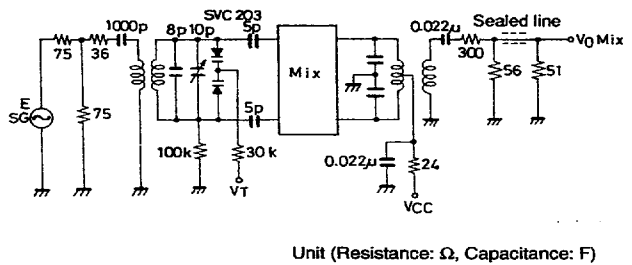
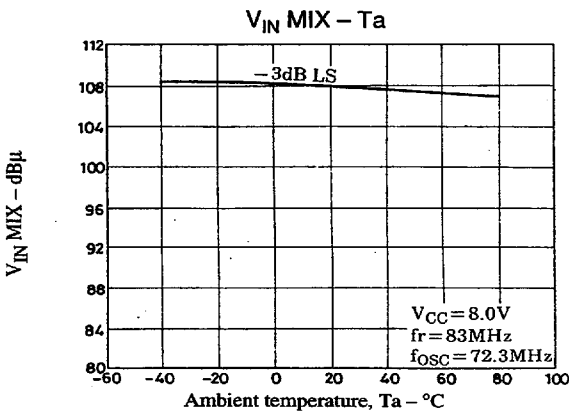
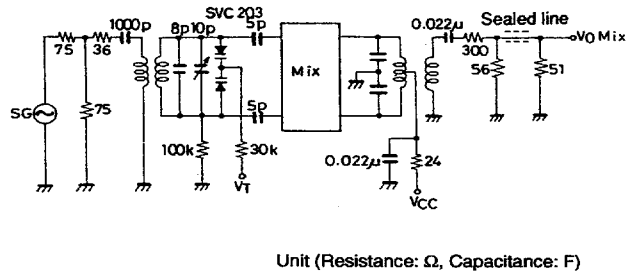
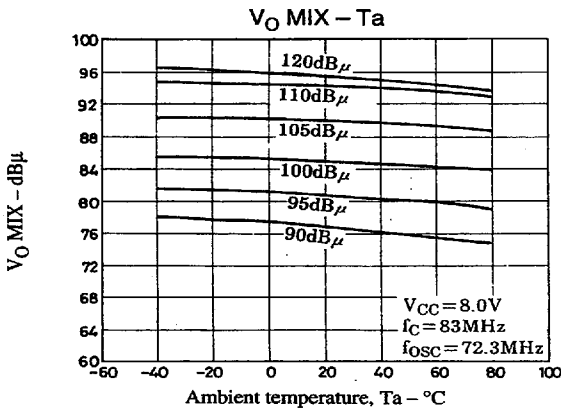
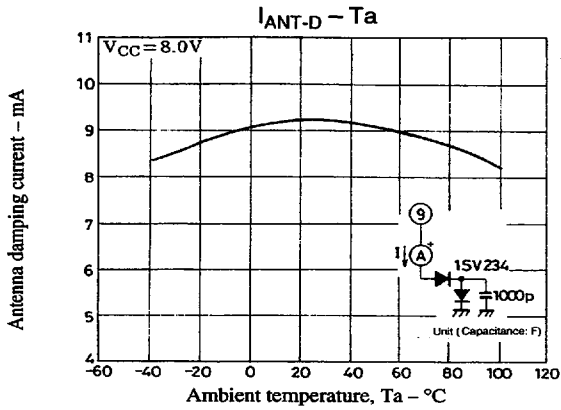

LA1193M, 1193V

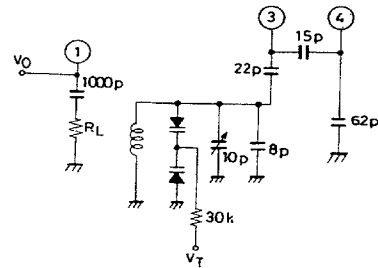
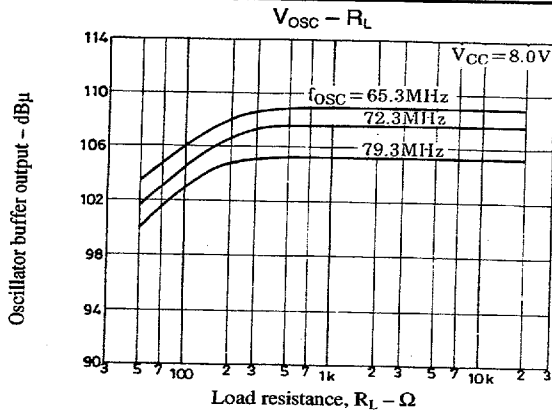

Unit (Resistance: Ω, Capacitance: F)

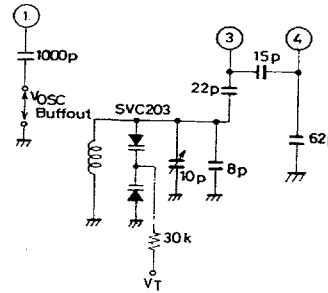
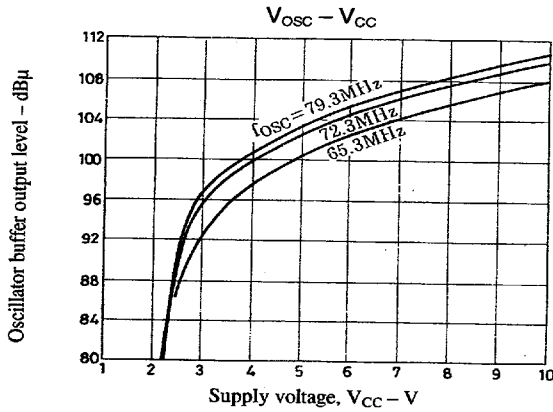

Unit (Resistance: Ω, Capacitance: F)

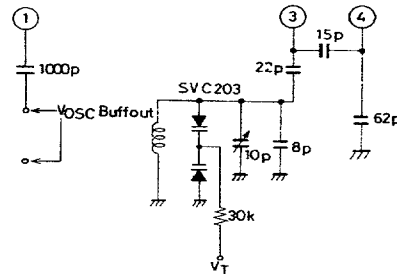
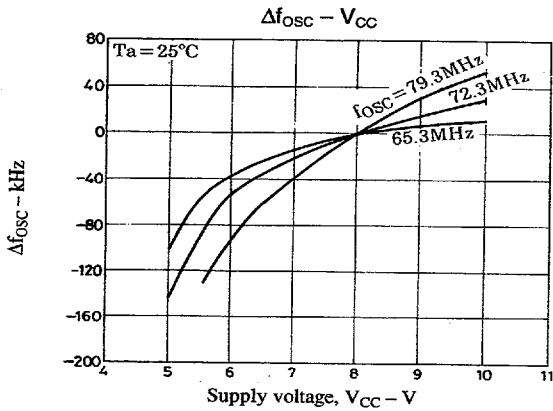

Unit (Resistance: Ω, Capacitance: F)

- No products described or contained herein are intended for use in surgical implants, life-support systems, aerospace equipment, nuclear power control systems, vehicles, disaster/crime-prevention equipment and the like, the failure of which may directly or indirectly cause injury, death or property loss.
- Anyone purchasing any products described or contained herein for an above-mentioned use shall:
 - ① Accept full responsibility and indemnify and defend SANYO ELECTRIC CO., LTD., its affiliates, subsidiaries and distributors and all their officers and employees, jointly and severally, against any and all claims and litigation and all damages, cost and expenses associated with such use;
 - ② Not impose any responsibility for any fault or negligence which may be cited in any such claim or litigation on SANYO ELECTRIC CO., LTD., its affiliates, subsidiaries and distributors or any of their officers and employees jointly or severally.
- Information (including circuit diagrams and circuit parameters) herein is for example only; it is not guaranteed for volume production. SANYO believes information herein is accurate and reliable, but no guarantees are made or implied regarding its use or any infringements of intellectual property rights or other rights of third parties.

This catalog provides information as of March, 1997. Specifications and information herein are subject to change without notice.