

SIPMOS® Power Transistor

- N channel
- Enhancement mode
- FREDFET

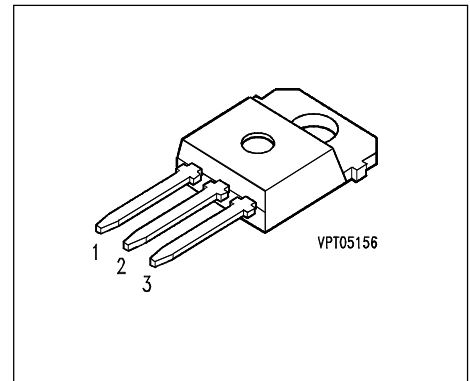

Pin 1	Pin 2	Pin 3
G	D	S

Type	V_{DS}	I_D	$R_{DS(on)}$	Package	Ordering Code
BUZ 384	500 V	10.5 A	0.6 Ω	TO-218 AA	C67078-A3209-A2

Maximum Ratings

Parameter	Symbol	Values	Unit
Drain source voltage	V_{DS}	500	V
Drain-gate voltage $R_{GS} = 20 \text{ k}\Omega$	V_{DGR}	500	
Continuous drain current $T_C = 25 \text{ }^\circ\text{C}$	I_D	10.5	A
Pulsed drain current $T_C = 25 \text{ }^\circ\text{C}$	I_{Dpuls}	42	
Gate source voltage	V_{GS}	± 20	V
Power dissipation $T_C = 25 \text{ }^\circ\text{C}$	P_{tot}	125	W
Operating temperature	T_j	-55 ... + 150	$^\circ\text{C}$
Storage temperature	T_{stg}	-55 ... + 150	
Thermal resistance, chip case	R_{thJC}	≤ 1	K/W
Thermal resistance, chip to ambient	R_{thJA}	75	
DIN humidity category, DIN 40 040		E	
IEC climatic category, DIN IEC 68-1		55 / 150 / 56	

Electrical Characteristics, at $T_j = 25^\circ\text{C}$, unless otherwise specified

Parameter	Symbol	Values			Unit
		min.	typ.	max.	
Static Characteristics					
Drain- source breakdown voltage $V_{GS} = 0\text{ V}, I_D = 0.25\text{ mA}, T_j = 25\text{ }^\circ\text{C}$	$V_{(BR)DSS}$	500	-	-	V
Gate threshold voltage $V_{GS}=V_{DS}, I_D = 1\text{ mA}$	$V_{GS(th)}$	2.1	3.5	4	
Zero gate voltage drain current $V_{DS} = 500\text{ V}, V_{GS} = 0\text{ V}, T_j = 25\text{ }^\circ\text{C}$ $V_{DS} = 500\text{ V}, V_{GS} = 0\text{ V}, T_j = 125\text{ }^\circ\text{C}$	I_{DSS}	-	20 100	250 1000	μA
Gate-source leakage current $V_{GS} = 20\text{ V}, V_{DS} = 0\text{ V}$	I_{GSS}	-	10	100	nA
Drain-Source on-resistance $V_{GS} = 10\text{ V}, I_D = 6.5\text{ A}$	$R_{DS(on)}$	-	0.55	0.6	Ω

Electrical Characteristics, at $T_j = 25^\circ\text{C}$, unless otherwise specified

Parameter	Symbol	Values			Unit
		min.	typ.	max.	
Dynamic Characteristics					
Transconductance $V_{DS} \geq 2 \cdot I_D \cdot R_{DS(on)max}, I_D = 6.5 \text{ A}$	g_{fs}	2.7	6.7	-	S
Input capacitance $V_{GS} = 0 \text{ V}, V_{DS} = 25 \text{ V}, f = 1 \text{ MHz}$	C_{iss}	-	3800	4900	pF
Output capacitance $V_{GS} = 0 \text{ V}, V_{DS} = 25 \text{ V}, f = 1 \text{ MHz}$	C_{oss}	-	250	400	
Reverse transfer capacitance $V_{GS} = 0 \text{ V}, V_{DS} = 25 \text{ V}, f = 1 \text{ MHz}$	C_{rss}	-	100	170	
Turn-on delay time $V_{DD} = 30 \text{ V}, V_{GS} = 10 \text{ V}, I_D = 2.8 \text{ A}$ $R_{GS} = 50 \Omega$	$t_{d(on)}$	-	50	75	ns
Rise time $V_{DD} = 30 \text{ V}, V_{GS} = 10 \text{ V}, I_D = 2.8 \text{ A}$ $R_{GS} = 50 \Omega$	t_r	-	80	120	
Turn-off delay time $V_{DD} = 30 \text{ V}, V_{GS} = 10 \text{ V}, I_D = 2.8 \text{ A}$ $R_{GS} = 50 \Omega$	$t_{d(off)}$	-	330	430	
Fall time $V_{DD} = 30 \text{ V}, V_{GS} = 10 \text{ V}, I_D = 2.8 \text{ A}$ $R_{GS} = 50 \Omega$	t_f	-	110	140	

Electrical Characteristics, at $T_j = 25^\circ\text{C}$, unless otherwise specified

Parameter	Symbol	Values			Unit
		min.	typ.	max.	
Reverse Diode					
Inverse diode continuous forward current $T_C = 25^\circ\text{C}$	I_S	-	-	10.5	A
Inverse diode direct current, pulsed $T_C = 25^\circ\text{C}$	I_{SM}	-	-	42	
Inverse diode forward voltage $V_{GS} = 0\text{ V}, I_F = 21\text{ A}$	V_{SD}	-	1.3	1.7	V
Reverse recovery time $V_R = 100\text{ V}, I_F = I_S, di_F/dt = 100\text{ A}/\mu\text{s}$	t_{rr}	-	180	250	ns
Reverse recovery charge $V_R = 100\text{ V}, I_F = I_S, di_F/dt = 100\text{ A}/\mu\text{s}$	Q_{rr}	-	0.65	1.2	μC

Power dissipation

$$P_{\text{tot}} = f(T_C)$$

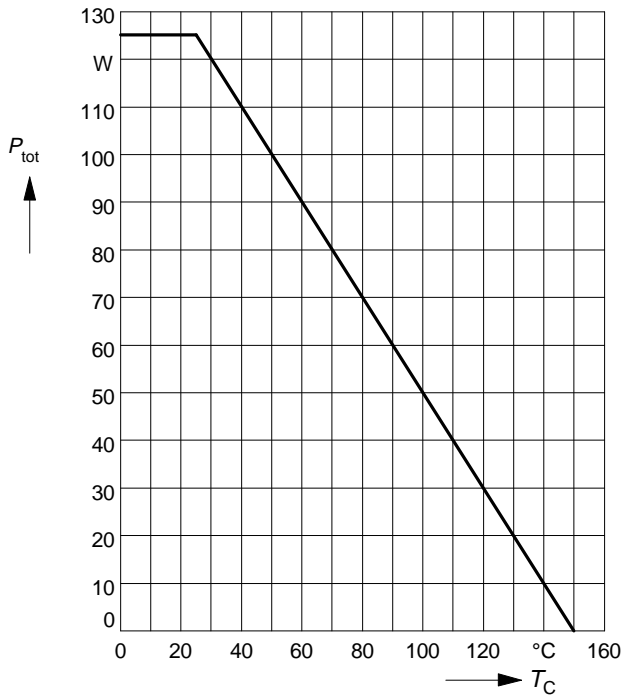

Drain current

$$I_D = f(T_C)$$

parameter: $V_{GS} \geq 10 \text{ V}$

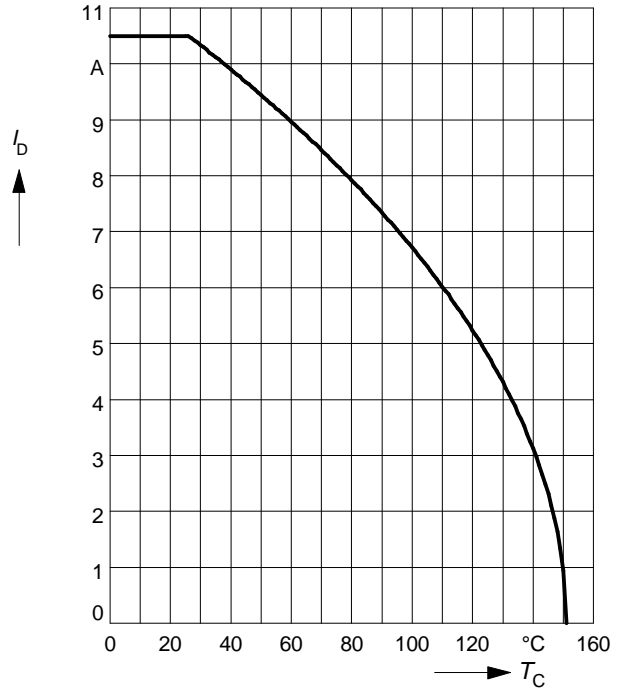

Safe operating area

$$I_D = f(V_{DS})$$

parameter: $D = 0.01$, $T_C = 25^\circ\text{C}$

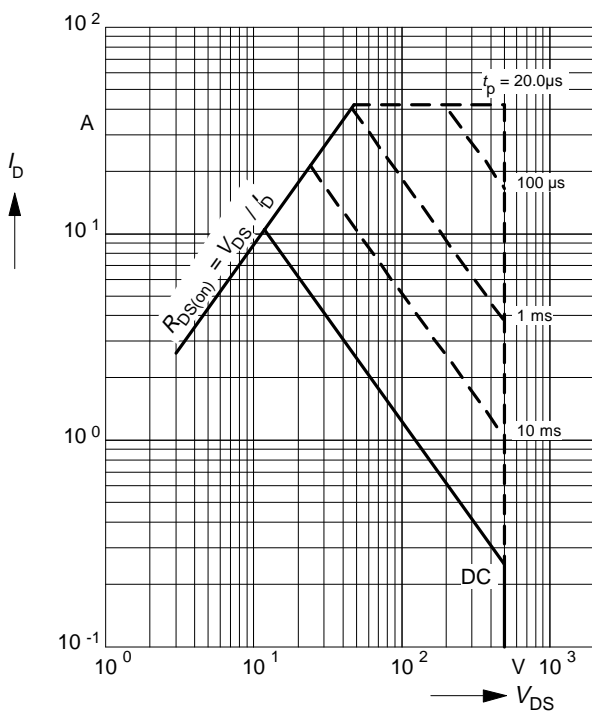

Transient thermal impedance

$$Z_{\text{thJC}} = f(t_p)$$

parameter: $D = t_p / T$

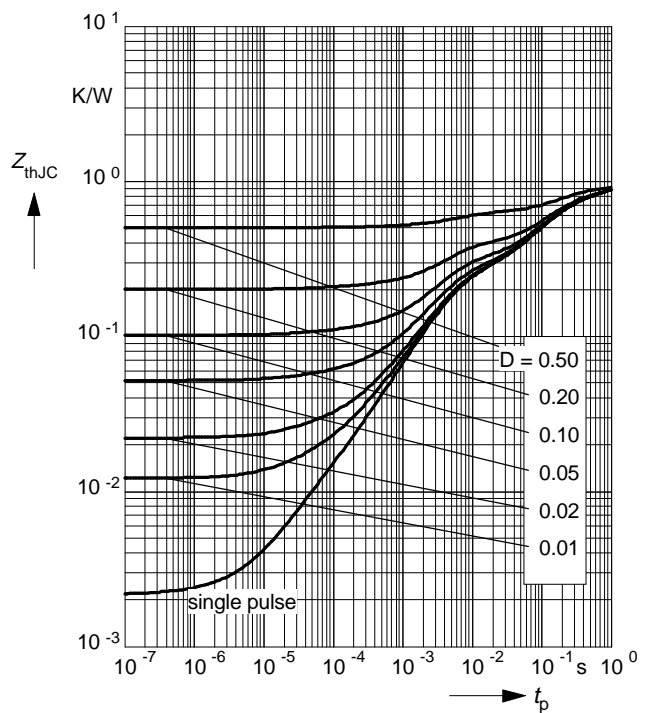

Typ. output characteristics

$$I_D = f(V_{DS})$$

parameter: $t_p = 80 \mu s$

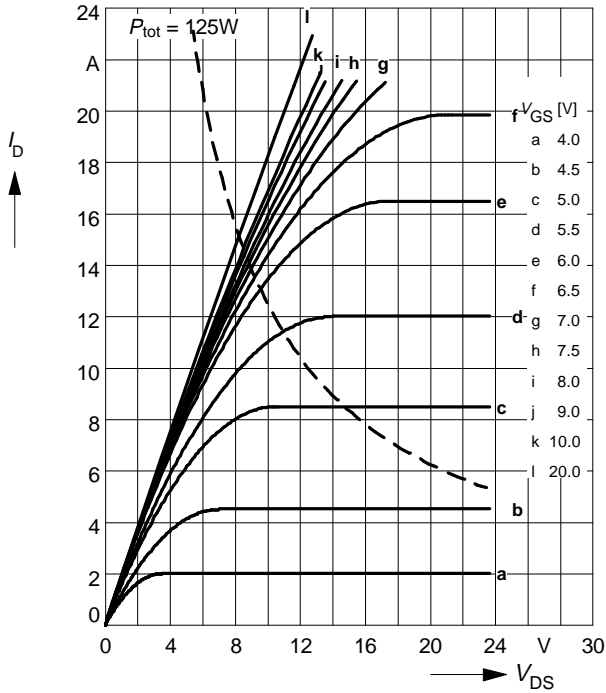

Typ. drain-source on-resistance

$$R_{DS(on)} = f(I_D)$$

parameter: V_{GS}

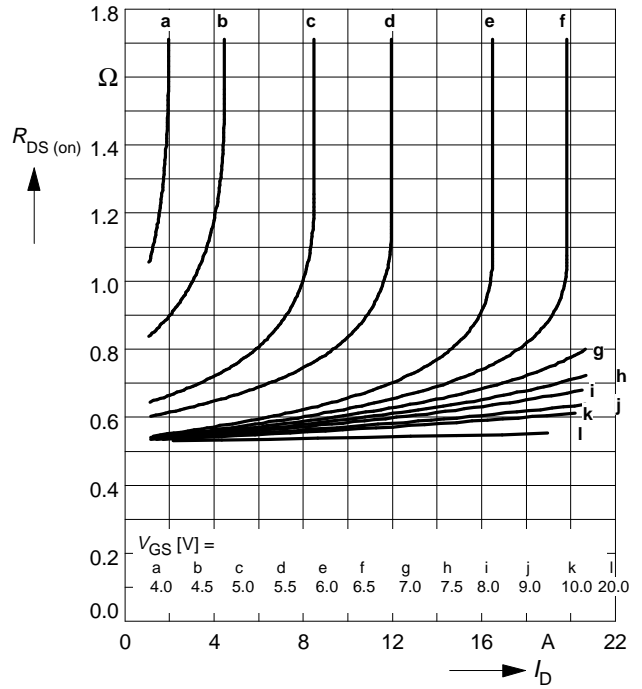

Typ. transfer characteristics $I_D = f(V_{GS})$

parameter: $t_p = 80 \mu s$

$$V_{DS} \geq 2 \times I_D \times R_{DS(on)max}$$

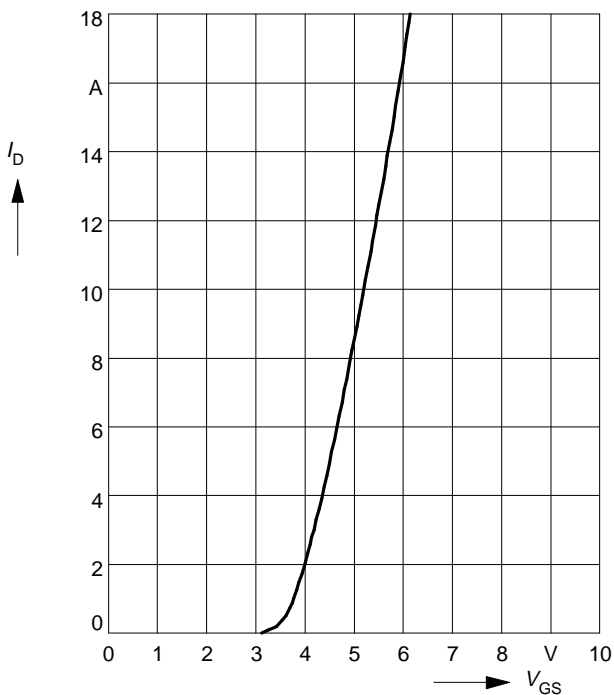

Typ. forward transconductance $g_{fs} = f(I_D)$

parameter: $t_p = 80 \mu s$,

$$V_{DS} \geq 2 \times I_D \times R_{DS(on)max}$$

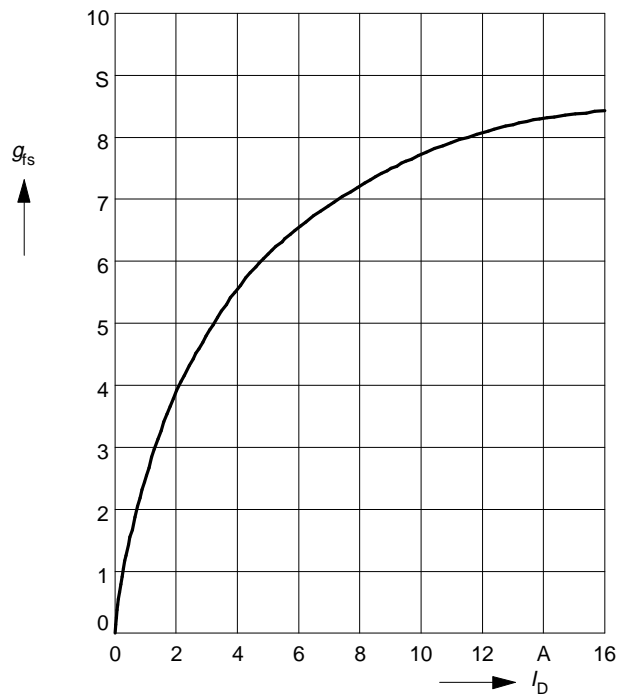

Drain-source on-resistance

$$R_{DS(on)} = f(T_j)$$

parameter: $I_D = 6.5 \text{ A}$, $V_{GS} = 10 \text{ V}$

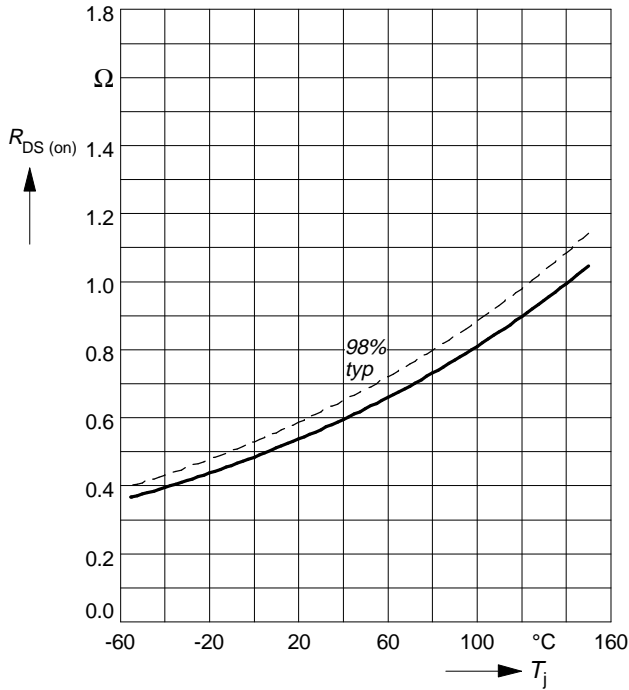

Gate threshold voltage

$$V_{GS(th)} = f(T_j)$$

parameter: $V_{GS} = V_{DS}$, $I_D = 1 \text{ mA}$

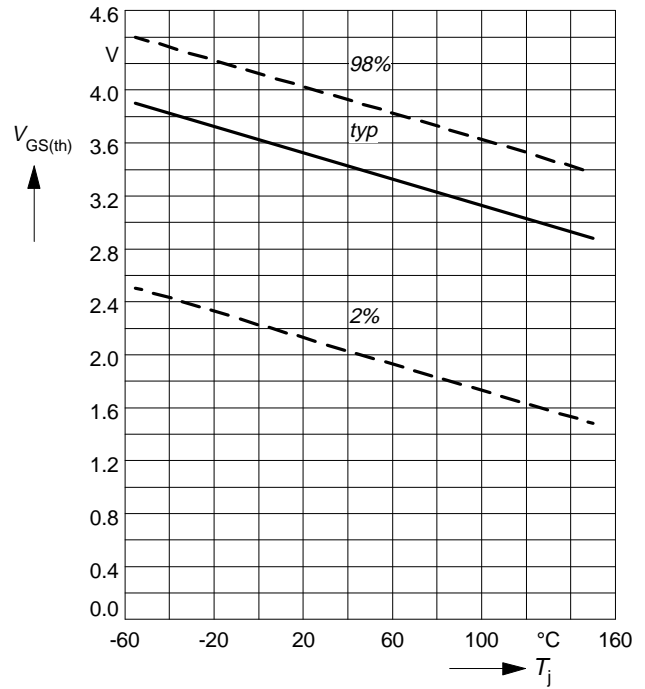

Typ. capacitances

$$C = f(V_{DS})$$

parameter: $V_{GS} = 0 \text{ V}$, $f = 1 \text{ MHz}$

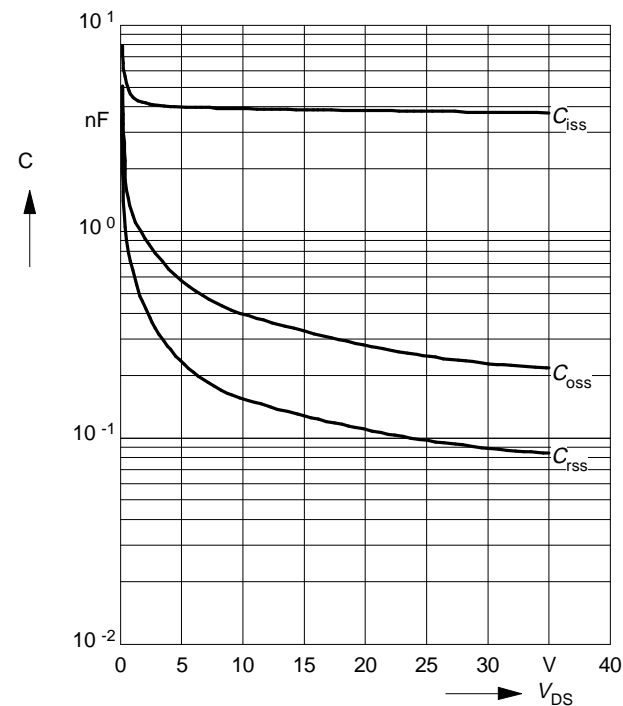

Forward characteristics of reverse diode

$$I_F = f(V_{SD})$$

parameter: T_j , $t_p = 80 \mu\text{s}$

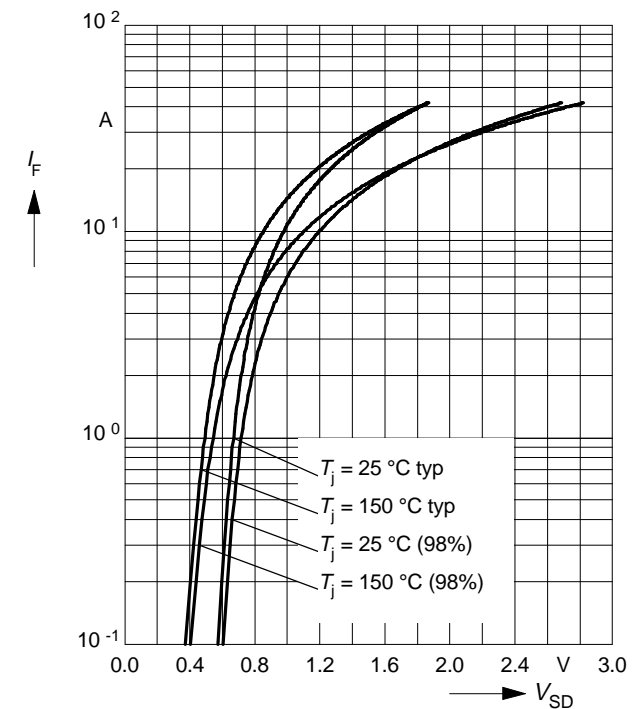

Drain-source breakdown voltage

$$V_{(BR)DSS} = f(T_j)$$

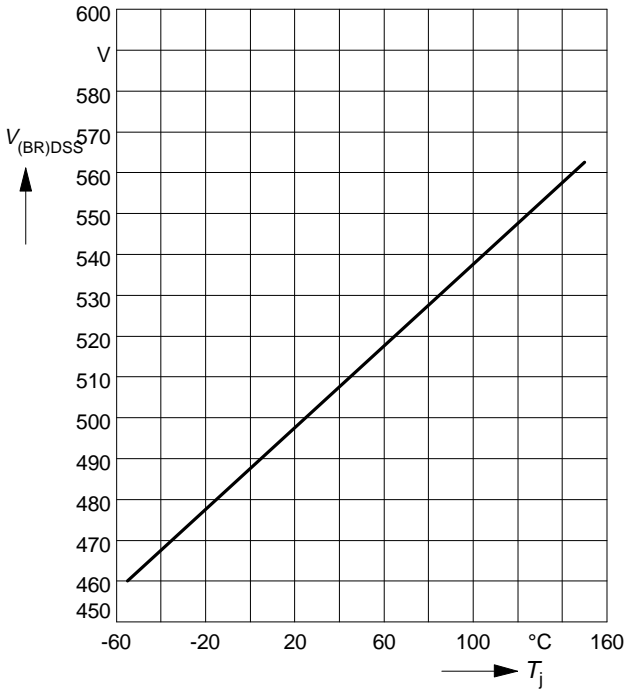

Typ. gate charge

$$V_{GS} = f(Q_{Gate})$$

parameter: $I_{D\ puls} = 14\ A$

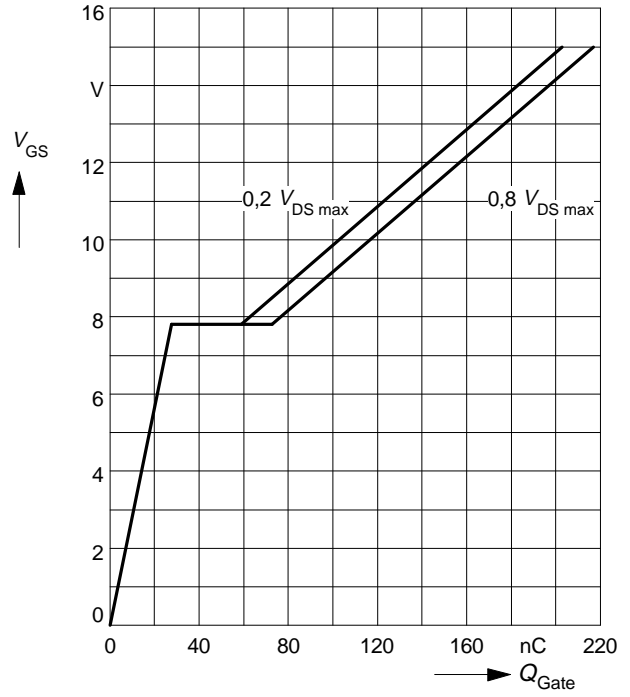

Package Outlines

TO-218 AA

Dimension in mm

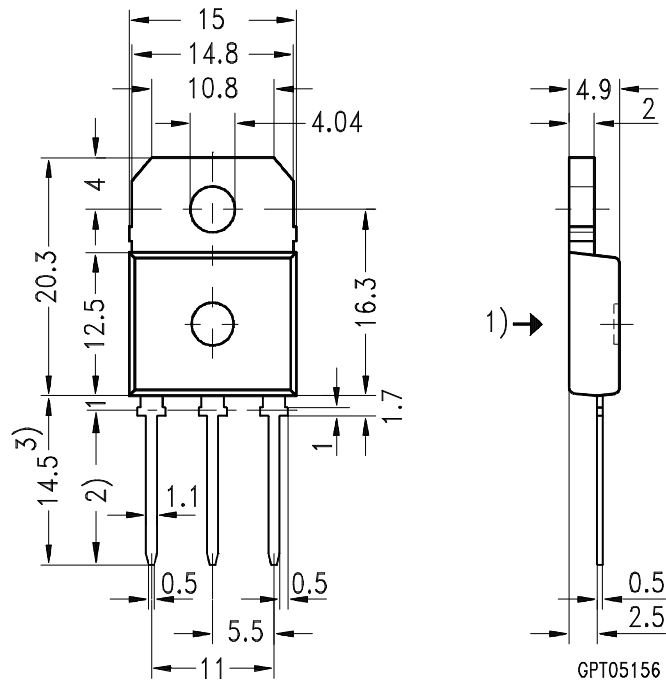

- 1) punch direction, burr max. 0.04
- 2) dip tinning
- 3) max. 15.5 by dip tinning press burr max. 0.05