

> **Features**

- High Current
- Low On-Resistance
- No Secondary Breakdown
- Low Driving Power
- Avalanche Rated

> **Applications**

- Motor Control
- General Purpose Power Amplifier
- DC-DC converters

> **Outline Drawing**

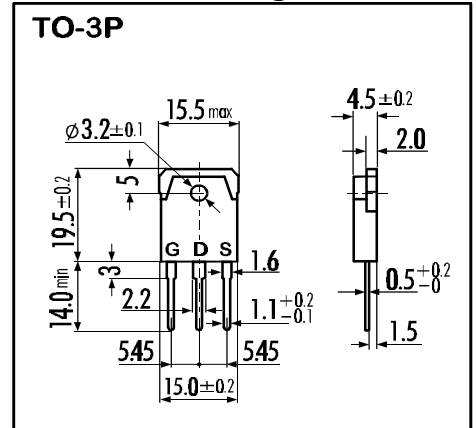

> **Maximum Ratings and Characteristics**

- Absolute Maximum Ratings (T<sub>C</sub>=25°C), unless otherwise specified

Item	Symbol	Rating	Unit
Drain-Source-Voltage	V <sub>DS</sub>	60	V
Continous Drain Current	I <sub>D</sub>	80	A
Pulsed Drain Current	I <sub>D(puls)</sub>	320	A
Gate-Source-Voltage	V <sub>GS</sub>	±20	V
Maximum Avalanche Energy	E <sub>AV</sub>	599	mJ*
Max. Power Dissipation	P <sub>D</sub>	125	W
Operating and Storage Temperature Range	T <sub>ch</sub>	150	°C
	T <sub>stg</sub>	-55 ~ +150	°C

\* L=0,125mH, V<sub>CC</sub>=24V

> **Equivalent Circuit**

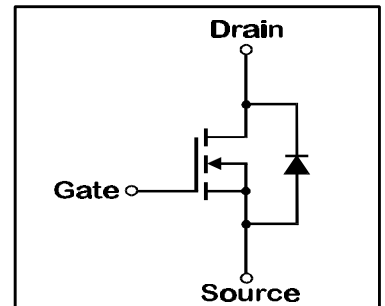

- Electrical Characteristics (T<sub>C</sub>=25°C), unless otherwise specified

Item	Symbol	Test conditions	Min.	Typ.	Max.	Unit
Drain-Source Breakdown-Voltage	V <sub>(BR)DSS</sub>	I <sub>D</sub> =1mA V <sub>GS</sub> =0V	60			V
Gate Threshold Voltage	V <sub>GS(th)</sub>	I <sub>D</sub> =1mA V <sub>DS</sub> =V <sub>GS</sub>	1,0	1,5	2,0	V
Zero Gate Voltage Drain Current	I <sub>DSS</sub>	V <sub>DS</sub> =60V T <sub>ch</sub> =25°C		10	500	μA
		V <sub>GS</sub> =0V T <sub>ch</sub> =125°C		0,2	1,0	mA
Gate Source Leakage Current	I <sub>GSS</sub>	V <sub>GS</sub> =±20V V <sub>DS</sub> =0V		10	100	nA
Drain Source On-State Resistance	R <sub>DS(on)</sub>	I <sub>D</sub> =40A V <sub>GS</sub> =4V		0,012	0,017	Ω
		I <sub>D</sub> =40A V <sub>GS</sub> =10V		0,0075	0,01	Ω
Forward Transconductance	g <sub>fs</sub>	I <sub>D</sub> =40A V <sub>DS</sub> =25V	25	55		S
Input Capacitance	C <sub>iss</sub>	V <sub>DS</sub> =25V		3500	5250	pF
Output Capacitance	C <sub>oss</sub>	V <sub>GS</sub> =0V		1250	1870	pF
Reverse Transfer Capacitance	C <sub>rss</sub>	f=1MHz		360	540	pF
Turn-On-Time t <sub>on</sub> (t <sub>on</sub> =t <sub>d(on)</sub> +t <sub>r</sub> )	t <sub>d(on)</sub>	V <sub>CC</sub> =30V		15	23	ns
		I <sub>D</sub> =75A		75	120	ns
Turn-Off-Time t <sub>off</sub> (t <sub>off</sub> =t <sub>d(off)</sub> +t <sub>f</sub> )	t <sub>d(off)</sub>	V <sub>GS</sub> =10V		190	285	ns
		R <sub>GS</sub> =10 Ω		110	165	ns
Avalanche Capability	I <sub>AV</sub>	L = 100μH T <sub>ch</sub> =25°C	80			A
Diode Forward On-Voltage	V <sub>SD</sub>	I <sub>F</sub> =160A V <sub>GS</sub> =0V T <sub>ch</sub> =25°C		1,15	1,65	V
Reverse Recovery Time	t <sub>rr</sub>	I <sub>F</sub> =80A V <sub>GS</sub> =0V		75	120	ns
Reverse Recovery Charge	Q <sub>rr</sub>	-dI <sub>F</sub> /dt=100A/μs T <sub>ch</sub> =25°C		0,17		μC

- Thermal Characteristics

Item	Symbol	Test conditions	Min.	Typ.	Max.	Unit
Thermal Resistance	R <sub>th(ch-a)</sub>	channel to air			35	°C/W
	R <sub>th(ch-c)</sub>	channel to case			1,0	°C/W

# N-channel MOS-FET

60V | 0,01Ω | 80A | 125W

# 2SK2690-01

## FAP-III B Series



### > Characteristics

Typical Output Characteristics

$I_D = f(V_{DS})$ ; 80μs pulse test;  $T_C = 25^\circ\text{C}$

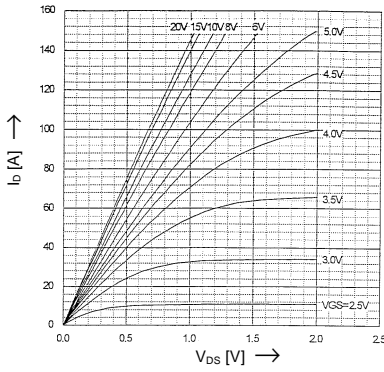

Drain-Source On-State Resistance vs.  $T_{ch}$

$R_{DS(on)} = f(T_{ch})$ ;  $I_D = 40\text{A}$ ;  $V_{GS} = 10\text{V}$

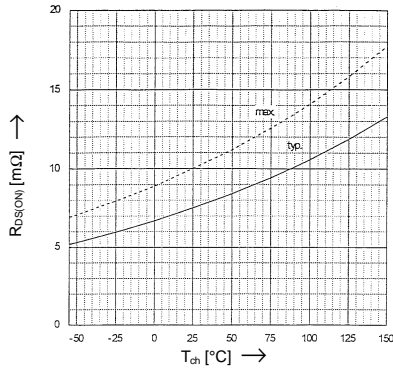

Typical Transfer Characteristics

$I_D = f(V_{GS})$ ; 80μs pulse test;  $V_{DS} = 25\text{V}$ ;  $T_{ch} = 25^\circ\text{C}$

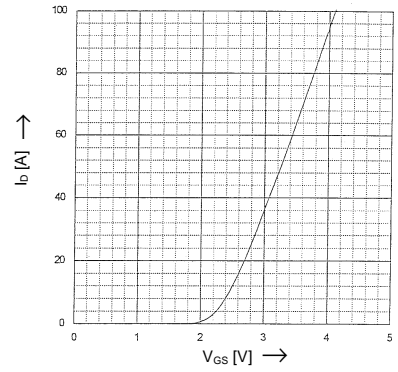

Typical Drain-Source On-State-Resistance vs.  $I_D$

$R_{DS(on)} = f(I_D)$ ; 80μs pulse test;  $T_C = 25^\circ\text{C}$

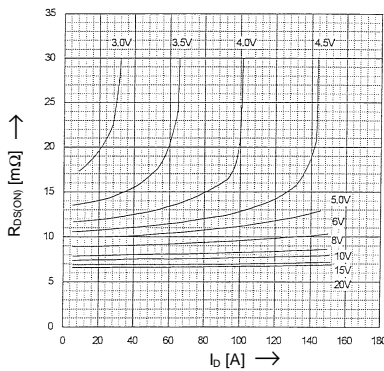

Typical Forward Transconductance vs.  $I_D$

$g_{fs} = f(I_D)$ ; 80μs pulse test;  $V_{DS} = 25\text{V}$ ;  $T_{ch} = 25^\circ\text{C}$

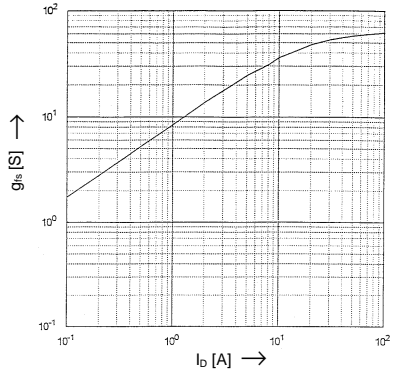

Gate Threshold Voltage vs.  $T_{ch}$

$V_{GS(th)} = f(T_{ch})$ ;  $I_D = 1\text{mA}$ ;  $V_{DS} = V_{GS}$

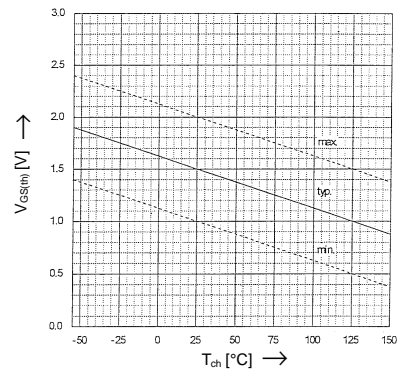

Typical Capacitances vs.  $V_{DS}$

$C = f(V_{DS})$ ;  $V_{GS} = 0\text{V}$ ;  $f = 1\text{MHz}$

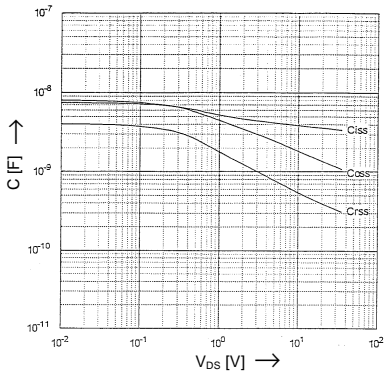

Typical Gate Charge Characteristic

$V_{GS} = f(Q_g)$ ;  $I_D = 80\text{A}$ ;  $T_C = 25^\circ\text{C}$

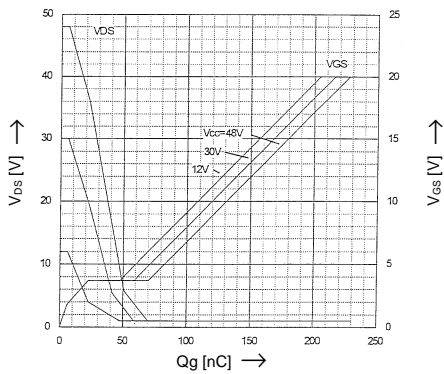

Forward Characteristics of Reverse Diode

$I_F = f(V_{SD})$ ; 80μs pulse test;  $T_{ch} = 25^\circ\text{C}$

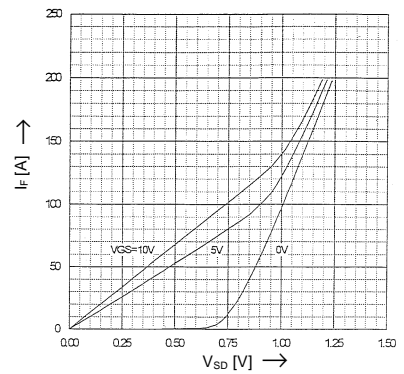

Maximum Avalanche Energy vs. starting  $T_{ch}$

$E_{AV} = f(\text{starting } T_{ch})$ ;  $V_{CC} = 24\text{V}$ ;  $I_{AV} \leq 80\text{A}$

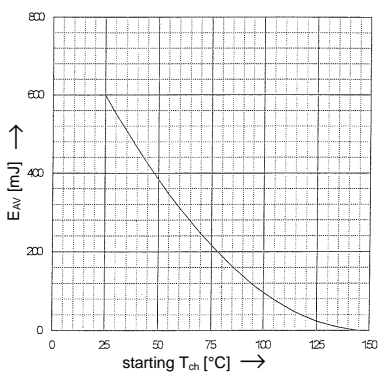

Safe Operation Area

$I_D = f(V_{DS})$ ;  $D = 0,01$ ;  $T_C = 25^\circ\text{C}$

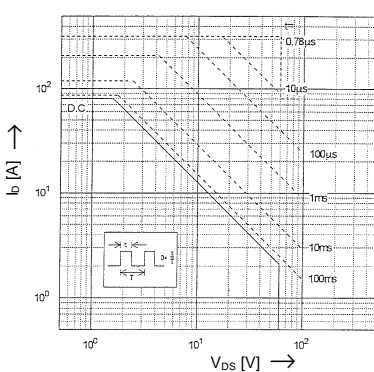

Transient Thermal impedance

$Z_{th(ch-e)} = f(t)$  parameter:  $D = t/T$

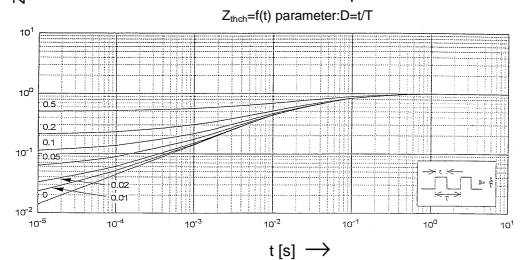

N-channel MOS-FET			
60V	0,01Ω	80A	125W

# 2SK2690-01

## FAP-III B Series



### > Characteristics

Power Dissipation  
 $P_D = f(T_C)$

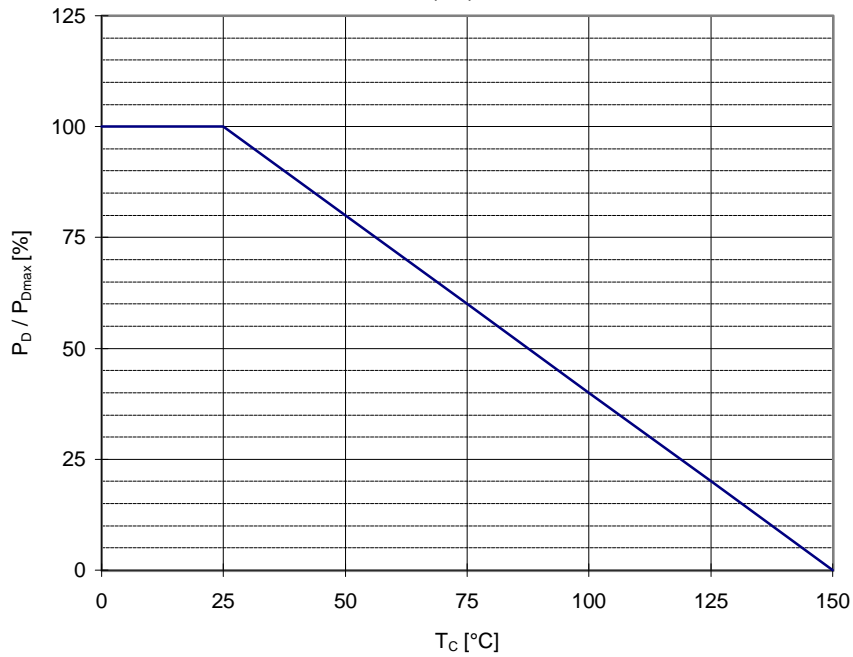

Maximum Avalanche Current vs. starting  $T_{ch}$   
 $I_{AV} = f(\text{starting } T_{ch})$

