

## GaAs MMIC HERMETIC SMT VOLTAGE-VARIABLE ATTENUATOR, DC - 8 GHz

### Typical Applications

The HMC346G8 is ideal for:

- Basestation Infrastructure
- Fiber Optics & Broadband Telecom
- Microwave Radio & VSAT
- Military Radios, Radar, & ECM
- Test Instrumentation

### Features

- Wide Bandwidth: DC - 8 GHz
- Low Phase Shift vs. Attenuation
- 30 dB Attenuation Range
- 8 Lead Hermetic SMT Package

### Functional Diagram

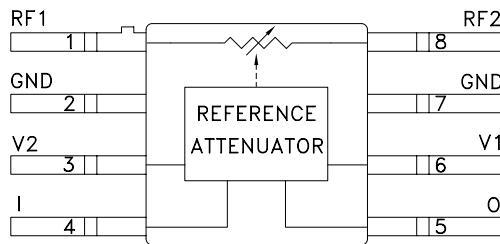

### General Description

The HMC346G8 is an absorptive Voltage Variable Attenuator (VVA) in an 8 lead glass/metal (hermetic) surface-mount package operating from DC - 8 GHz. It features an on-chip reference attenuator for use with an external op-amp to provide simple single voltage attenuation control, 0 to -3V. The device is ideal in designs where an analog DC control signal must control RF signal levels over a 30 dB amplitude range. Applications include AGC circuits and temperature compensation of multiple gain stages in microwave radios and test instrumentation.

### Electrical Specifications, $T_A = +25^\circ C$ , 50 ohm system

Parameter	Min	Typical	Max	Units	
Insertion Loss		DC - 6 GHz	2.0	3.0	dB
		DC - 8 GHz	2.0	3.5	dB
Attenuation Range		30		dB	
Return Loss	7	10		dB	
Switching Characteristics		tRISE, tFALL (10/90% RF)	2		ns
		tON, tOFF (50% CTL to 10/90% RF)	8		ns
Input Power for 0.25 dB Compression (0.5 - 8 GHz)	Min. Atten. Atten. >2 dB		+8		dBm
			-2		dBm
Input Third Order Intercept (0.5 - 8 GHz) (Two-tone Input Power = -8 dBm Each Tone)	Min. Atten. Atten. >2 dB		+25		dBm
			+10		dBm

For price, delivery, and to place orders, please contact Hittite Microwave Corporation:  
 12 Elizabeth Drive, Chelmsford, MA 01824 Phone: 978-250-3343 Fax: 978-250-3373  
 Order Online at [www.hittite.com](http://www.hittite.com)

**GaAs MMIC HERMETIC SMT VOLTAGE-VARIABLE ATTENUATOR, DC - 8 GHz**

**Insertion Loss vs. Temperature**

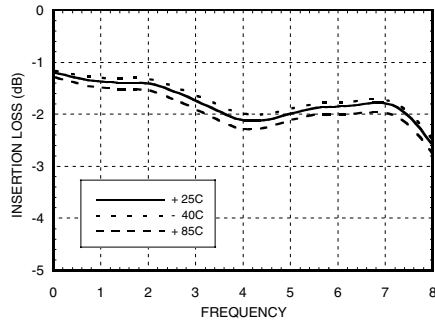

**Relative Attenuation, Control Voltage Optimized for 4 GHz Operation**

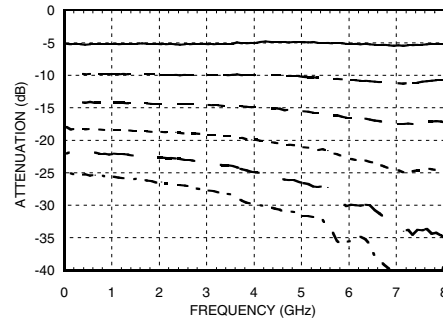

**Return Loss vs. Attenuation**

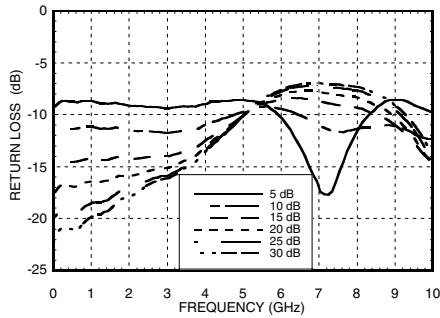

**Relative Attenuation, Control Voltage Optimized for 8 GHz Operation**

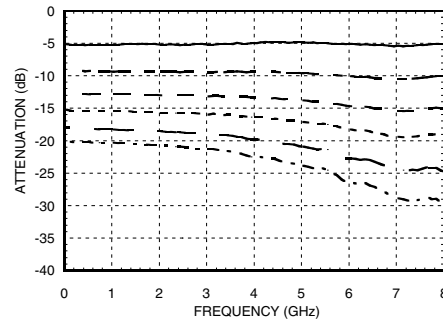

**Relative Attenuation vs. Control Voltage @ 4 GHz**

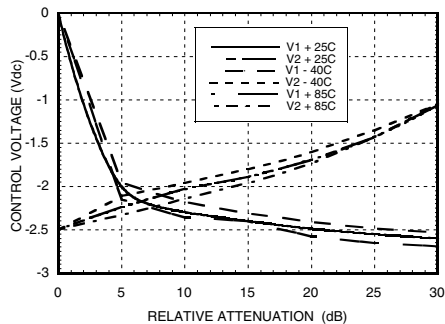

**Relative Attenuation vs. Control Voltage @ 8 GHz**

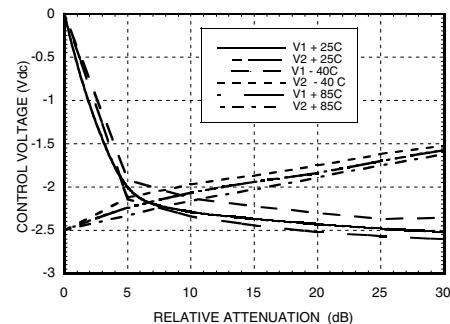

For price, delivery, and to place orders, please contact Hittite Microwave Corporation:  
12 Elizabeth Drive, Chelmsford, MA 01824 Phone: 978-250-3343 Fax: 978-250-3373  
Order Online at [www.hittite.com](http://www.hittite.com)

## GaAs MMIC HERMETIC SMT VOLTAGE-VARIABLE ATTENUATOR, DC - 8 GHz

**Relative Phase**

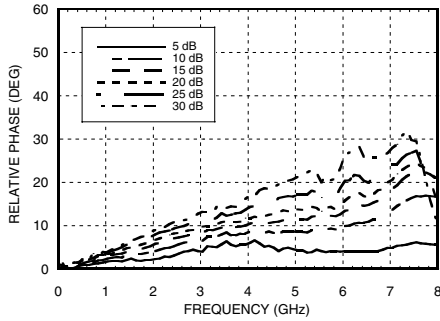

**Input Third Order Intercept vs. Attenuation\***

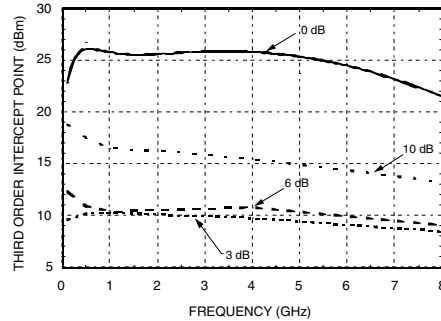

**Input Second Order Intercept vs. Attenuation\***

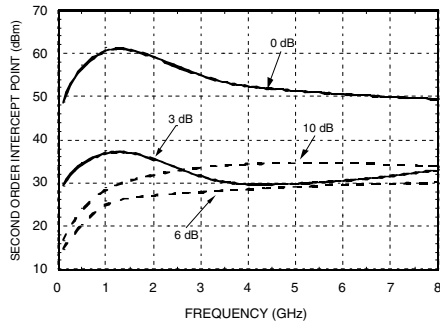

**Second Harmonic vs. Attenuation**

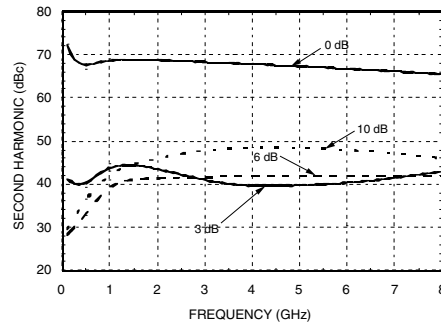

**0.25 dB Compression vs. Attenuation**

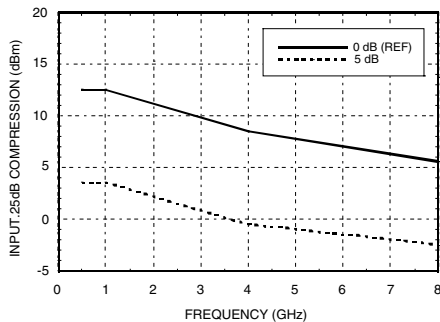

**1 dB Compression vs. Attenuation**

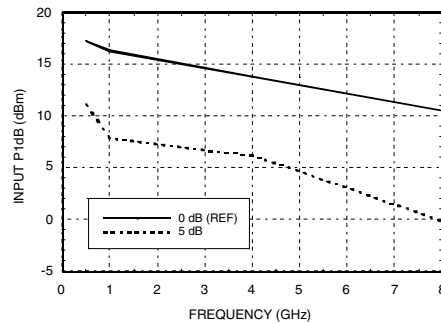

\*Two-tone input power = -8 dBm each tone.

For price, delivery, and to place orders, please contact Hittite Microwave Corporation:  
 12 Elizabeth Drive, Chelmsford, MA 01824 Phone: 978-250-3343 Fax: 978-250-3373  
 Order Online at [www.hittite.com](http://www.hittite.com)

## GaAs MMIC HERMETIC SMT VOLTAGE-VARIABLE ATTENUATOR, DC - 8 GHz

### Absolute Maximum Ratings

RF Input Power	+18 dBm
Control Voltage Range	+1.0 to -5.0 Vdc
Storage Temperature	-65 to +150 °C
Operating Temperature	-40 to +85 °C

### Outline Drawing

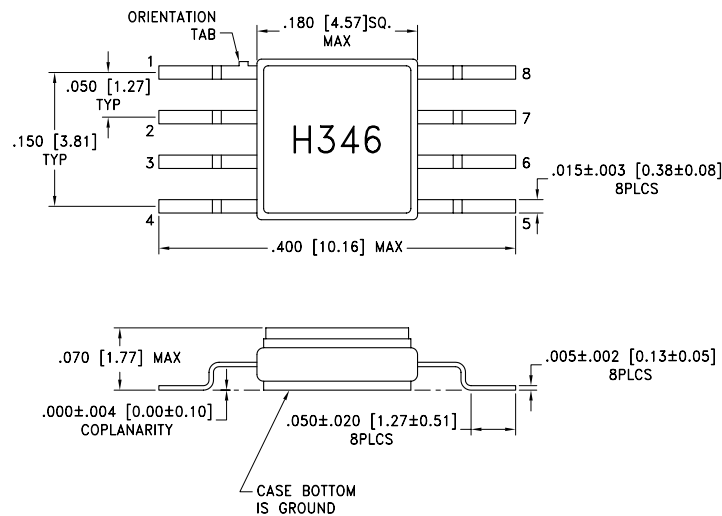



NOTES:

1. PACKAGE MATERIAL: ALUMINA LOADED BOROSILICATE GLASS.
2. LEAD, BASE, COVER MATERIAL: KOVAR™ (#7052 CORNING).
3. PLATING: ELECTROLYTIC GOLD 50 MICROINCHES MIN., OVER ELECTROLYTIC NICKEL 50 MICROINCHES MIN.
4. DIMENSIONS ARE IN INCHES [MILLIMETERS].
5. TOLERANCES: ±.005 [0.13] UNLESS OTHERWISE SPECIFIED.
6. ALL GROUND LEADS AND GROUND PADDLE MUST BE SOLDERED TO PCB RF GROUND.

For price, delivery, and to place orders, please contact Hittite Microwave Corporation:  
 12 Elizabeth Drive, Chelmsford, MA 01824 Phone: 978-250-3343 Fax: 978-250-3373  
 Order Online at [www.hittite.com](http://www.hittite.com)

## GaAs MMIC HERMETIC SMT VOLTAGE-VARIABLE ATTENUATOR, DC - 8 GHz

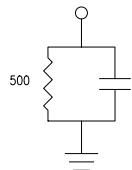
### Pin Descriptions

Pin Number	Function	Description	Interface Schematic
1, 8	RF1, RF2	This pin is DC coupled and matched to 50 Ohm. Blocking capacitors are required if RF line potential is not equal to 0V.	
2, 7	GND	This pin must be DC grounded.	
3, 6	V2, V1	Control Input (Master).	
4	I	Control Input (Slave).	
5	O	This pin must have an external 500 Ohm resistor to ground.	

9

ATTENUATORS - SMT

### Single-Line Control Driver

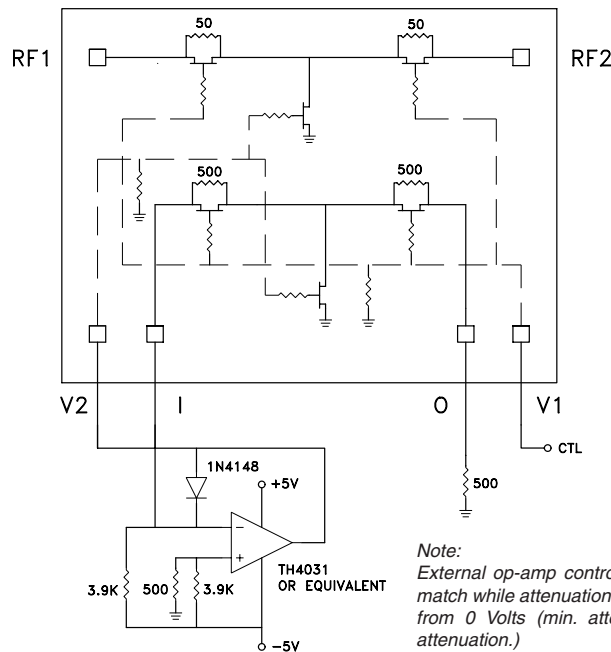

Note:  
External op-amp control circuit maintains impedance match while attenuation is varied. Input control ranges from 0 Volts (min. attenuation) to -2.5 Volts (max. attenuation.)

For price, delivery, and to place orders, please contact Hittite Microwave Corporation:  
12 Elizabeth Drive, Chelmsford, MA 01824 Phone: 978-250-3343 Fax: 978-250-3373  
Order Online at [www.hittite.com](http://www.hittite.com)

## GaAs MMIC HERMETIC SMT VOLTAGE-VARIABLE ATTENUATOR, DC - 8 GHz

### Evaluation PCB

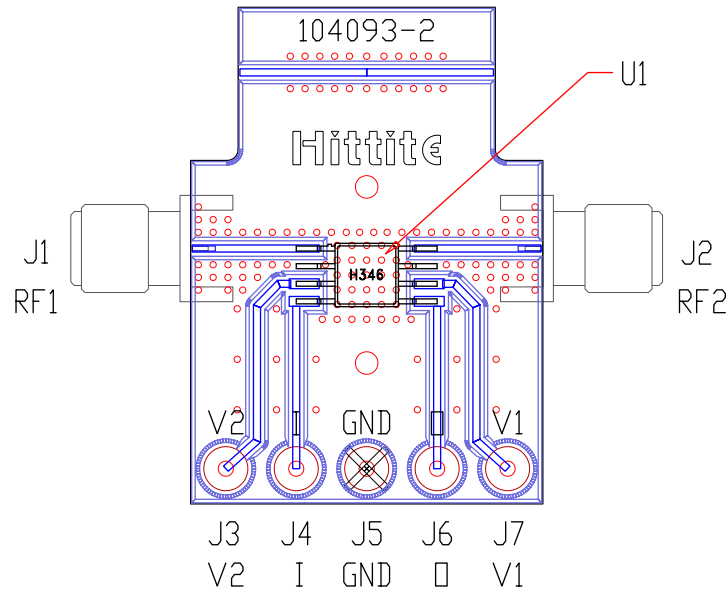

The circuit board used in the final application should be generated with proper RF circuit design techniques. Signal lines at the RF ports should be 50 ohm impedance and the package ground leads and package bottom should be connected directly to the PCB RF ground plane, similar to that shown above. The evaluation circuit board shown above is available from Hittite Microwave Corporation upon request.

### List of Material

Item	Description
J1 - J2	PC Mount SMA RF Connector
J3 - J7	DC PIN
U1	HMC346G8
PCB*	104093-2 Eval Board
*Circuit Board Material: Rogers 4350	