

#### 8CH HIGH-VOLTAGE SOURCE DRIVER

The KID65783AP/AF is comprised of eight source current transistor array. This driver is specifically designed for fluorescent display applications. Applications include relay, hammer and lamp drivers.

#### FEATURES

- High Output Voltage :  $V_{CC}=50V(\text{Min.})$ .
- Output Current (Single Output)  $I_{OUT} : -500mA(\text{Min.})$ .
- Output Clamp Diodes.
- Single Supply Voltage.
- Input Compatible With Various Types of Logic.
- Package Type-AP : DIP-18pin.
- Package Type AF : FLP-20pin.

TYPE	DESIGNATION
KID65783AP/AF	TTL, 5V CMOS

#### PIN CONNECTION (TOP VIEW)

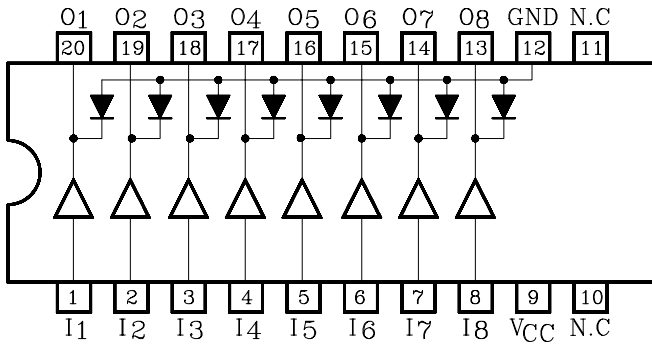

#### SCHEMATICS (EACH DRIVER)

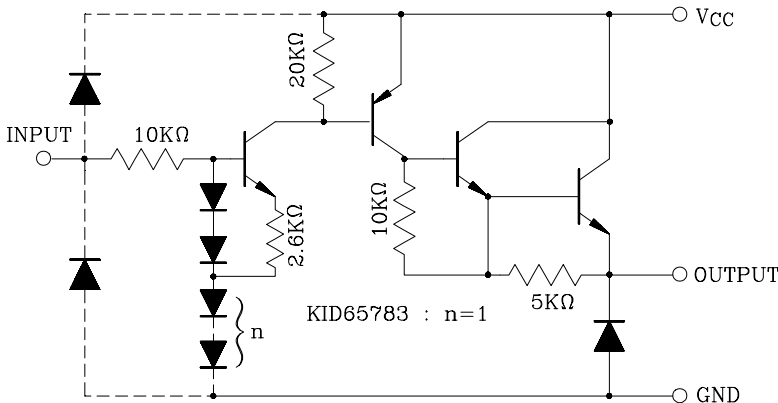

(Note) The input and output parasitic diodes cannot be used as clamp diodes.

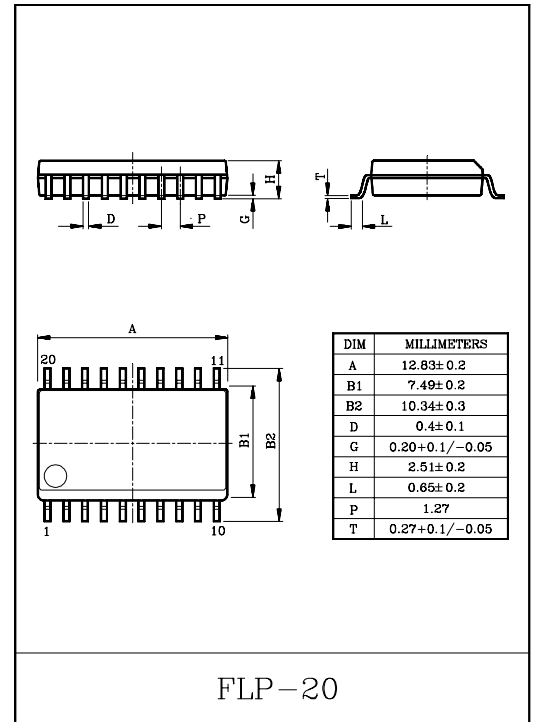
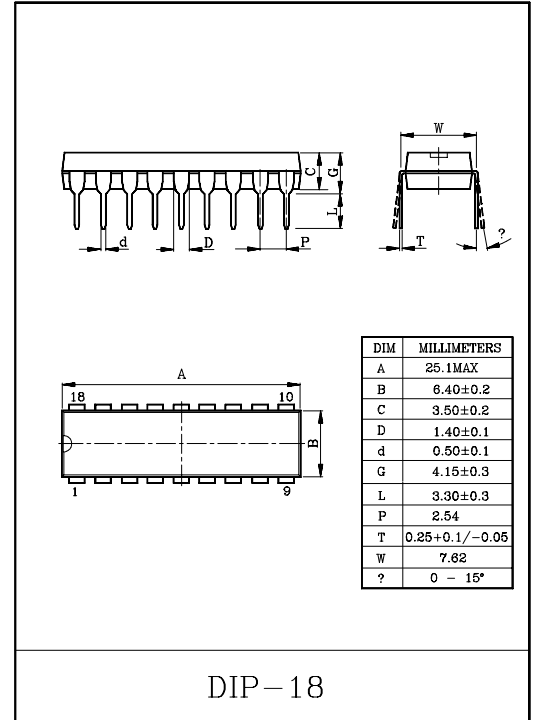

# KID65783AP/AF

## MAXIMUM RATINGS (Ta=25°C)

CHARACTERISTIC	SYMBOL	RATING	UNIT
Supply Voltage	V <sub>CC</sub>	50	V
Output Current	I <sub>OUT</sub>	-500	mA/ch
Input Voltage	V <sub>IN</sub>	15	V
Clamp Diode Reverse Voltage	V <sub>R</sub>	50	V
Clamp Diode Forward Current	I <sub>F</sub>	500	mA
Power Dissipation	AP	1.47	W
	AF	0.96	
Operating Temperature	T <sub>opr</sub>	-40~85	°C
Storage Temperature	T <sub>stg</sub>	-55~150	°C

Note) Delated above 25°C in the proportion of 11.7W/°C(AP Type),  
7.7W/°C(AF Type).

## RECOMMENDED OPERATING CONDITIONS (Ta=-40~85°C)

CHARACTERISTIC	SYMBOL	TEST CONDITION	MIN.	TYP.	MAX.	UNIT	
Supply Voltage	V <sub>CC</sub>	-	-	-	50	V	
Output Current	AP	Ta=85°C Tj=120°C Tp <sub>w</sub> =25mS	Duty=10% 8 Circuits	-	-	-260	mA/ch
			Duty=50% 8 Circuits	-	-	-59	
	AF		Duty=10% 8 Circuits	-	-	-180	
			Duty=50% 8 Circuits	-	-	-38	
Input Voltage	V <sub>IN</sub>	-	-	-	12	V	
Input Voltage	Output ON	V <sub>IN (ON)</sub>	-	2.0	5.0	15	V
	Output OFF	V <sub>IN (OFF)</sub>	-	0	-	0.8	
Clamp Diode Reverse Voltage	AP	V <sub>R</sub>	-	-	-	50	V
	AF			-	-	35	
Clamp Diode Forward Current	I <sub>F</sub>	-	-	-	400	mA	
Power Dissipation	AP	P <sub>D</sub>	-	-	-	0.52	W
	AF			-	-	0.35	

# KID65783AP/AF

## ELECTRICAL CHARACTERISTICS (Ta=25°C)

CHARACTERISTIC	SYMBOL	TEST CIRCUIT	TEST CONDITION	MIN.	TYP.	MAX.	UNIT
Output Leakage Current	$I_{CEX}$	1	$V_{CC}=V_{CC\ MAX.}$ $V_{IN}=0.4V$ $T_a=25^\circ C$	-	-	100	$\mu A$
Output Saturation Voltage	$V_{CE(sat)}$	2	$V_{IN}=V_{IN(ON)}$ , $I_{OUT}=-350mA$	-	-	2.0	V
			$V_{IN}=V_{IN(ON)}$ , $I_{OUT}=-225mA$	-	-	1.9	
			$V_{IN}=V_{IN(ON)}$ , $I_{OUT}=-100mA$	-	-	1.8	
Input Current	$I_{IN(ON)}$	3	$V_{IN}=2.4V$	-	36	52	$\mu A$
			$V_{IN}=3.85V$	-	180	260	
Input Voltage	$V_{IN(ON)}$	4	$V_{CE}=2.0V$ , $I_{OUT}=-350mA$	-	-	2.0	V
	$V_{IN(OFF)}$		$I_{OUT}=-500\mu A$	0.8	-	-	
Supply Current	$I_{CC(ON)}$	3	$V_{IN}=V_{IN(ON)}$ , $V_{CC}=50V$	-	-	2.5	mA/ch
Clamp Diode Reverse Current	$I_R$	5	$V_R=50V$	-	-	50	$\mu A$
Clamp Diode Forward Voltage	$V_F$	6	$I_F=350mA$	-	-	2.0	V
Turn-On Delay	$t_{ON}$	7	$V_{CC}=V_{CC\ MAX.}$ $R_L=125\Omega$ $C_L=15pF$	-	0.15	-	$\mu S$
Turn-Off Delay	$t_{OFF}$			-	1.8	-	

# KID65783AP/AF

## TEST CIRCUIT

1.  $I_{CEX}$

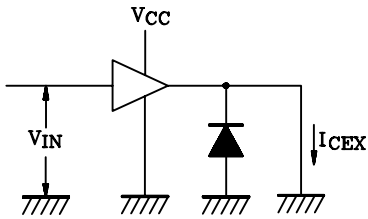

2.  $V_{CE(sat)}$

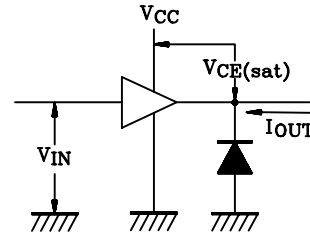

3.  $I_{IN(ON)}$ ,  $I_{CC}$

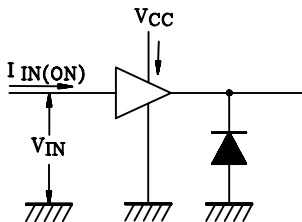

4.  $V_{IN(ON)}$ ,  $V_{IN(OFF)}$

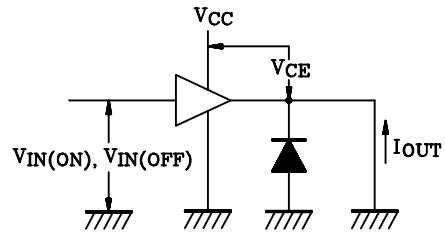

5.  $I_R$

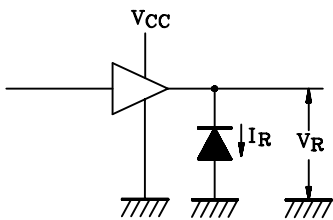

6.  $V_F$

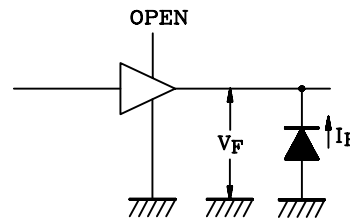

7.  $t_{ON}$ ,  $t_{OFF}$

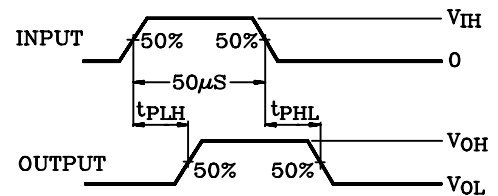
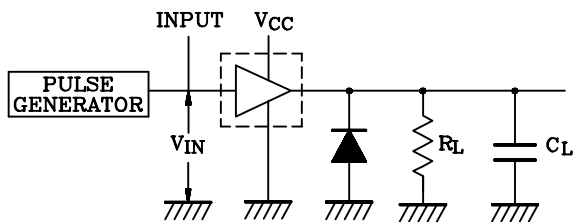

(Note 1) Pulse width 50 $\mu$ S, duty cycle 10%  
Output impedance 50 $\Omega$ ,  $t_r \leq 5$ ns,  $t_f \leq 10$ ns  
(Note 2)  $C_L$  includes probe and jig capacitance

# KID65783AP/AF

$I_{OUT} - V_{IN}$

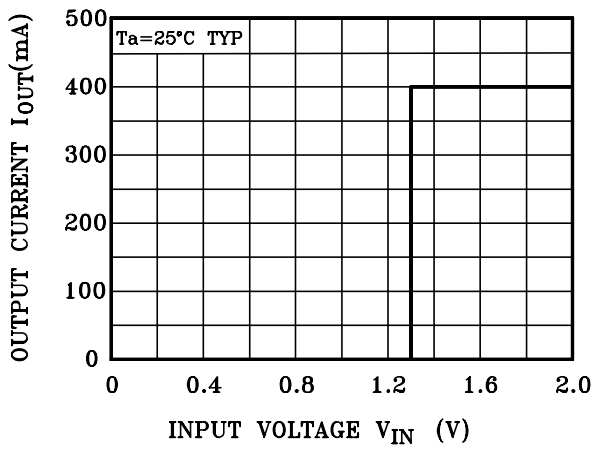

$I_{IN} - V_{IN}$

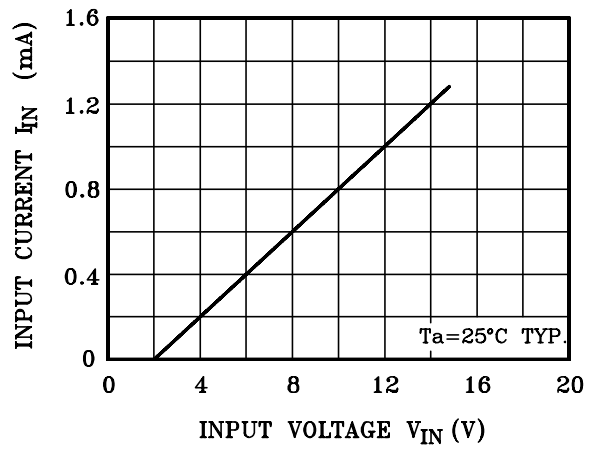

$I_{OUT} - V_{CE(sat)}$

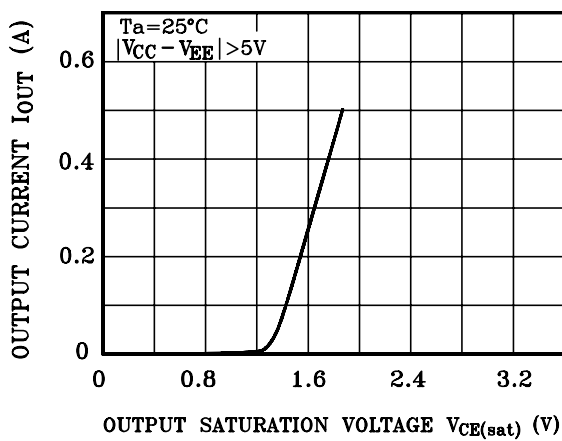

$I_F - V_F$

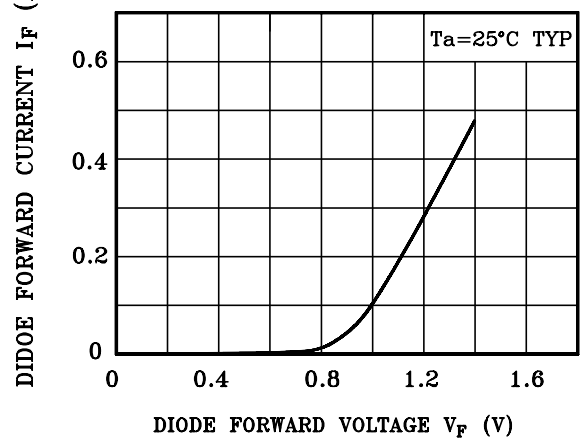

$P_D - T_a$

