

# DATA SHEET

## **BU506; BU506D** Silicon diffused power transistors

Product specification  
Supersedes data of December 1991  
File under Discrete Semiconductors, SC06

1997 Aug 13

# Silicon diffused power transistors

# BU506; BU506D

## DESCRIPTION

High-voltage, high-speed, switching NPN power transistor in a TO-220AB package. The BU506D has an integrated efficiency diode.

## APPLICATIONS

- Horizontal deflection circuits of colour television receivers
- Line-operated switch-mode applications.

## PINNING

PIN	DESCRIPTION
1	base
2	collector; connected to mounting base
3	emitter

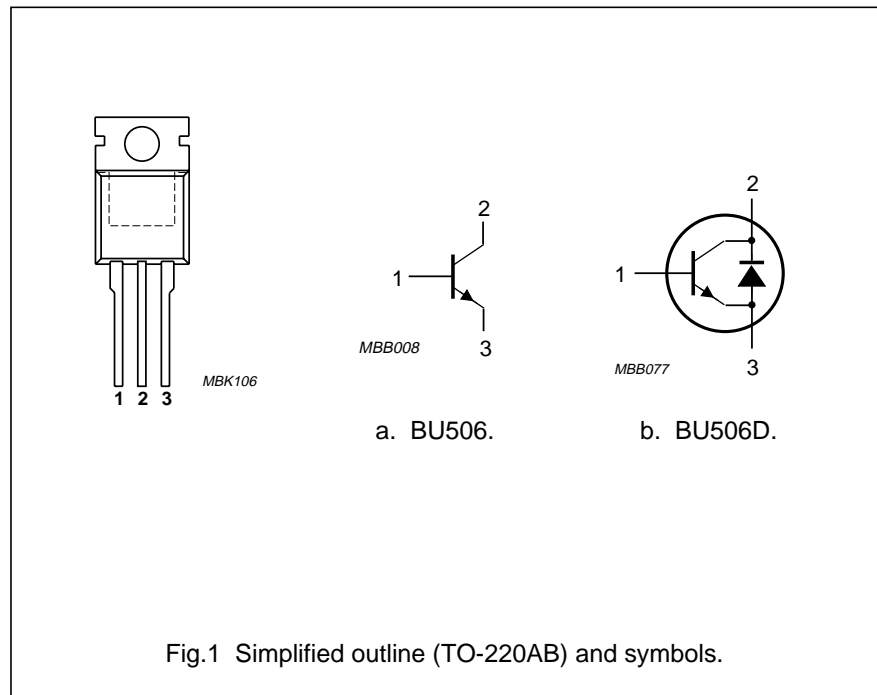

## QUICK REFERENCE DATA

SYMBOL	PARAMETER	CONDITIONS	TYP.	MAX.	UNIT
$V_{CESM}$	collector-emitter peak voltage	$V_{BE} = 0$	–	1500	V
$V_{CEO}$	collector-emitter voltage	open base	–	700	V
$V_{CEsat}$	collector-emitter saturation voltage	$I_C = 3\text{ A}$ ; $I_B = 1.33\text{ A}$ ; see Fig.6	–	1	V
$V_F$	diode forward voltage (BU506D)	$I_F = 3\text{ A}$ ; see Fig.10	1.5	–	V
$I_{Csat}$	collector saturation current		–	3	A
$I_C$	collector current (DC)	see Fig.2	–	5	A
$I_{CM}$	collector current (peak value)	see Fig.2	–	8	A
$P_{tot}$	total power dissipation	$T_{mb} \leq 25\text{ °C}$ ; see Fig.3	–	100	W
$t_f$	fall time	inductive load; see Fig.9	0.7	–	$\mu\text{s}$

## THERMAL CHARACTERISTICS

SYMBOL	PARAMETER	VALUE	UNIT
$R_{th\ j-mb}$	thermal resistance from junction to mounting base	1.25	K/W

## Silicon diffused power transistors

## BU506; BU506D

**LIMITING VALUES**

In accordance with the Absolute Maximum Rating System (IEC 134).

SYMBOL	PARAMETER	CONDITIONS	MIN.	MAX.	UNIT
$V_{CESM}$	collector-emitter peak voltage	$V_{BE} = 0$	–	1500	V
$V_{CEO}$	collector-emitter voltage	open base	–	700	V
$I_{Csat}$	collector saturation current		–	3	A
$I_C$	collector current (DC)	see Fig.2	–	5	A
$I_{CM}$	collector current (peak value)	see Fig.2	–	8	A
$I_B$	base current (DC)		–	3	A
$I_{BM}$	base current (peak value)		–	5	A
$P_{tot}$	total power dissipation	$T_{mb} \leq 25\text{ °C}$ ; see Fig.3	–	100	W
$T_{stg}$	storage temperature		–65	+150	°C
$T_j$	junction temperature		–	150	°C

**CHARACTERISTICS** $T_j = 25\text{ °C}$  unless otherwise specified.

SYMBOL	PARAMETER	CONDITIONS	MIN.	TYP.	MAX.	UNIT
$V_{CEOsust}$	collector-emitter sustaining voltage	see Figs 4 and 5	700	–	–	V
$V_{CEsat}$	collector-emitter saturation voltage	$I_C = 3\text{ A}$ ; $I_B = 1.33\text{ A}$ ; see Fig.6	–	–	1	V
$V_{BEsat}$	base-emitter saturation voltage	$I_C = 3\text{ A}$ ; $I_B = 1.33\text{ A}$ ; see Fig.7	–	–	1.3	V
$V_F$	diode forward voltage (BU506D)	$I_F = 3\text{ A}$ ; see Fig.10	–	1.5	2.2	V
$I_{CES}$	collector-emitter cut-off current	$V_{CE} = V_{CESmax}$ ; $V_{BE} = 0$ ; note 1	–	–	0.5	mA
		$V_{CE} = V_{CESmax}$ ; $V_{BE} = 0$ ; $T_j = 125\text{ °C}$ ; note 1	–	–	1	mA
$I_{EBO}$	emitter-base cut-off current	$V_{EB} = 6\text{ V}$ ; $I_C = 0$	–	–	10	mA
$h_{FE}$	DC current gain	$V_{CE} = 5\text{ V}$ ; $I_C = 100\text{ mA}$ ; see Fig.8	6	13	30	
<b>Switching times in horizontal deflection circuit (see Fig.9)</b>						
$t_s$	storage time	$I_{CM} = 3\text{ A}$ ; $I_{B(end)} = 1\text{ A}$ ; $L_B = 12\text{ }\mu\text{H}$	–	6.5	–	$\mu\text{s}$
$t_f$	fall time	$I_{CM} = 3\text{ A}$ ; $I_{B(end)} = 1\text{ A}$ ; $L_B = 12\text{ }\mu\text{H}$	–	0.7	–	$\mu\text{s}$

**Note**

1. Measured with a half-sinewave voltage (curve tracer).

Silicon diffused power transistors

BU506; BU506D

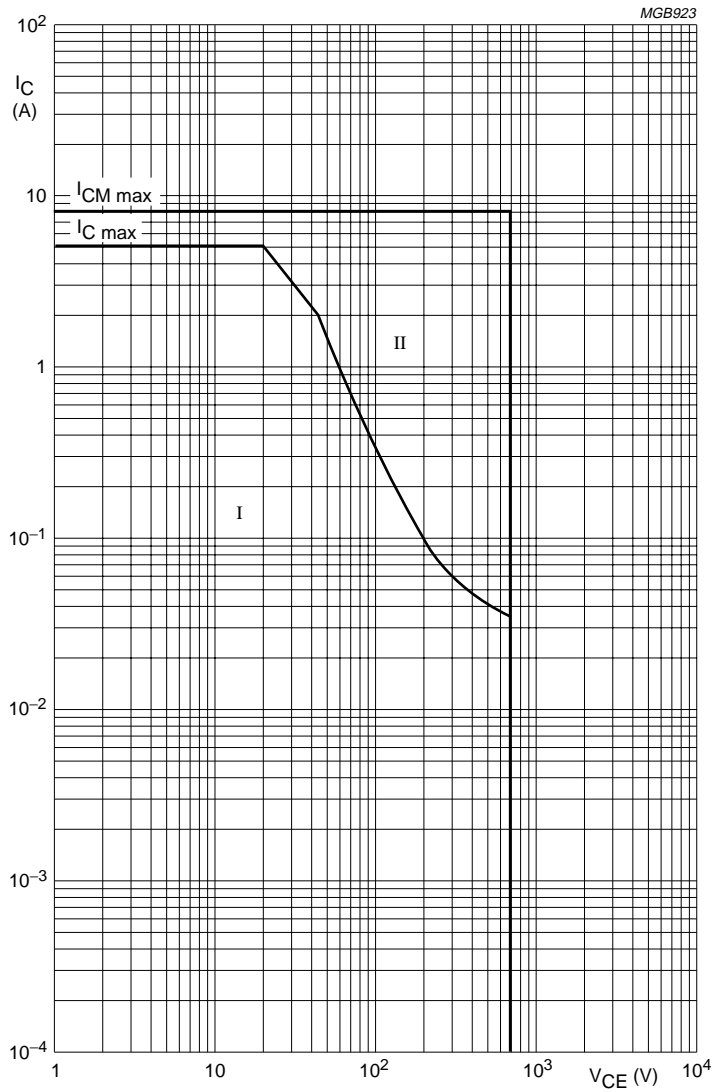

$T_{mb} = 25\ ^\circ\text{C}$ .

I - Region of permissible DC operation.

II - Permissible extension for repetitive pulse operation.

Fig.2 Forward bias SOAR.

Silicon diffused power transistors

BU506; BU506D

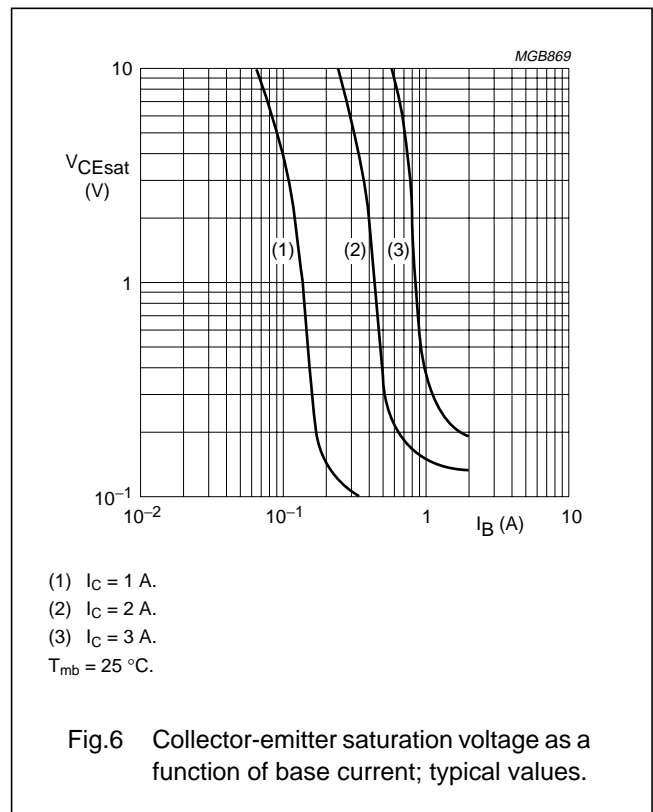
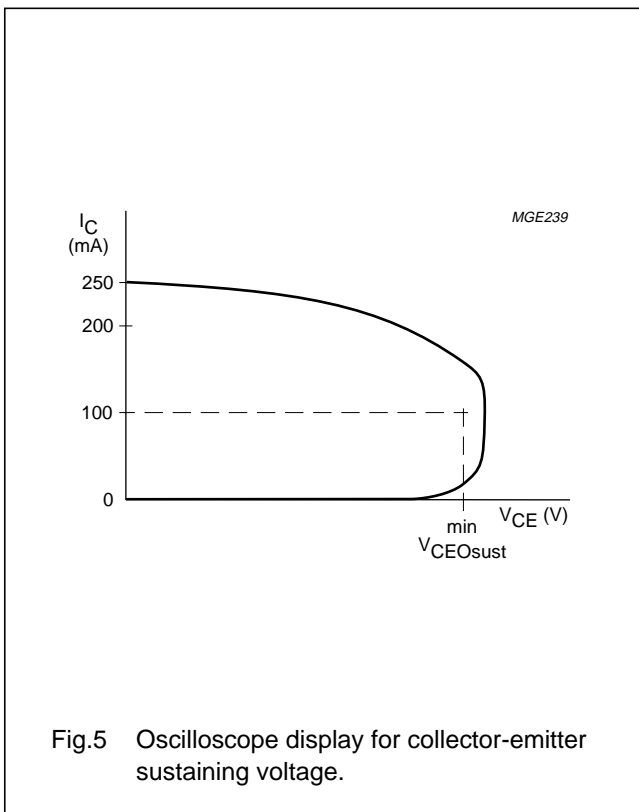
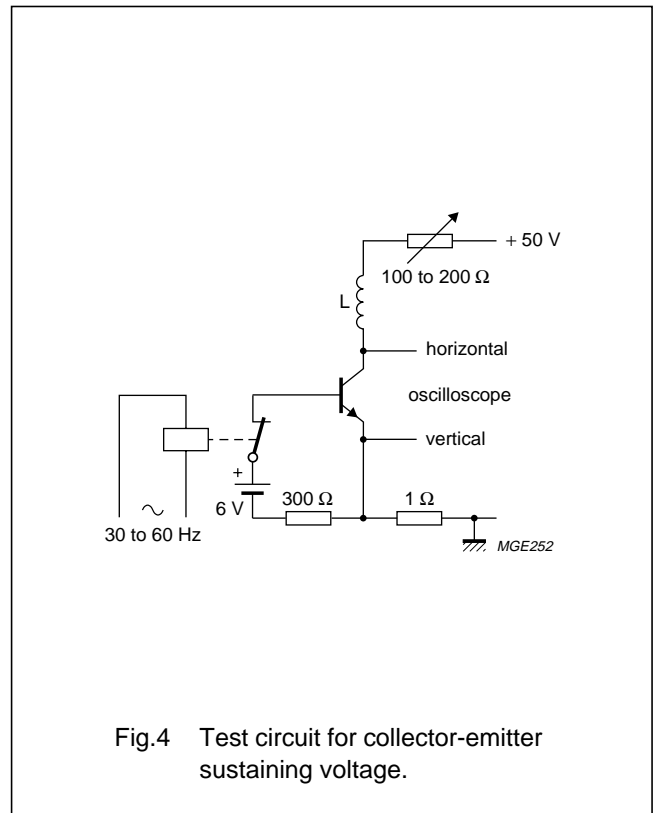
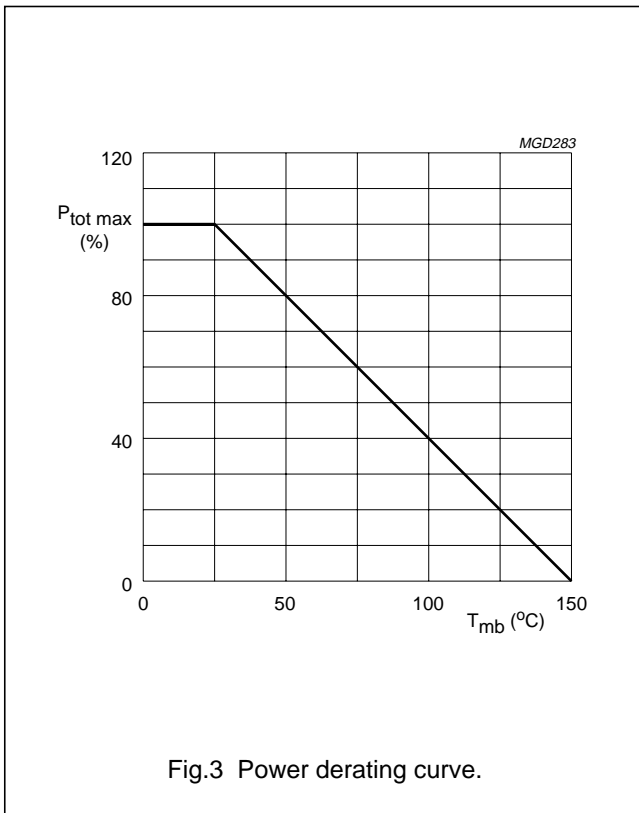

Silicon diffused power transistors

BU506; BU506D

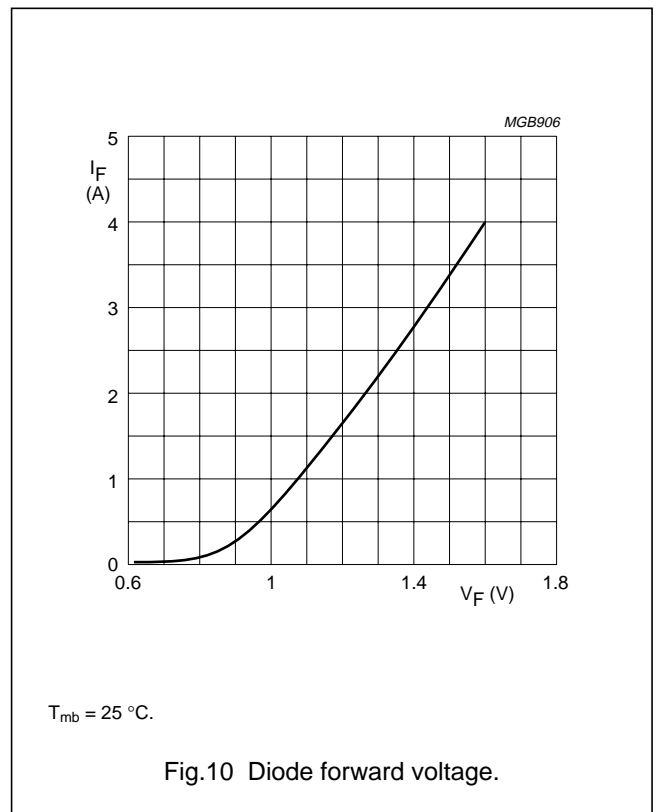
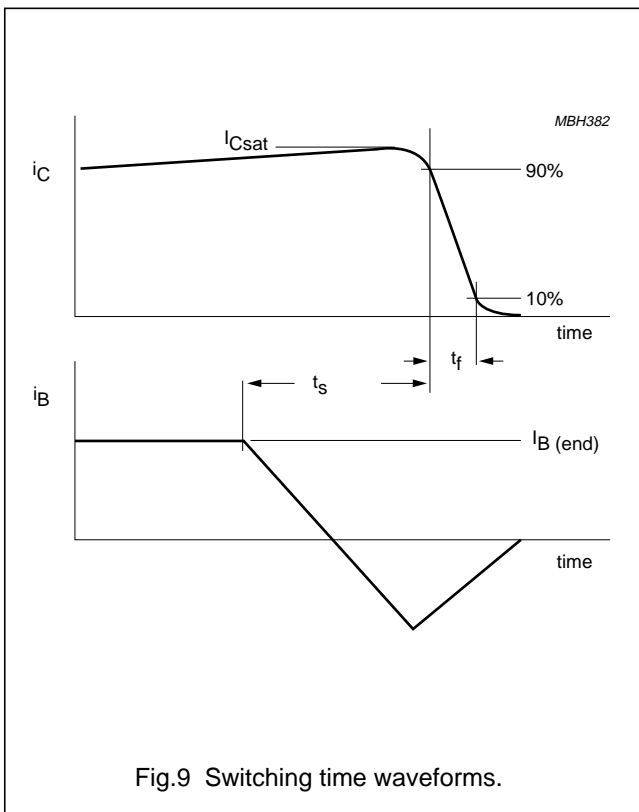
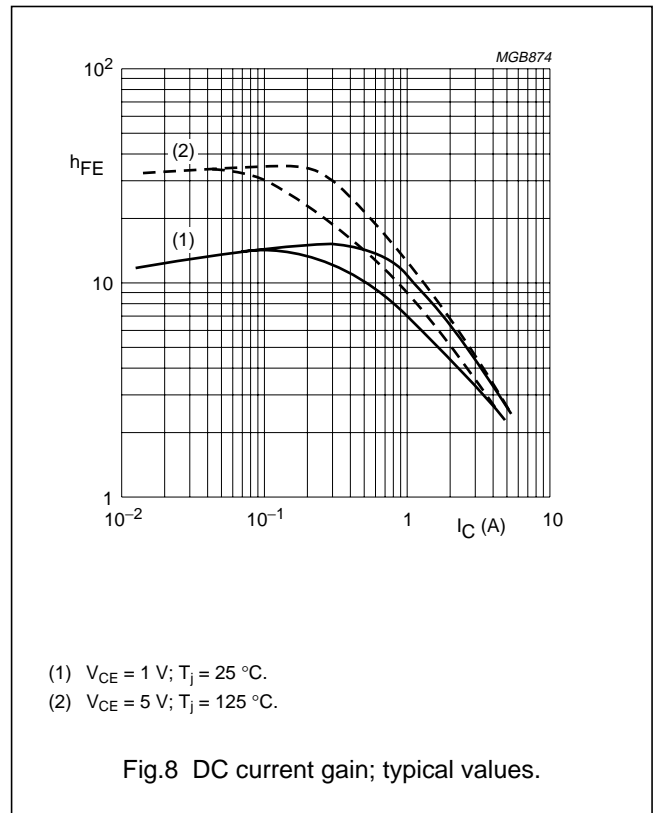
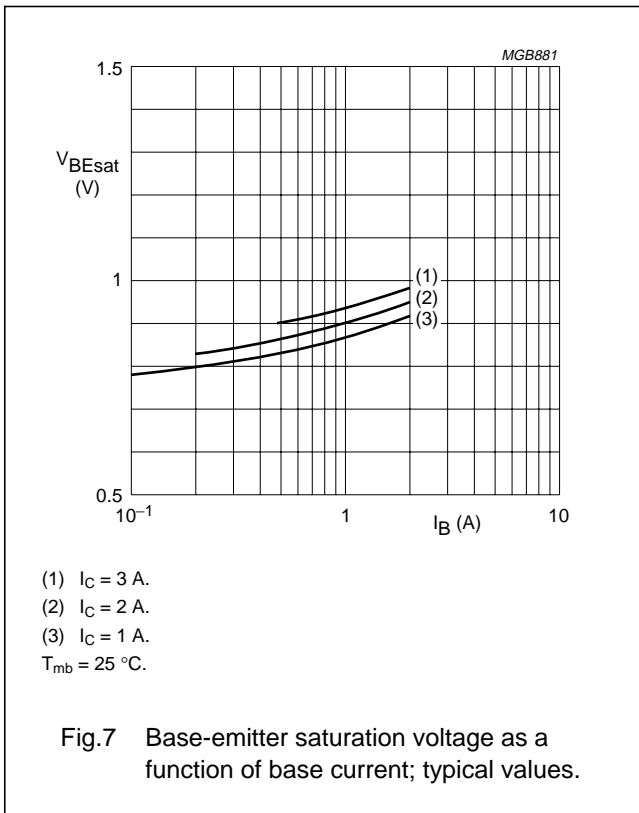

Silicon diffused power transistors

BU506; BU506D

PACKAGE OUTLINE

Plastic single-ended package; heatsink mounted; 1 mounting hole; 3-lead TO-220

SOT78

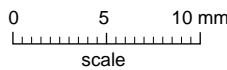
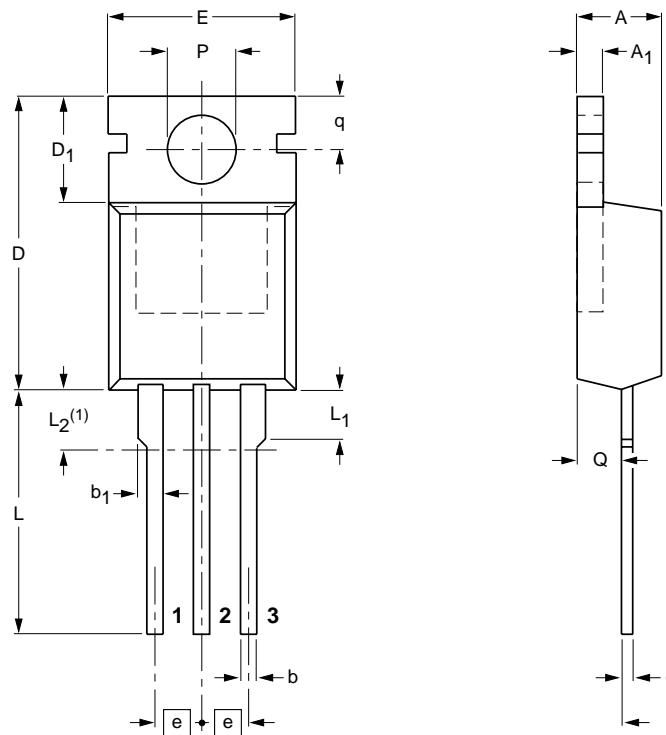

DIMENSIONS (mm are the original dimensions)

UNIT	A	A <sub>1</sub>	b	b <sub>1</sub>	c	D	D <sub>1</sub>	E	e	L	L <sub>1</sub>	L <sub>2</sub> <sup>(1)</sup> max.	P	q	Q
mm	4.5 4.1	1.39 1.27	0.9 0.7	1.3 1.0	0.7 0.4	15.8 15.2	6.4 5.9	10.3 9.7	2.54	15.0 13.5	3.30 2.79	3.0	3.8 3.6	3.0 2.7	2.6 2.2

Note

1. Terminals in this zone are not tinned.

OUTLINE VERSION	REFERENCES				EUROPEAN PROJECTION	ISSUE DATE
	IEC	JEDEC	EIAJ			
SOT78		TO-220				97-06-11

---

**Silicon diffused power transistors****BU506; BU506D**

---

**DEFINITIONS**

<b>Data sheet status</b>	
Objective specification	This data sheet contains target or goal specifications for product development.
Preliminary specification	This data sheet contains preliminary data; supplementary data may be published later.
Product specification	This data sheet contains final product specifications.
<b>Limiting values</b>	
Limiting values given are in accordance with the Absolute Maximum Rating System (IEC 134). Stress above one or more of the limiting values may cause permanent damage to the device. These are stress ratings only and operation of the device at these or at any other conditions above those given in the Characteristics sections of the specification is not implied. Exposure to limiting values for extended periods may affect device reliability.	
<b>Application information</b>	
Where application information is given, it is advisory and does not form part of the specification.	

**LIFE SUPPORT APPLICATIONS**

These products are not designed for use in life support appliances, devices, or systems where malfunction of these products can reasonably be expected to result in personal injury. Philips customers using or selling these products for use in such applications do so at their own risk and agree to fully indemnify Philips for any damages resulting from such improper use or sale.



Silicon diffused power transistors

BU506; BU506D

---

**NOTES**

Silicon diffused power transistors

BU506; BU506D

---

**NOTES**

Silicon diffused power transistors

BU506; BU506D

---

**NOTES**

# Philips Semiconductors – a worldwide company

**Argentina:** see South America

**Australia:** 34 Waterloo Road, NORTH RYDE, NSW 2113,  
Tel. +61 2 9805 4455, Fax. +61 2 9805 4466

**Austria:** Computerstr. 6, A-1101 WIEN, P.O. Box 213, Tel. +43 160 1010,  
Fax. +43 160 101 1210

**Belarus:** Hotel Minsk Business Center, Bld. 3, r. 1211, Volodarski Str. 6,  
220050 MINSK, Tel. +375 172 200 733, Fax. +375 172 200 773

**Belgium:** see The Netherlands

**Brazil:** see South America

**Bulgaria:** Philips Bulgaria Ltd., Energoproject, 15th floor,  
51 James Bourchier Blvd., 1407 SOFIA,  
Tel. +359 2 689 211, Fax. +359 2 689 102

**Canada:** PHILIPS SEMICONDUCTORS/COMPONENTS,  
Tel. +1 800 234 7381

**China/Hong Kong:** 501 Hong Kong Industrial Technology Centre,  
72 Tat Chee Avenue, Kowloon Tong, HONG KONG,  
Tel. +852 2319 7888, Fax. +852 2319 7700

**Colombia:** see South America

**Czech Republic:** see Austria

**Denmark:** Prags Boulevard 80, PB 1919, DK-2300 COPENHAGEN S,  
Tel. +45 32 88 2636, Fax. +45 31 57 0044

**Finland:** Sinikalliontie 3, FIN-02630 ESPOO,  
Tel. +358 9 615800, Fax. +358 9 61580920

**France:** 4 Rue du Port-aux-Vins, BP317, 92156 SURESNES Cedex,  
Tel. +33 1 40 99 6161, Fax. +33 1 40 99 6427

**Germany:** Hammerbrookstraße 69, D-20097 HAMBURG,  
Tel. +49 40 23 53 60, Fax. +49 40 23 536 300

**Greece:** No. 15, 25th March Street, GR 17778 TAVROS/ATHENS,  
Tel. +30 1 4894 339/239, Fax. +30 1 4814 240

**Hungary:** see Austria

**India:** Philips INDIA Ltd, Band Box Building, 2nd floor,  
254-D, Dr. Annie Besant Road, Worli, MUMBAI 400 025,  
Tel. +91 22 493 8541, Fax. +91 22 493 0966

**Indonesia:** see Singapore

**Ireland:** Newstead, Clonskeagh, DUBLIN 14,  
Tel. +353 1 7640 000, Fax. +353 1 7640 200

**Israel:** RAPAC Electronics, 7 Kehilat Saloniki St, PO Box 18053,  
TEL AVIV 61180, Tel. +972 3 645 0444, Fax. +972 3 649 1007

**Italy:** PHILIPS SEMICONDUCTORS, Piazza IV Novembre 3,  
20124 MILANO, Tel. +39 2 6752 2531, Fax. +39 2 6752 2557

**Japan:** Philips Bldg 13-37, Kohnan 2-chome, Minato-ku, TOKYO 108,  
Tel. +81 3 3740 5130, Fax. +81 3 3740 5077

**Korea:** Philips House, 260-199 Itaewon-dong, Yongsan-ku, SEOUL,  
Tel. +82 2 709 1412, Fax. +82 2 709 1415

**Malaysia:** No. 76 Jalan Universiti, 46200 PETALING JAYA, SELANGOR,  
Tel. +60 3 750 5214, Fax. +60 3 757 4880

**Mexico:** 5900 Gateway East, Suite 200, EL PASO, TEXAS 79905,  
Tel. +9-5 800 234 7381

**Middle East:** see Italy

**Netherlands:** Postbus 90050, 5600 PB EINDHOVEN, Bldg. VB,  
Tel. +31 40 27 82785, Fax. +31 40 27 88399

**New Zealand:** 2 Wagener Place, C.P.O. Box 1041, AUCKLAND,  
Tel. +64 9 849 4160, Fax. +64 9 849 7811

**Norway:** Box 1, Manglerud 0612, OSLO,  
Tel. +47 22 74 8000, Fax. +47 22 74 8341

**Philippines:** Philips Semiconductors Philippines Inc.,  
106 Valero St. Salcedo Village, P.O. Box 2108 MCC, MAKATI,  
Metro MANILA, Tel. +63 2 816 6380, Fax. +63 2 817 3474

**Poland:** Ul. Lukiska 10, PL 04-123 WARSZAWA,  
Tel. +48 22 612 2831, Fax. +48 22 612 2327

**Portugal:** see Spain

**Romania:** see Italy

**Russia:** Philips Russia, Ul. Usatcheva 35A, 119048 MOSCOW,  
Tel. +7 095 755 6918, Fax. +7 095 755 6919

**Singapore:** Lorong 1, Toa Payoh, SINGAPORE 1231,  
Tel. +65 350 2538, Fax. +65 251 6500

**Slovakia:** see Austria

**Slovenia:** see Italy

**South Africa:** S.A. PHILIPS Pty Ltd., 195-215 Main Road Martindale,  
2092 JOHANNESBURG, P.O. Box 7430 Johannesburg 2000,  
Tel. +27 11 470 5911, Fax. +27 11 470 5494

**South America:** Rua do Rocio 220, 5th floor, Suite 51,  
04552-903 São Paulo, SÃO PAULO - SP, Brazil,  
Tel. +55 11 821 2333, Fax. +55 11 829 1849

**Spain:** Balmes 22, 08007 BARCELONA,  
Tel. +34 3 301 6312, Fax. +34 3 301 4107

**Sweden:** Kottbygatan 7, Akalla, S-16485 STOCKHOLM,  
Tel. +46 8 632 2000, Fax. +46 8 632 2745

**Switzerland:** Allmendstrasse 140, CH-8027 ZÜRICH,  
Tel. +41 1 488 2686, Fax. +41 1 481 7730

**Taiwan:** Philips Semiconductors, 6F, No. 96, Chien Kuo N. Rd., Sec. 1,  
TAIPEI, Taiwan Tel. +886 2 2134 2865, Fax. +886 2 2134 2874

**Thailand:** PHILIPS ELECTRONICS (THAILAND) Ltd.,  
209/2 Sanpavuth-Bangna Road Prakanong, BANGKOK 10260,  
Tel. +66 2 745 4090, Fax. +66 2 398 0793

**Turkey:** Talatpasa Cad. No. 5, 80640 GÜLTEPE/ISTANBUL,  
Tel. +90 212 279 2770, Fax. +90 212 282 6707

**Ukraine:** PHILIPS UKRAINE, 4 Patrice Lumumba str., Building B, Floor 7,  
252042 KIEV, Tel. +380 44 264 2776, Fax. +380 44 268 0461

**United Kingdom:** Philips Semiconductors Ltd., 276 Bath Road, Hayes,  
MIDDLESEX UB3 5BX, Tel. +44 181 730 5000, Fax. +44 181 754 8421

**United States:** 811 East Arques Avenue, SUNNYVALE, CA 94088-3409,  
Tel. +1 800 234 7381

**Uruguay:** see South America

**Vietnam:** see Singapore

**Yugoslavia:** PHILIPS, Trg N. Pasica 5/v, 11000 BEOGRAD,  
Tel. +381 11 625 344, Fax. +381 11 635 777

**For all other countries apply to:** Philips Semiconductors, Marketing & Sales Communications,  
Building BE-p, P.O. Box 218, 5600 MD EINDHOVEN, The Netherlands, Fax. +31 40 27 24825

**Internet:** <http://www.semiconductors.philips.com>

© Philips Electronics N.V. 1997

SCA55

All rights are reserved. Reproduction in whole or in part is prohibited without the prior written consent of the copyright owner.

The information presented in this document does not form part of any quotation or contract, is believed to be accurate and reliable and may be changed without notice. No liability will be accepted by the publisher for any consequence of its use. Publication thereof does not convey nor imply any license under patent- or other industrial or intellectual property rights.

Printed in The Netherlands

137067/00/01/pp12

Date of release: 1997 Aug 13

Document order number: 9397 750 02711

*Let's make things better.*

**Philips  
Semiconductors**



**PHILIPS**