

NPN Silicon Planar Transistors

BDW 25
BDY 12
BDY 13

SIEMENS AKTIENGESELLSCHAFT .433 D

BDW 25, BDY 12, and BDY 13 are epitaxial NPN silicon planar power transistors in SOT 9 case (9 A 2 DIN 41875). The collector is electrically connected to the case. In order to ensure insulated fixing of the transistors on the chassis, a mica washer, each, and two insulating nipples are provided for. These have to be ordered separately. The transistors are particularly suitable for use in high Q AF output stages and as switches.

Type	Ordering code
BDW 25	Q62702-D378
BDW 25-4	Q62702-D378-V4
BDW 25-6	Q62702-D378-V2
BDW 25-10	Q62702-D378-V1
BDY 12	Q60204-Y12
BDY 12-6	Q60204-Y12-B
BDY 12-10	Q60204-Y12-C
BDY 12-16	Q60204-Y12-D
BDY 13	Q60204-Y13
BDY 13-6	Q60204-Y13-B
BDY 13-10	Q60204-Y13-C
BDY 13-16	Q60204-Y13-D
Mica washer	Q62901-B16-A
Insulating nipple	Q62901-B13-C

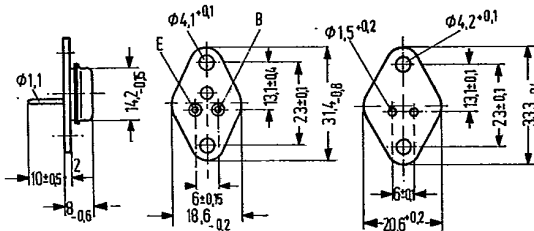

Approx. weight 8.3 g Dimensions in mm Mica washer dry: $R_{th} = 2.5 \text{ K/W}$ greased: $R_{th} = 1 \text{ K/W}$

Maximum ratings

Collector emitter voltage
Collector-base voltage
Emitter-base voltage
Collector current
Emitter current
Emitter peak current¹⁾
Base current
Base peak current¹⁾
Junction temperature
Storage temperature range
Total power dissipation
($T_{case} = 45 \text{ °C}$; $V_{CE} < 13 \text{ V}$)

	BDW 25	BDY 12	BDY 13	
V_{CEO}	125	40	60	V
V_{CBO}	130	60	80	V
V_{EBO}	5	5	5	V
I_C	5	5	5	A
I_E	3.5	-	-	A
I_{EM}	6	-	-	A
I_B	0.5	0.3	0.3	A
I_{BM}	1	-	-	A
T_j	175	175	175	°C
T_{stg}		-65 to +125		°C
P_{tot}	26	26	26	W
R_{thJA}	≤ 85	≤ 85	≤ 85	K/W
R_{thJC}	≤ 5	≤ 5	≤ 5	K/W

Thermal resistance

Junction to ambient air
Junction to case

1) $v \geq 10 \text{ t}_p$; $t_p \leq 10 \text{ ns}$

Static characteristics ($T_{case} = 25^{\circ}C$)

The transistors BDW 25, BDY 12, and BDY 13 are grouped according to the DC current gain h_{FE} at $I_C = 1 A$, $V_{CE} = 1 V$, and marked by numerals of the German DIN-R-5 standard. For the conditions stated below, the following data applies:

Type		BDW 25	BDW 25 BDY 12, BDY 13		BDY 12, BDY 13	BDW 25 BDY 12 BDY 13
h_{FE} group		4	6	10	16	
V_{CE} V	I_C A	h_{FE} I_C/I_B	h_{FE} I_C/I_B	h_{FE} I_C/I_B	h_{FE} I_C/I_B	V_{BE} V
1	0.01	35 (> 15)	55	75	120	
1	1	40 (25 to 60)	63 (40 to 100)	100 (63 to 160)	160 (100 to 250)	<1.2*
2	3	25 (> 10)	40	70	120	<1.4

Static characteristics ($T_{case} = 25^{\circ}C$)

	BDW 25	BDY 12	BDY 13		
Collector-emitter saturation voltage ($I_C = 3 A$; $I_B = 0.3 A$)	V_{CEsat}	<1	<1	<1	V
Base-emitter saturation voltage ($I_C = 3 A$; $I_B = 0.3 A$)	V_{BEsat}	1 (<1.4)	1 (<1.3)	1 (<1.3)	V
Collector cutoff current ($V_{CE} = 80 V$)	I_{CES}	<1	-	-	μA
Collector cutoff current ($V_{CE} = 80 V$; $T_{amb} = 125^{\circ}C$)	I_{CES}	<400	-	-	μA
Collector cutoff current ($V_{CE} = 40 V$)	I_{CES}	-	<1	-	μA
Collector cutoff current ($V_{CE} = 40 V$; $T_{amb} = 125^{\circ}C$)	I_{CES}	-	<400	-	μA
Collector cutoff current ($V_{CE} = 60 V$)	I_{CES}	-	-	<1	μA
Collector cutoff current ($V_{CE} = 60 V$; $T_{amb} = 125^{\circ}C$)	I_{CES}	-	-	<400	μA
Emitter cutoff current ($V_{EBO} = 4 V$)	I_{EBO}	<1	<1	<1	μA

* AQL = 0.65%

Static characteristics ($T_{case} = 25^\circ C$)

	BDW 25	BDY 12	BDY 13	
Collector emitter breakdown voltage ($I_C = 50\text{ mA}$) (Pulse width 200 μs , duty cycle 1%)	$V_{(BR)CEO} > 125$	> 40	> 60	V
Collector base breakdown voltage ($I_C = 100\ \mu A$)	$V_{(BR)CBO} > 130$	> 60	> 80	V
Emitter base breakdown voltage ($I_C = 10\ \mu A$)	$V_{(BR)EBO} > 5$	> 5	> 5	V

Dynamic characteristics ($T_{amb} = 25^\circ C$)

Transition frequency ($I_C = 200\text{ mA}$; $V_{CE} = 10\text{ V}$; $f = 20\text{ MHz}$)	$f_T > 30$	70 (>30)	70 (>30)	MHz
Collector base capacitance ($V_{CB} = 10\text{ V}$; $I_E = 0$; $f = 1\text{ MHz}$)	$C_{CBO} < 70$	35 (<70)	35 (<70)	pF
Switching times ($I_C = 1\text{ A}$; I_{B1} approx. $-I_{B2}$ approx. 50mA)	$t_{on} < 0,3$	$< 0,3$	$< 0,3$	μs
	$t_{off} < 1,5$	$< 1,5$	$< 1,5$	μs
($I_C = 2\text{ A}$; I_{B1} approx. $-I_{B2}$ approx. 200mA)	$t_{on} < 0,5$	-	-	μs
	$t_{off} < 2$	-	-	μs
	$t_s < 1$	-	-	μs

Test circuit for switching times

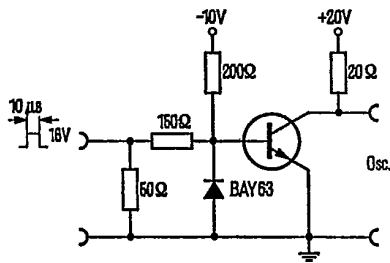

SIEMENS AKTIENGESELLSCHAFT

Total perm. power dissipation versus temperature
 $P_{tot} = f(T_{case}); V_{CE} = \text{parameter}$

BDY 12

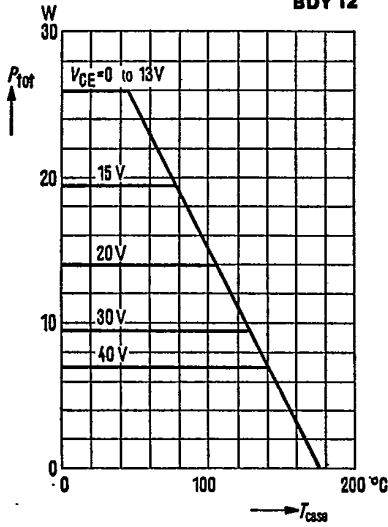

Total perm. power dissipation versus temperature
 $P_{tot} = f(T_{case}); V_{CE} = \text{parameter}$

BDY 13

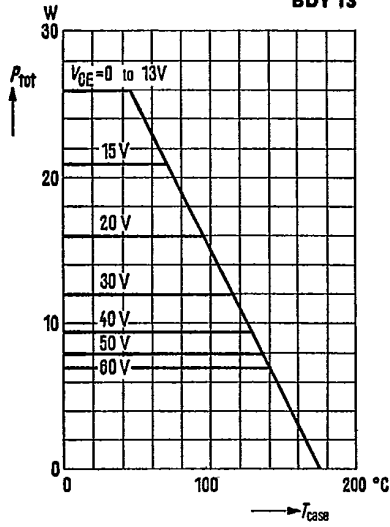

Total perm. power dissipation versus temperature
 $P_{tot} = f(T_{case}); V_{CE} = \text{parameter}$

BDW 25

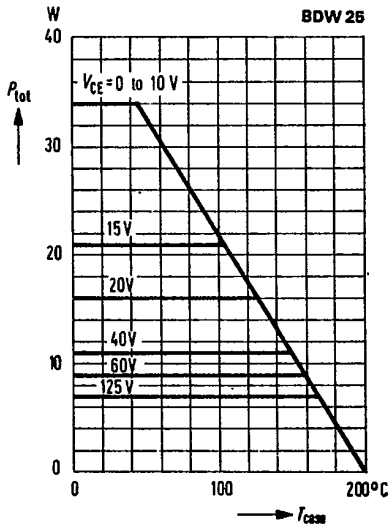

Permissible pulse load
 $r_{thJC} = f(t); v = \text{parameter}$

BDW 25

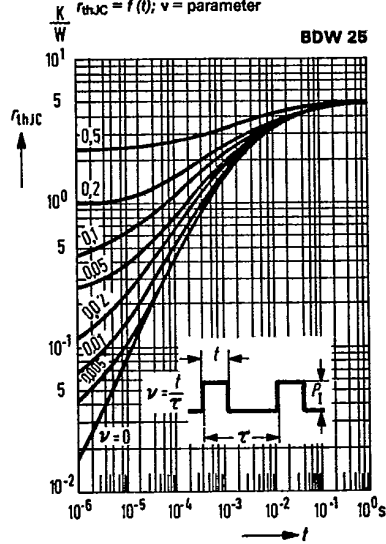

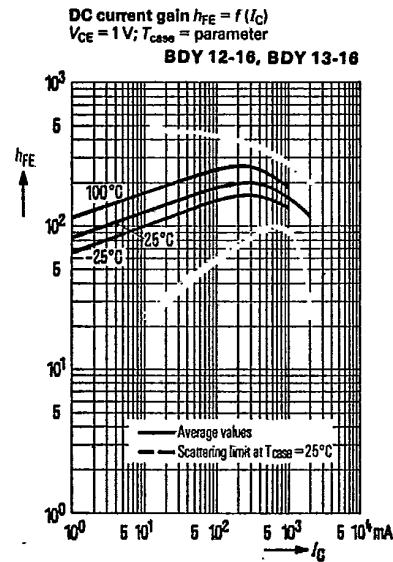
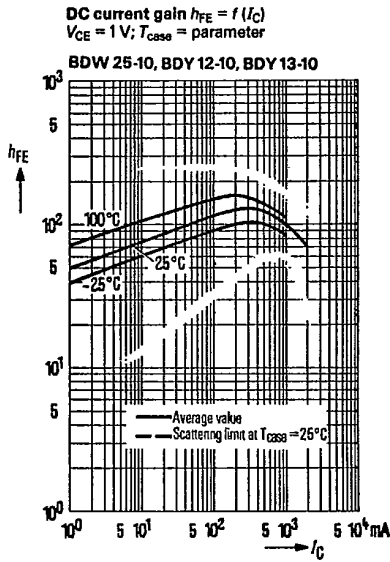
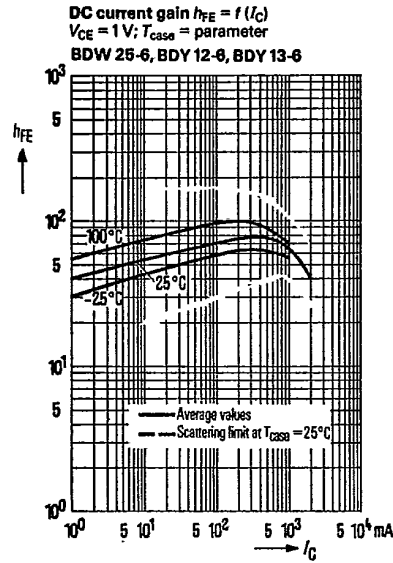
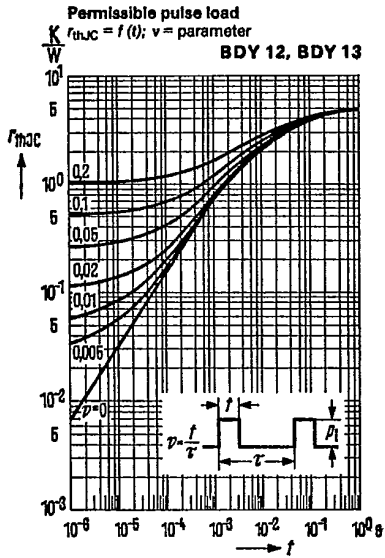

SIEMENS AKTIENGESELLSCHAFT

Output characteristics $I_C = f(V_{CE})$
 $I_B = \text{parameter}$
(common emitter configuration)

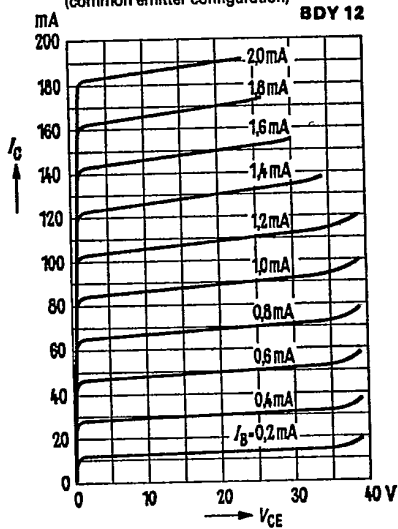

Output characteristics $I_C = f(V_{CE})$
 $I_B = \text{parameter}$
(common emitter configuration)

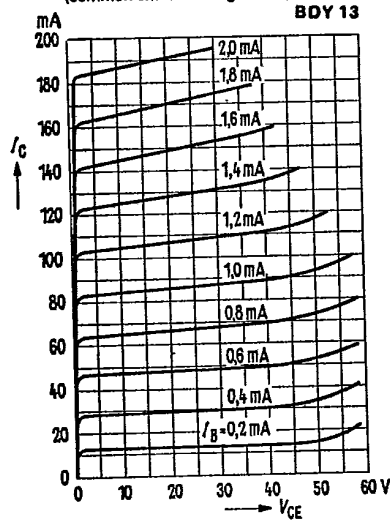

Output characteristics $I_C = f(V_{CE})$
 $I_B = \text{parameter}$
(common emitter configuration)

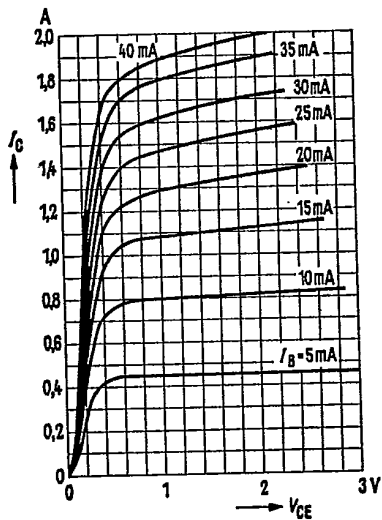

Collector current $I_C = f(V_{BE})$
 $V_{CE} = 1V$

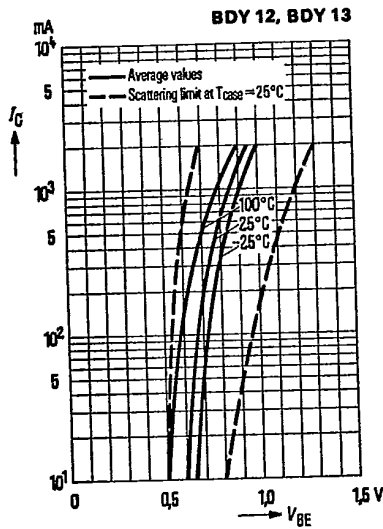

Collector-emitter saturation voltage

$V_{CEsat} = f(I_C)$
 $h_{FE} = 10; T_{case} = \text{parameter}$
(common emitter configuration)

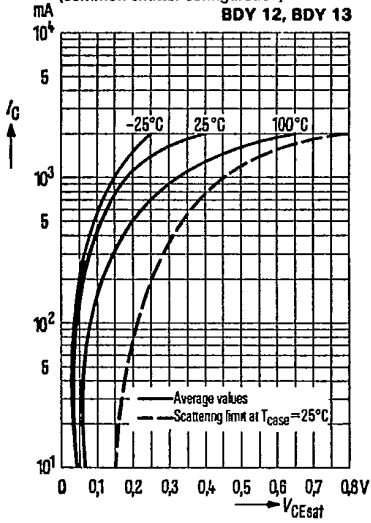

Base-emitter saturation voltage

$V_{BEsat} = f(I_C)$
 $h_{FE} = 10; T_{case} = \text{parameter}$
(common emitter configuration)

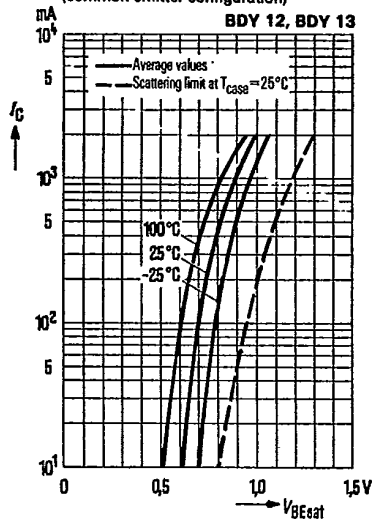

Collector cutoff current versus temperature

$I_{CBO} = f(T_{case})$ for maximum permissible reverse voltage

