

# DATA SHEET

## **PCF84C85A**

**Microcontroller with extended I/O**

Product specification  
Supersedes data of May 1994  
File under Integrated Circuits, IC14

1996 Nov 21

---

**Microcontroller with extended I/O****PCF84C85A**

---

**CONTENTS**

|        |   |
|--------|---|
| 1      | FEATURES  |
| 2      | GENERAL DESCRIPTION                             |
| 3      | ORDERING INFORMATION                            |
| 4      | BLOCK DIAGRAM                                   |
| 5      | PINNING INFORMATION                             |
| 5.1    | Pinning   |
| 5.2    | Pin description                                 |
| 6      | PARALLEL PORTS                                  |
| 7      | INSTRUCTION SET                                 |
| 8      | SUMMARY OF DERIVATIVE PORTS AND<br>REGISTERS    |
| 9      | ROM MASK OPTIONS                                |
| 10     | HANDLING  |
| 11     | LIMITING VALUES                                 |
| 12     | DC CHARACTERISTICS                              |
| 13     | AC CHARACTERISTICS                              |
| 13.1   | I <sup>2</sup> C-bus interface characteristics  |
| 14     | PACKAGE OUTLINES                                |
| 15     | SOLDERING                                       |
| 15.1   | Introduction                                    |
| 15.2   | DIP   |
| 15.2.1 | Soldering by dipping or by wave                 |
| 15.2.2 | Repairing soldered joints                       |
| 15.3   | SO and VSO                                      |
| 15.3.1 | Reflow soldering                                |
| 15.3.2 | Wave soldering                                  |
| 15.3.3 | Repairing soldered joints                       |
| 16     | DEFINITIONS                                     |
| 17     | LIFE SUPPORT APPLICATIONS                       |
| 18     | PURCHASE OF PHILIPS I <sup>2</sup> C COMPONENTS |



## Microcontroller with extended I/O

## PCF84C85A

**1 FEATURES**

- 8-bit CPU, ROM, RAM, I/O in a single 40-lead package
- 8 kbytes ROM
- 256 bytes RAM
- I<sup>2</sup>C-bus interface with multi-master capability
- Over 100 instructions (based on MAB8048) all of 1 or 2 cycles
- 32 quasi-bidirectional I/O port lines
- 8-bit programmable timer/event counter 1
- Three single-level vectored interrupts:
  - external
  - 8-bit programmable timer/event counter 1
  - I<sup>2</sup>C-bus
- Two test inputs, one of which also serves as the external interrupt input
- Stop and Idle modes
- Logic supply voltage:  $V_{DD} = 2.5$  to  $5.5$  V
- Clock frequency: 1 to 16 MHz
- Operating temperature:  $-40$  to  $+85$  °C
- Manufactured in silicon gate CMOS process.

**3 ORDERING INFORMATION** (see note 1)

| TYPE NUMBER | PACKAGE |  |           |
|-------------|---------|--|-----------|
|             | NAME    | DESCRIPTION                                      | VERSION   |
| PCF84C85AP  | DIP40   | plastic dual in-line package; 40 leads (600 mil) | SOT 129-1 |
| PCF84C85AT  | VSO40   | plastic very small outline package; 40 leads     | SOT 158-1 |

**Note**

1. Please refer to the Order Entry Form (OEF) for this device for the full type number to use when ordering. This type number will also specify the required program and the ROM mask options.

**2 GENERAL DESCRIPTION**

This data sheet details the specific properties of the PCF84C85A. The shared properties of the PCF84CxxxA family of microcontrollers are described in the "PCD84xxxA family" data sheet which should be read in conjunction with this publication.

The PCF84C85A is a general purpose CMOS microcontroller with emphasis on input/output. It provides 32 I/O port lines, 8 kbytes of program memory and 256 bytes of RAM. In addition to the 32 I/O port lines, the microcontroller provides an on-chip I<sup>2</sup>C-bus interface. This two-line serial bus extends the microcontroller's capabilities when implemented with the powerful I<sup>2</sup>C-bus peripherals. These include LCD drivers, telecom circuits, AD/DA converters, clock/calendar circuits, EEPROM and RAM and are listed in "Data Handbook IC12, I<sup>2</sup>C Peripherals".

The instruction set is based on that of the MAB8048 and is a sub-set of that listed in the "PCF84CXXXA family" data sheet.

# Microcontroller with extended I/O

# PCF84C85A

## 4 BLOCK DIAGRAM

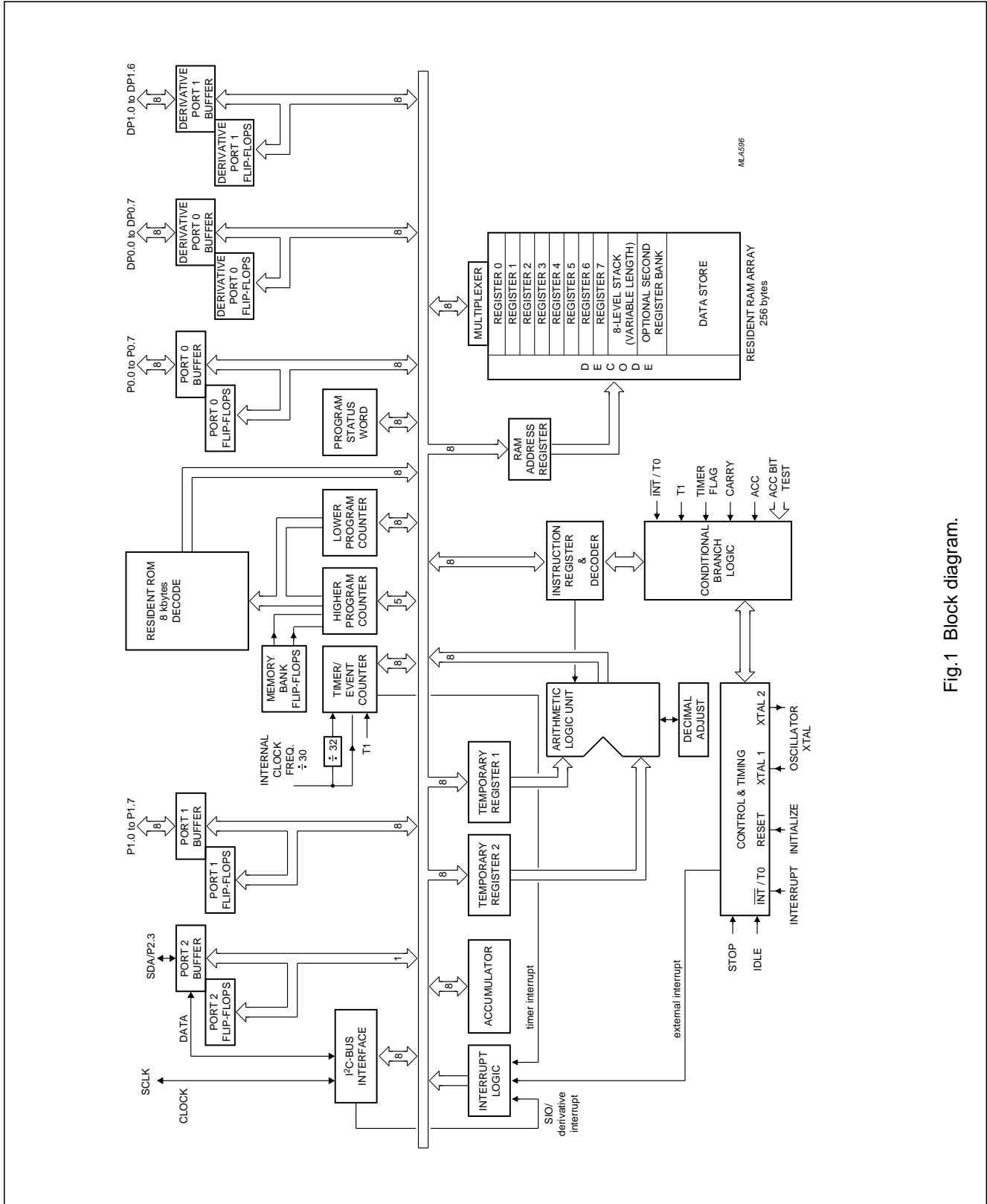

Fig.1 Block diagram.

Microcontroller with extended I/O

PCF84C85A

5 PINNING INFORMATION

5.1 Pinning

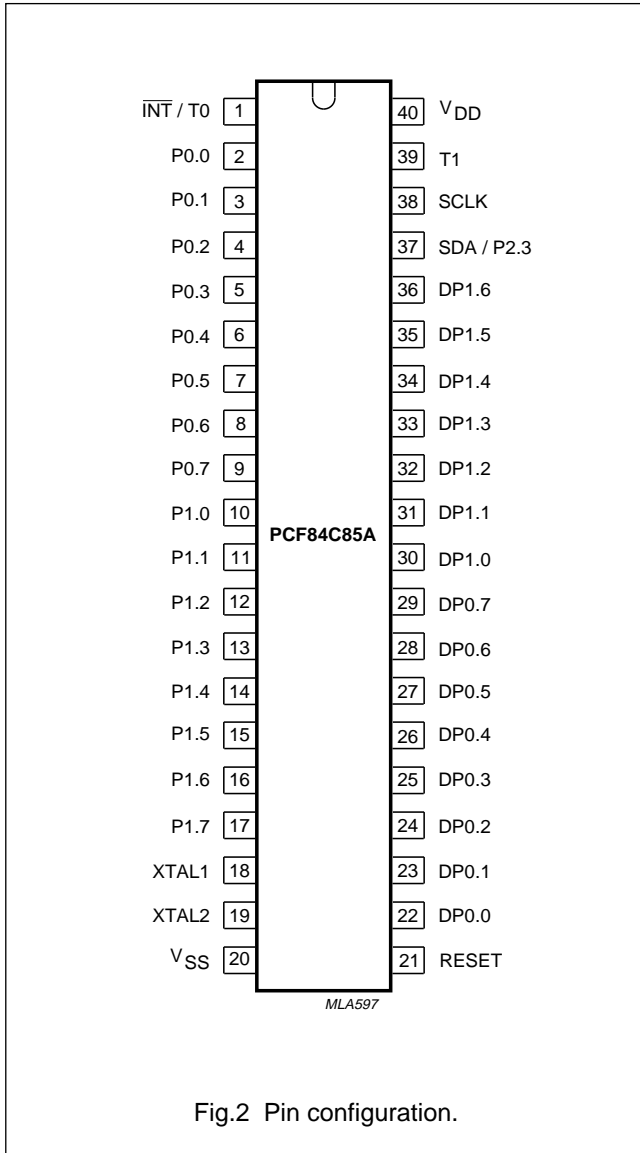

Fig.2 Pin configuration.

5.2 Pin description

Table 1 DIP40 and VSO40 packages.

| SYMBOL                            | PIN      | TYPE | DESCRIPTION  |
|-----------------------------------|----------|------|--|
| $\overline{\text{INT}}/\text{T0}$ | 1        | I    | Interrupt/Test 0   |
| P0.0 to P0.7                      | 2 to 9   | I/O  | 8 bits of Port 0: 8-bit quasi-bidirectional I/O port   |
| P1.0 to P1.7                      | 10 to 17 | I/O  | 8 bits of Port 1: 8-bit quasi-bidirectional I/O port   |
| XTAL1                             | 18       | I    | XTAL input: crystal oscillator/external clock input  |
| XTAL2                             | 19       | O    | XTAL output: crystal oscillator output   |
| $V_{SS}$                          | 20       | P    | ground   |
| RESET                             | 21       | I    | Reset input  |
| DP0.0 to DP0.7                    | 22 to 29 | I/O  | Derivative Port 0: quasi-bidirectional I/O port (8-bit)  |
| DP1.0 to DP1.6                    | 30 to 36 | I/O  | Derivative Port 1: quasi-bidirectional I/O lines (7-bit)   |
| SDA/P2.3                          | 37       | I/O  | bidirectional data line of the I <sup>2</sup> C-bus interface; or Port 2 quasi-bidirectional I/O port (1 bit only) |
| SCLK                              | 38       | I/O  | bidirectional clock line of the I <sup>2</sup> C-bus interface   |
| T1                                | 39       | I    | Test 1: count input of 8-bit timer/event counter 1   |
| $V_{DD}$                          | 40       | P    | positive supply  |

6 PARALLEL PORTS

Of the standard quasi-bidirectional I/O ports, Port 2 is incomplete, providing only line SDA/P2.3 that is shared with the I<sup>2</sup>C-bus interface. In addition to the standard ports, two derivative I/O ports are available:

- Derivative Port of 8 lines (DP0.0 to DP0.7)
- Derivative Port of 7 lines (DP1.0 to DP1.6).

Missing bits of incomplete ports, i.e. P2.0 to P2.2 and DP1.7, are fixed at zero in the corresponding registers.

7 INSTRUCTION SET

See "PCF84CXXXA family" data sheet for a complete description of the instruction set.

## Microcontroller with extended I/O

## PCF84C85A

## 8 SUMMARY OF DERIVATIVE PORTS AND REGISTERS

Table 2 Derivative Ports.

| DERIVATIVE ADDRESS | TYPE | REGISTER MNEMONIC | DESCRIPTION                  |
|--------------------|------|-------------------|------------------------------|
| 00H                | R    | DP0L              | Derivative Port 0 lines      |
| 01H                | R    | DP1L              | Derivative Port 1 lines      |
| 02H                | R/W  | DP0FF             | Derivative Port 0 flip-flops |
| 03H                | R/W  | DP1FF             | Derivative Port 1 flip-flops |
| 04H                | –    | –                 |                              |

Table 3 Derivative Registers.

| REGISTER MNEMONIC | 7    | 6    | 5    | 4    | 3    | 2    | 1    | 0    |
|-------------------|------|------|------|------|------|------|------|------|
| DP0L              | D0.7 | D0.6 | D0.5 | D0.4 | D0.3 | D0.2 | D0.1 | D0.0 |
| DP1L              | 0    | D1.6 | D1.5 | D1.4 | D1.3 | D1.2 | D1.1 | D1.0 |
| DP0FF             | F0.7 | F0.6 | F0.5 | F0.4 | F0.3 | F0.2 | F0.1 | F0.0 |
| DP1FF             | 0    | F1.6 | F1.5 | F1.4 | F1.3 | F1.2 | F1.1 | F1.0 |

## 9 ROM MASK OPTIONS

| ROM CODE                      | OPTION   |                           |                         |
|-------------------------------|--|---------------------------|-------------------------|
| <b>Program/data</b>           | Any mix of instructions and data up to ROM size of 8 kbytes. |                           |                         |
| <b>Port Output</b>            |  |                           |                         |
| P0.0 to P0.7                  | standard   | open-drain                | push-pull               |
| P1.0 to P1.7                  | standard   | open-drain                | push-pull               |
| SDA/P2.3                      | –  | open-drain                | –                       |
| DP0.0 to DP0.7                | standard   | open-drain                | push-pull               |
| DP1.0 to DP1.7                | standard   | open-drain                | push-pull               |
| <b>Port State after reset</b> |  |                           |                         |
| P0.0 to P0.7                  | set  | reset                     | –                       |
| P1.0 to P1.7                  | set  | reset                     | –                       |
| SDA/P2.3                      | set  | –                         | –                       |
| DP1.0 to DP1.7                | set  | reset                     | –                       |
| DP2.0 to DP2.2                | set  | reset                     | –                       |
| <b>Oscillator</b>             |  |                           |                         |
| Transconductance              | LOW (g <sub>mL</sub> )                                       | MEDIUM (g <sub>mM</sub> ) | HIGH (g <sub>mH</sub> ) |

## Microcontroller with extended I/O

## PCF84C85A

**10 HANDLING**

Inputs and outputs are protected against electrostatic discharge in normal handling. However, it is good practice to take normal precautions appropriate to handling MOS devices. See *"Data Handbook IC14, Section: Handling MOS devices"*.

**11 LIMITING VALUES**

In accordance with the Absolute Maximum Rating System (IEC 134).

| SYMBOL    | PARAMETER                          | MIN. | MAX.           | UNIT |
|-----------|------------------------------------|------|----------------|------|
| $V_{DD}$  | supply voltage                     | -0.5 | +7             | V    |
| $V_I$     | all input voltages                 | -0.5 | $V_{DD} + 0.5$ | V    |
| $I_I$     | DC input current                   | -10  | +10            | mA   |
| $I_O$     | DC output current                  | -10  | +10            | mA   |
| $P_{tot}$ | total power dissipation            | -    | 125            | mW   |
| $P_O$     | power dissipation per output       | -    | 30             | mW   |
| $I_{SS}$  | ground supply current ( $V_{SS}$ ) | -50  | +50            | mA   |
| $T_{stg}$ | storage temperature range          | -65  | +150           | °C   |
| $T_j$     | operating junction temperature     | -    | 90             | °C   |

## Microcontroller with extended I/O

## PCF84C85A

**12 DC CHARACTERISTICS**

$V_{DD} = 2.5$  to  $5.5$  V;  $V_{SS} = 0$  V;  $T_{amb} = -40$  to  $+85$  °C; all voltages with respect to  $V_{SS}$ ; unless otherwise specified.

| SYMBOL                         | PARAMETER   | CONDITIONS   | MIN.             | TYP.                     | MAX.                     | UNIT                 |
|--------------------------------|---|--|------------------|--------------------------|--------------------------|----------------------|
| $V_{DD}$                       | operating supply voltage                                | see Fig. 3   | 2.5              | –                        | 5.5                      | V                    |
| $I_{DD}$                       | operating supply current                                | note 1; see Figs 4 and 5<br>$V_{DD} = 3$ V; $f_{xtal} = 3.58$ MHz ( $g_{mL}$ )<br>$V_{DD} = 5$ V; $f_{xtal} = 10$ MHz ( $g_{mL}$ )<br>$V_{DD} = 5$ V; $f_{xtal} = 16$ MHz ( $g_{mM}$ )<br>$V_{DD} = 5$ V; $f_{xtal} = 16$ MHz ( $g_{mH}$ ) | –<br>–<br>–<br>– | 0.3<br>1.1<br>1.7<br>2.5 | 0.6<br>3.0<br>5.0<br>6.0 | mA<br>mA<br>mA<br>mA |
| $I_{DD(idle)}$                 | supply current (Idle mode)                              | note 1; see Figs 6 and 7<br>$V_{DD} = 3$ V; $f_{xtal} = 3.58$ MHz ( $g_{mL}$ )<br>$V_{DD} = 5$ V; $f_{xtal} = 10$ MHz ( $g_{mL}$ )<br>$V_{DD} = 5$ V; $f_{xtal} = 16$ MHz ( $g_{mM}$ )<br>$V_{DD} = 5$ V; $f_{xtal} = 16$ MHz ( $g_{mH}$ ) | –<br>–<br>–<br>– | 0.2<br>0.8<br>1.2<br>1.7 | 0.4<br>1.6<br>4.0<br>5.0 | mA<br>mA<br>mA<br>mA |
| $I_{DD(stp)}$                  | supply current (Stop mode)                              | $V_{DD} = 2.5$ V; notes 1 and 2; see Fig.8   | –                | 1.2                      | 10                       | µA                   |
| <b>Inputs</b>                  |   |  |                  |                          |                          |                      |
| $V_{IL}$                       | LOW level input voltage                                 |  | 0                | –                        | $0.3V_{DD}$              | V                    |
| $V_{IH}$                       | HIGH level input voltage                                |  | $0.7V_{DD}$      | –                        | $V_{DD}$                 | V                    |
| $I_{LI}$                       | input leakage current                                   | $V_{SS} \leq V_I \leq V_{DD}$  | –1               | –                        | +1                       | µA                   |
| <b>Outputs</b>                 |   |  |                  |                          |                          |                      |
| $I_{OL}$                       | LOW level output sink current; except SDA/P2.3 and SCLK | $V_{DD} = 5$ V; $V_O = 0.4$ V; see Fig.9   | 1.6              | 12                       | –                        | mA                   |
| $I_{OL2}$                      | LOW level output sink current; SDA/P2.3 and SCLK        | $V_{DD} = 5$ V; $V_O = 0.4$ V; see Fig.10  | 3.0              | 12                       | –                        | mA                   |
| $I_{OH}$                       | HIGH level pull-up output source current                | $V_{DD} = 5$ V; $V_O = 3.5$ V; see Fig.11  | –40              | –100                     | –                        | µA                   |
|                                |   | $V_{DD} = 5$ V; $V_O = 0$ V; see Fig.11  | –                | –140                     | –400                     | µA                   |
| $I_{OH1}$                      | HIGH level push-pull output source current              | $V_{DD} = 5$ V; $V_O = 4.6$ V; see Fig.12  | –1.6             | –7                       | –                        | mA                   |
| <b>Oscillator</b> (see Fig.13) |   |  |                  |                          |                          |                      |
| $g_{mL}$                       | LOW transconductance                                    | $V_{DD} = 5$ V   | 0.2              | 0.4                      | 1.0                      | mS                   |
| $g_{mM}$                       | MEDIUM transconductance                                 | $V_{DD} = 5$ V   | 0.9              | 1.6                      | 3.2                      | mS                   |
| $g_{mH}$                       | HIGH transconductance                                   | $V_{DD} = 5$ V   | 3.0              | 4.5                      | 9.0                      | mS                   |
| $R_F$                          | feedback resistor                                       |  | 0.3              | 1.0                      | 3.0                      | MΩ                   |

**Notes**

- $V_{IL} = V_{SS}$ ;  $V_{IH} = V_{DD}$ ; open drain outputs connected to  $V_{SS}$ ; all other outputs, including XTAL2, open (typical values at 25 °C with crystal connected between XTAL1 and XTAL2).
- $V_{IL} = V_{SS}$ ;  $V_{IH} = V_{DD}$ ; RESET and T1 at  $V_{SS}$ ;  $\overline{INT}/T0$  at  $V_{DD}$ ; crystal connected between XTAL1 and XTAL2; open drain outputs connected to  $V_{SS}$ ; all other outputs open.



Microcontroller with extended I/O

PCF84C85A

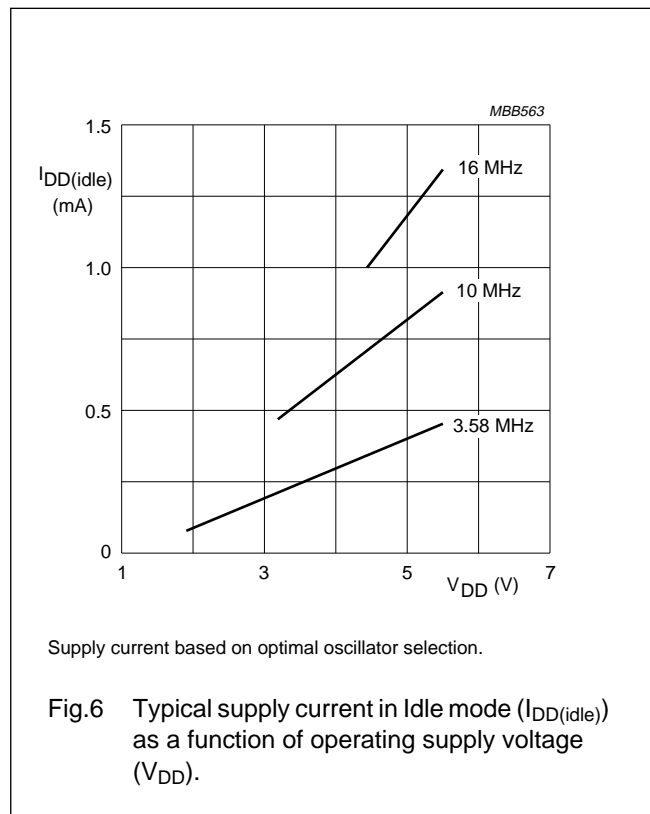
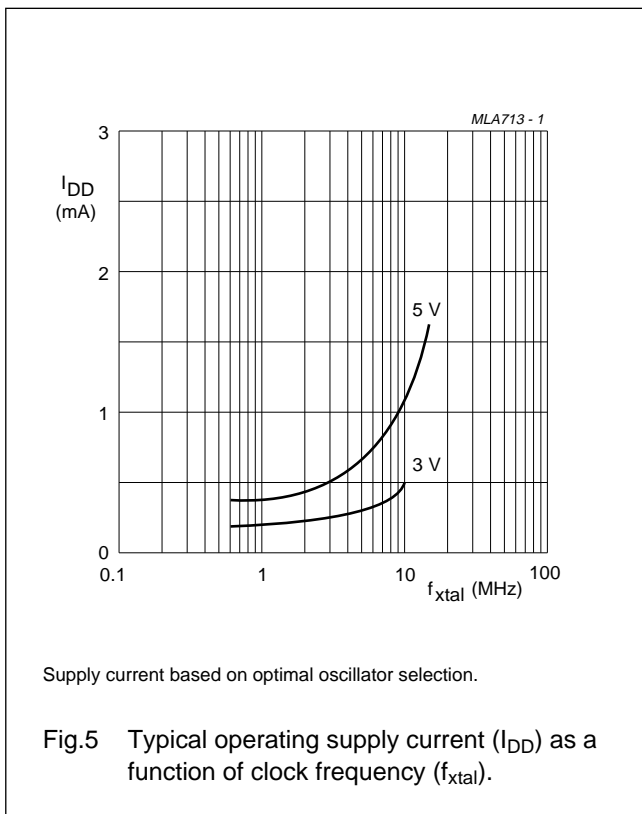
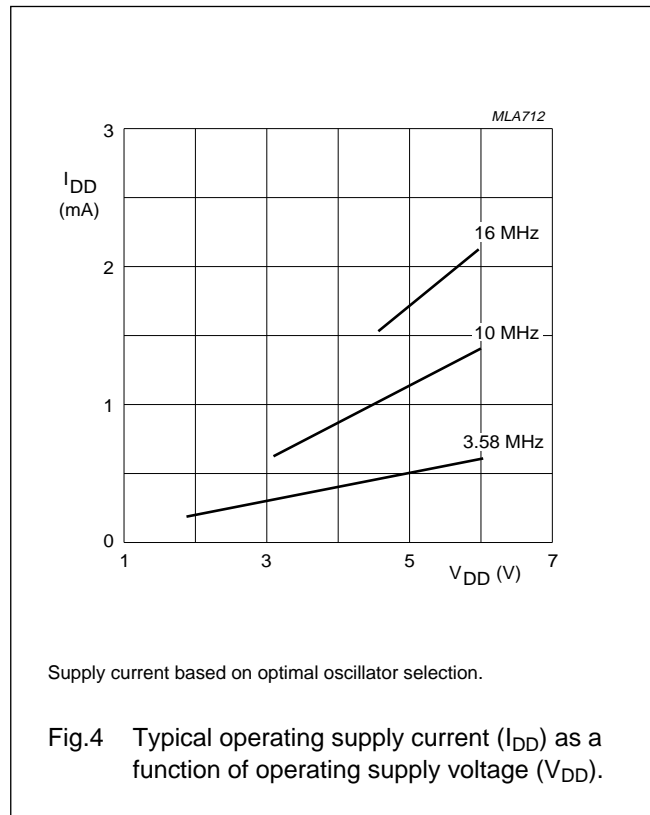
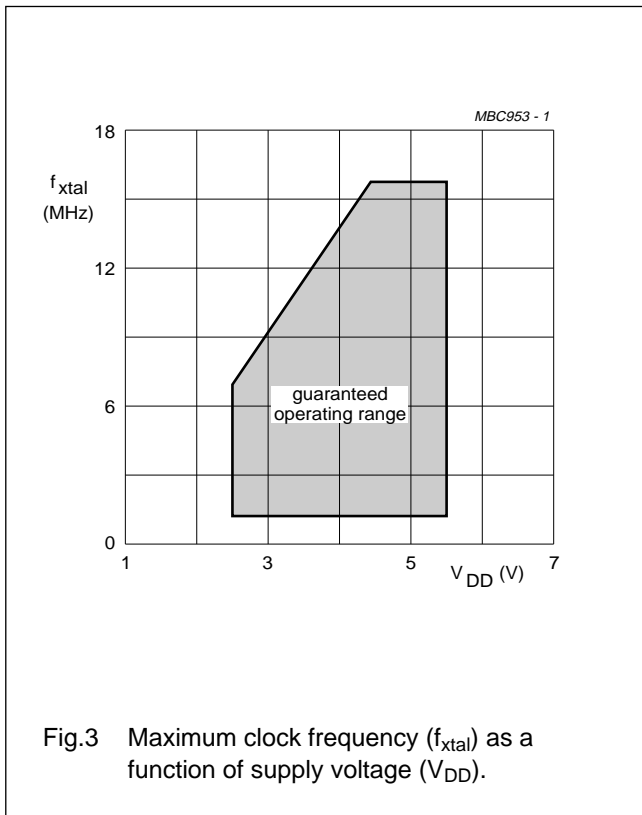

Microcontroller with extended I/O

PCF84C85A

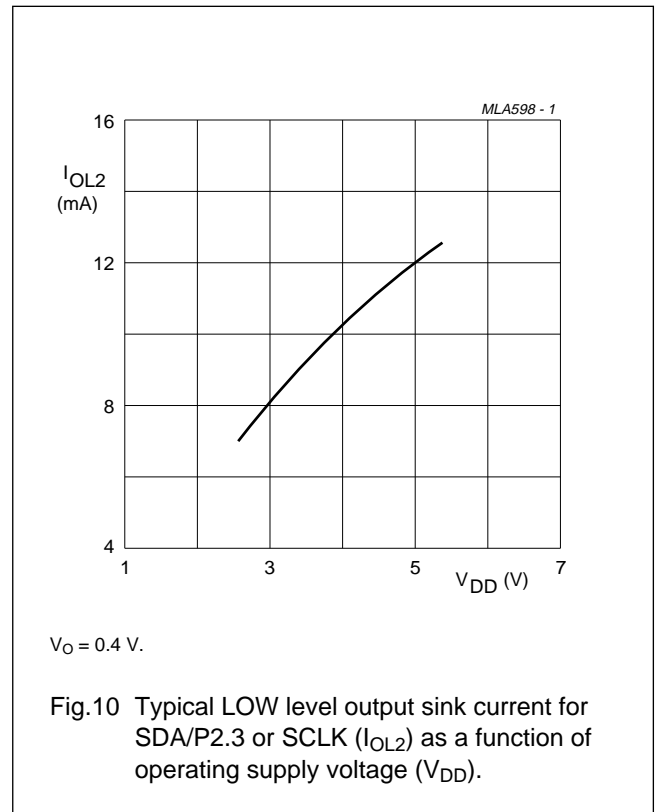
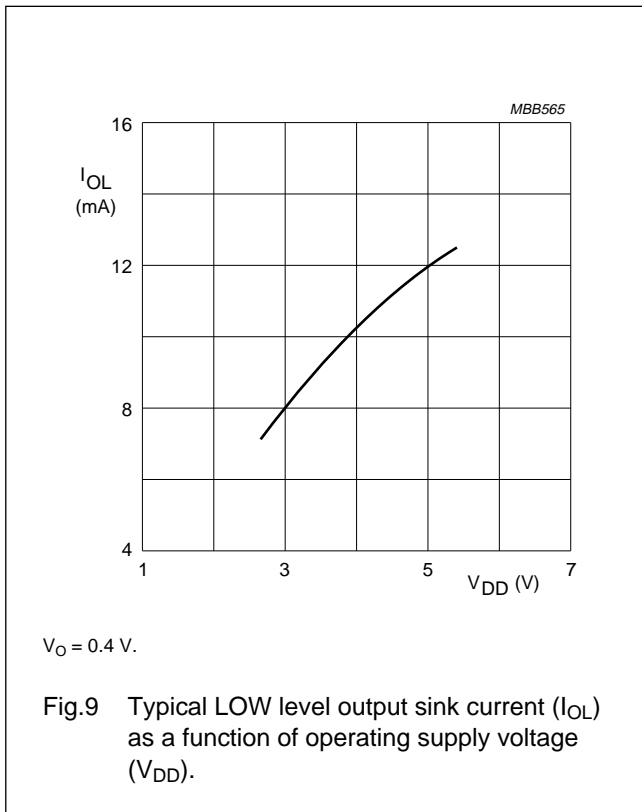
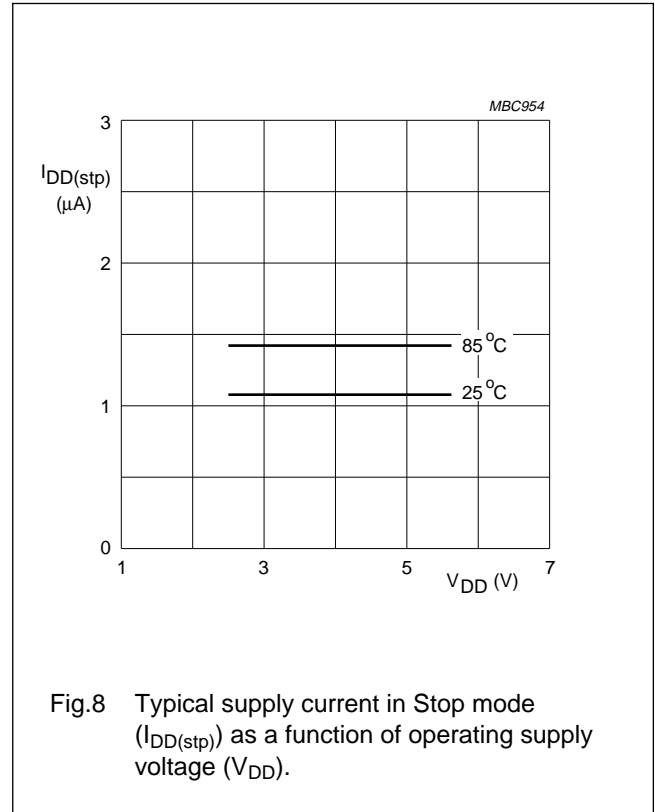
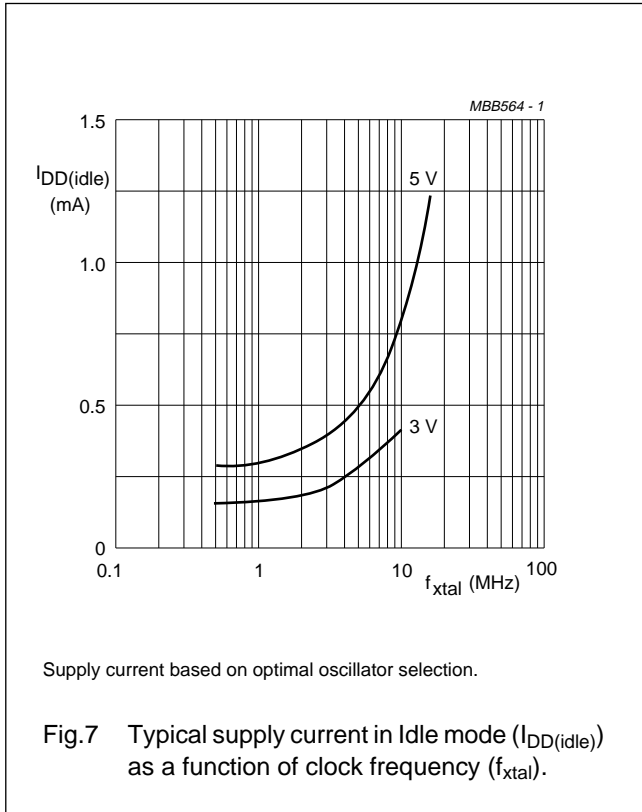

Microcontroller with extended I/O

PCF84C85A

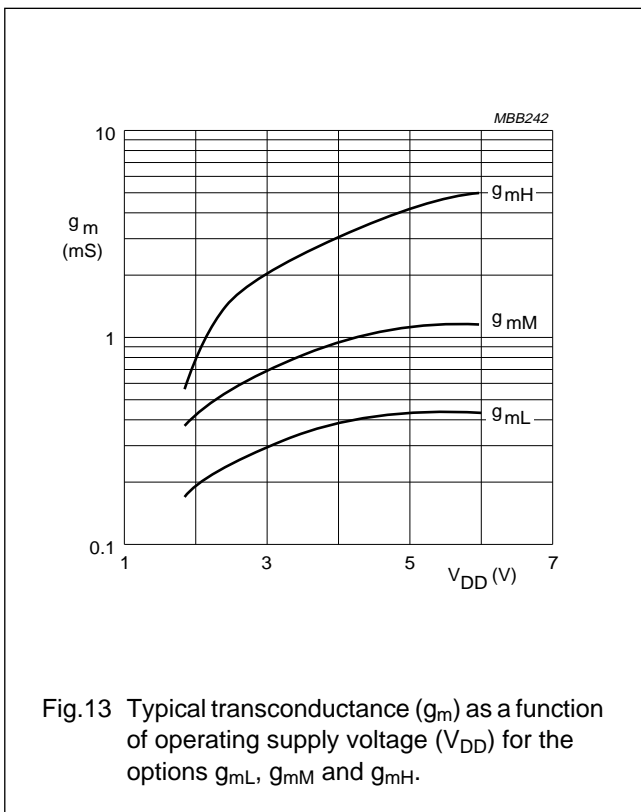
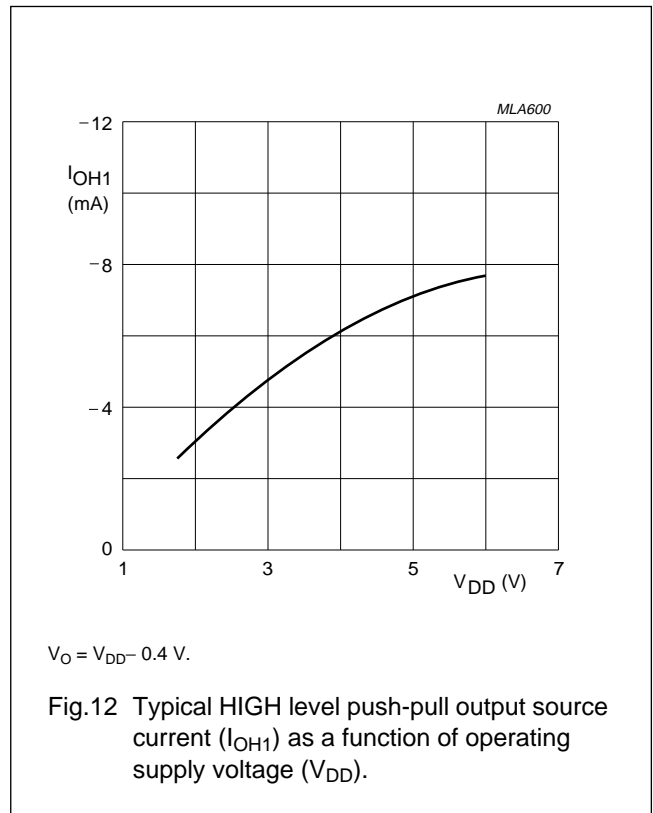
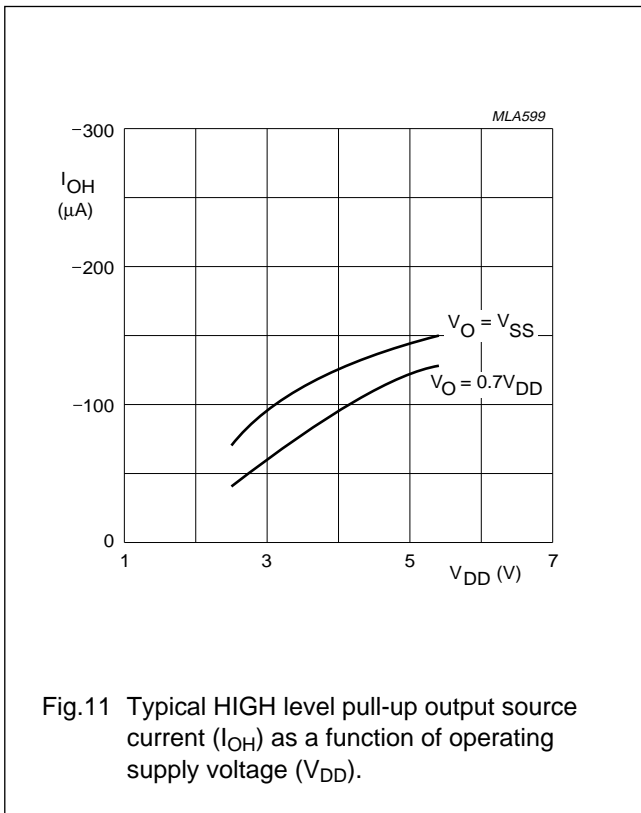

## Microcontroller with extended I/O

## PCF84C85A

**13 AC CHARACTERISTICS**

$V_{DD} = 2.5$  to  $5.5$  V;  $V_{SS} = 0$  V;  $T_{amb} = -40$  to  $+85$  °C; all voltages with respect to  $V_{SS}$ ; unless otherwise specified.

| SYMBOL     | PARAMETER             | CONDITIONS                                       | MIN. | TYP. | MAX. | UNIT |
|------------|-----------------------|--|------|------|------|------|
| $t_r$      | rise time all outputs | $V_{DD} = 5$ V; $T_{amb} = 25$ °C; $C_L = 50$ pF | –    | 30   | –    | ns   |
| $t_f$      | fall time all outputs | $V_{DD} = 5$ V; $T_{amb} = 25$ °C; $C_L = 50$ pF | –    | 30   | –    | ns   |
| $f_{xtal}$ | clock frequency       | see Fig.3  | 1    | –    | 16   | MHz  |

**Table 4** I<sup>2</sup>C-bus timing (see Figs 14 and 15)

| SYMBOL       | PARAMETER                  | INPUT<br>(see Fig.14)      | OUTPUT<br>(see Fig.15; note 1)              |
|--------------|----------------------------|----------------------------|---|
| <b>SCLK</b>  |                            |                            |   |
| $t_{HD;STA}$ | START condition hold time  | $\geq \frac{14}{f_{xtal}}$ | $\frac{DF + 9}{2 \times f_{xtal}}$          |
| $t_{LOW}$    | SCLK LOW time              | $\geq \frac{17}{f_{xtal}}$ | $\frac{DF - 3}{2 \times f_{xtal}}$ ; note 2 |
| $t_{HIGH}$   | SCLK HIGH time             | $\geq \frac{17}{f_{xtal}}$ | $\frac{DF + 3}{2 \times f_{xtal}}$ ; note 2 |
| $t_{RC}$     | SCLK rise time             | $\leq 1$ $\mu$ s           | $\leq 1$ $\mu$ s; note 3                    |
| $t_{FC}$     | SCLK fall time             | $\leq 0.3$ $\mu$ s         | $\leq 0.1$ $\mu$ s; note 4                  |
| <b>SDA</b>   |                            |                            |   |
| $t_{BUF}$    | bus free time              | $\geq \frac{14}{f_{xtal}}$ | $\geq 4.7$ $\mu$ s; note 5                  |
| $t_{SU;DAT}$ | data set-up time           | $\geq 250$ ns              | $\geq \frac{15}{f_{xtal}}$ ; note 6         |
| $t_{HD;DAT}$ | data hold time             | $\geq 0$                   | $\geq \frac{9}{f_{xtal}}$                   |
| $t_{RD}$     | SDA/P2.3 rise time         | $\leq 1$ $\mu$ s           | $\leq 1$ $\mu$ s; note 3                    |
| $t_{FD}$     | SDA/P2.3 fall time         | $\leq 0.3$ $\mu$ s         | $\leq 0.1$ $\mu$ s; note 4                  |
| $t_{SU;STO}$ | STOP condition set-up time | $\geq \frac{14}{f_{xtal}}$ | $\frac{DF - 3}{2 \times f_{xtal}}$          |

**Notes**

1. DF stands for Division Factor: the divisor of  $f_{xtal}$  (see "PCF84CXXXA family" data sheet).

2. Values given for ASC = 0; for ASC = 1:  $t_{HIGH} = \frac{3(DF + 1)}{4 \times f_{xtal}}$ ;  $t_{LOW} = \frac{DF - 3}{4 \times f_{xtal}}$

3. Determined by I<sup>2</sup>C-bus capacitance ( $C_b$ ) and external pull-up resistor.

4. At maximum allowed I<sup>2</sup>C-bus capacitance  $C_b = 400$  pF.

5. Determined by program.

6. If  $t_{LOW} < \frac{24}{f_{xtal}}$ ,  $t_{SU;DAT} \geq \frac{t_{LOW} - 9}{f_{xtal}}$ , independent of ASC.

Microcontroller with extended I/O

PCF84C85A

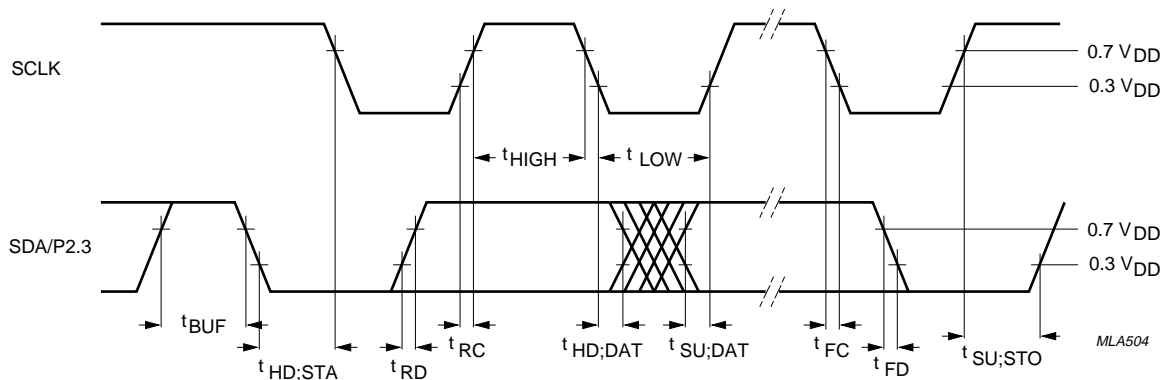

Fig.14 Slave SCLK and receiver SDA/P2.3 timing (SCLK and SDA/P2.3 are inputs).

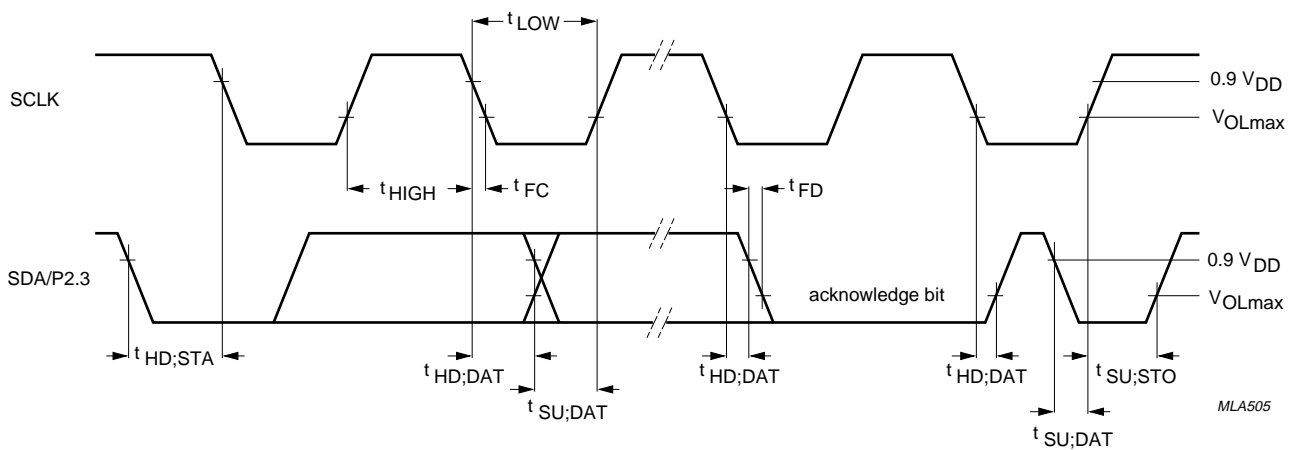

Fig.15 Master SCLK and transmitter SDA/P2.3 timing (SCLK and SDA/P2.3 are outputs).

Microcontroller with extended I/O

PCF84C85A

14 PACKAGE OUTLINES

VSO40: plastic very small outline package; 40 leads

SOT158-1

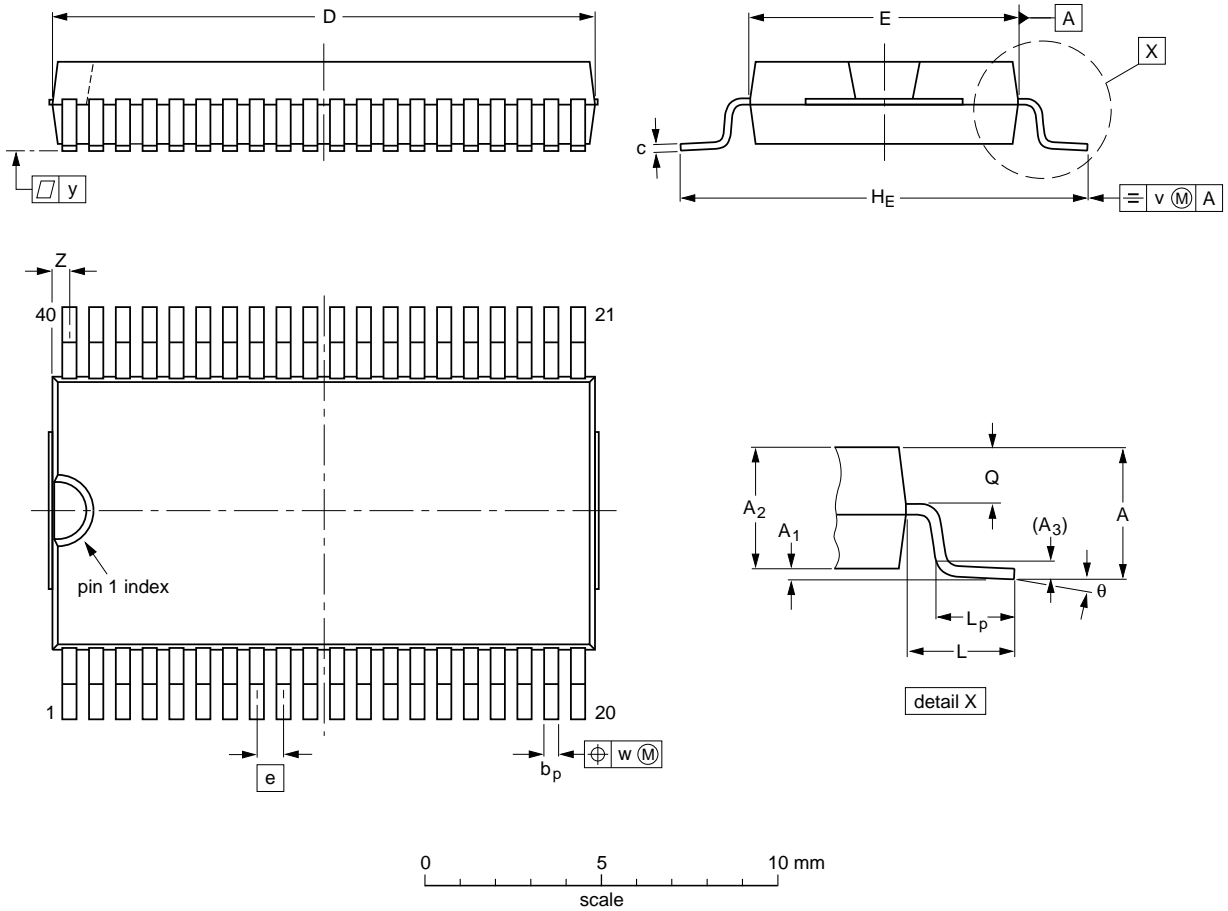

DIMENSIONS (inch dimensions are derived from the original mm dimensions)

| UNIT   | A max. | A <sub>1</sub> | A <sub>2</sub> | A <sub>3</sub> | b <sub>p</sub> | c                | D <sup>(1)</sup> | E <sup>(2)</sup> | e     | H <sub>E</sub> | L     | L <sub>p</sub> | Q              | v     | w     | y     | Z <sup>(1)</sup> | θ  |
|--------|--------|----------------|----------------|----------------|----------------|------------------|------------------|------------------|-------|----------------|-------|----------------|----------------|-------|-------|-------|------------------|----|
| mm     | 2.70   | 0.3<br>0.1     | 2.45<br>2.25   | 0.25           | 0.42<br>0.30   | 0.22<br>0.14     | 15.6<br>15.2     | 7.6<br>7.5       | 0.762 | 12.3<br>11.8   | 2.25  | 1.7<br>1.5     | 1.15<br>1.05   | 0.2   | 0.1   | 0.1   | 0.6<br>0.3       | 7° |
| inches | 0.11   | 0.012<br>0.004 | 0.096<br>0.089 | 0.010          | 0.017<br>0.012 | 0.0087<br>0.0055 | 0.61<br>0.60     | 0.30<br>0.29     | 0.03  | 0.48<br>0.46   | 0.089 | 0.067<br>0.059 | 0.045<br>0.041 | 0.008 | 0.004 | 0.004 | 0.024<br>0.012   | 0° |

Notes

1. Plastic or metal protrusions of 0.4 mm maximum per side are not included.
2. Plastic interlead protrusions of 0.25 mm maximum per side are not included.

| OUTLINE VERSION | REFERENCES |       |      |  | EUROPEAN PROJECTION | ISSUE DATE           |
|-----------------|------------|-------|------|--|---------------------|----------------------|
|                 | IEC        | JEDEC | EIAJ |  |                     |                      |
| SOT158-1        |            |       |      |  |                     | 92-11-17<br>95-01-24 |

Microcontroller with extended I/O

PCF84C85A

DIP40: plastic dual in-line package; 40 leads (600 mil)

SOT129-1

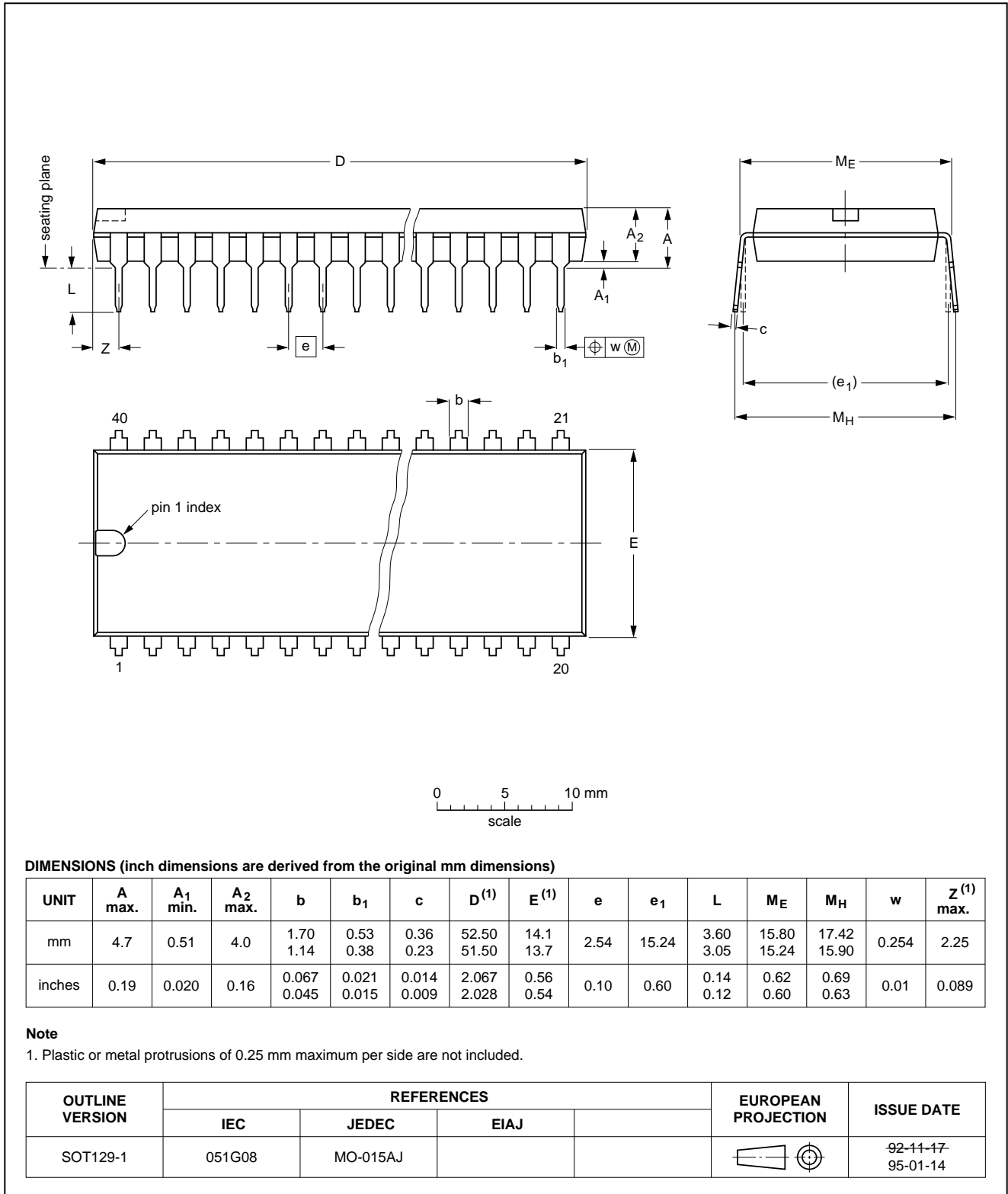

## Microcontroller with extended I/O

## PCF84C85A

### 15 SOLDERING

#### 15.1 Introduction

There is no soldering method that is ideal for all IC packages. Wave soldering is often preferred when through-hole and surface mounted components are mixed on one printed-circuit board. However, wave soldering is not always suitable for surface mounted ICs, or for printed-circuits with high population densities. In these situations reflow soldering is often used.

This text gives a very brief insight to a complex technology. A more in-depth account of soldering ICs can be found in our "IC Package Databook" (order code 9398 652 90011).

#### 15.2 DIP

##### 15.2.1 SOLDERING BY DIPPING OR BY WAVE

The maximum permissible temperature of the solder is 260 °C; solder at this temperature must not be in contact with the joint for more than 5 seconds. The total contact time of successive solder waves must not exceed 5 seconds.

The device may be mounted up to the seating plane, but the temperature of the plastic body must not exceed the specified maximum storage temperature ( $T_{stg\ max}$ ). If the printed-circuit board has been pre-heated, forced cooling may be necessary immediately after soldering to keep the temperature within the permissible limit.

##### 15.2.2 REPAIRING SOLDERED JOINTS

Apply a low voltage soldering iron (less than 24 V) to the lead(s) of the package, below the seating plane or not more than 2 mm above it. If the temperature of the soldering iron bit is less than 300 °C it may remain in contact for up to 10 seconds. If the bit temperature is between 300 and 400 °C, contact may be up to 5 seconds.

#### 15.3 SO and VSO

##### 15.3.1 REFLOW SOLDERING

Reflow soldering techniques are suitable for all SO and VSO packages.

Reflow soldering requires solder paste (a suspension of fine solder particles, flux and binding agent) to be applied to the printed-circuit board by screen printing, stencilling or pressure-syringe dispensing before package placement.

Several techniques exist for reflowing; for example, thermal conduction by heated belt. Dwell times vary between 50 and 300 seconds depending on heating method. Typical reflow temperatures range from 215 to 250 °C.

Preheating is necessary to dry the paste and evaporate the binding agent. Preheating duration: 45 minutes at 45 °C.

##### 15.3.2 WAVE SOLDERING

Wave soldering techniques can be used for all SO and VSO packages if the following conditions are observed:

- A double-wave (a turbulent wave with high upward pressure followed by a smooth laminar wave) soldering technique should be used.
- The longitudinal axis of the package footprint must be parallel to the solder flow.
- The package footprint must incorporate solder thieves at the downstream end.

During placement and before soldering, the package must be fixed with a droplet of adhesive. The adhesive can be applied by screen printing, pin transfer or syringe dispensing. The package can be soldered after the adhesive is cured.

Maximum permissible solder temperature is 260 °C, and maximum duration of package immersion in solder is 10 seconds, if cooled to less than 150 °C within 6 seconds. Typical dwell time is 4 seconds at 250 °C.

A mildly-activated flux will eliminate the need for removal of corrosive residues in most applications.

##### 15.3.3 REPAIRING SOLDERED JOINTS

Fix the component by first soldering two diagonally-opposite end leads. Use only a low voltage soldering iron (less than 24 V) applied to the flat part of the lead. Contact time must be limited to 10 seconds at up to 300 °C. When using a dedicated tool, all other leads can be soldered in one operation within 2 to 5 seconds between 270 and 320 °C.



## Microcontroller with extended I/O

## PCF84C85A

**16 DEFINITIONS**

|   |   |
|---|---|
| <b>Data sheet status</b>  |   |
| Objective specification   | This data sheet contains target or goal specifications for product development.       |
| Preliminary specification   | This data sheet contains preliminary data; supplementary data may be published later. |
| Product specification   | This data sheet contains final product specifications.                                |
| <b>Limiting values</b>  |   |
| Limiting values given are in accordance with the Absolute Maximum Rating System (IEC 134). Stress above one or more of the limiting values may cause permanent damage to the device. These are stress ratings only and operation of the device at these or at any other conditions above those given in the Characteristics sections of the specification is not implied. Exposure to limiting values for extended periods may affect device reliability. |   |
| <b>Application information</b>  |   |
| Where application information is given, it is advisory and does not form part of the specification.   |   |

**17 LIFE SUPPORT APPLICATIONS**

These products are not designed for use in life support appliances, devices, or systems where malfunction of these products can reasonably be expected to result in personal injury. Philips customers using or selling these products for use in such applications do so at their own risk and agree to fully indemnify Philips for any damages resulting from such improper use or sale.

**18 PURCHASE OF PHILIPS I<sup>2</sup>C COMPONENTS**

Purchase of Philips I<sup>2</sup>C components conveys a license under the Philips' I<sup>2</sup>C patent to use the components in the I<sup>2</sup>C system provided the system conforms to the I<sup>2</sup>C specification defined by Philips. This specification can be ordered using the code 9398 393 40011.

Microcontroller with extended I/O

PCF84C85A

---

**NOTES**

Microcontroller with extended I/O

PCF84C85A

---

**NOTES**

# Philips Semiconductors – a worldwide company

**Argentina:** see South America

**Australia:** 34 Waterloo Road, NORTH RYDE, NSW 2113,  
Tel. +61 2 9805 4455, Fax. +61 2 9805 4466

**Austria:** Computerstr. 6, A-1101 WIEN, P.O. Box 213,  
Tel. +43 1 60 101, Fax. +43 1 60 101 1210

**Belarus:** Hotel Minsk Business Center, Bld. 3, r. 1211, Volodarski Str. 6,  
220050 MINSK, Tel. +375 172 200 733, Fax. +375 172 200 773

**Belgium:** see The Netherlands

**Brazil:** see South America

**Bulgaria:** Philips Bulgaria Ltd., Energoproject, 15th floor,  
51 James Bourchier Blvd., 1407 SOFIA,  
Tel. +359 2 689 211, Fax. +359 2 689 102

**Canada:** PHILIPS SEMICONDUCTORS/COMPONENTS,  
Tel. +1 800 234 7381

**China/Hong Kong:** 501 Hong Kong Industrial Technology Centre,  
72 Tat Chee Avenue, Kowloon Tong, HONG KONG,  
Tel. +852 2319 7888, Fax. +852 2319 7700

**Colombia:** see South America

**Czech Republic:** see Austria

**Denmark:** Prags Boulevard 80, PB 1919, DK-2300 COPENHAGEN S,  
Tel. +45 32 88 2636, Fax. +45 31 57 1949

**Finland:** Sinikalliontie 3, FIN-02630 ESPOO,  
Tel. +358 9 615800, Fax. +358 9 61580/xxx

**France:** 4 Rue du Port-aux-Vins, BP317, 92156 SURESNES Cedex,  
Tel. +33 1 40 99 6161, Fax. +33 1 40 99 6427

**Germany:** Hammerbrookstraße 69, D-20097 HAMBURG,  
Tel. +49 40 23 53 60, Fax. +49 40 23 536 300

**Greece:** No. 15, 25th March Street, GR 17778 TAVROS/ATHENS,  
Tel. +30 1 4894 339/239, Fax. +30 1 4814 240

**Hungary:** see Austria

**India:** Philips INDIA Ltd, Shivsagar Estate, A Block, Dr. Annie Besant Rd.  
Worli, MUMBAI 400 018, Tel. +91 22 4938 541, Fax. +91 22 4938 722

**Indonesia:** see Singapore

**Ireland:** Newstead, Clonskeagh, DUBLIN 14,  
Tel. +353 1 7640 000, Fax. +353 1 7640 200

**Israel:** RAPAC Electronics, 7 Kehilat Saloniki St, TEL AVIV 61180,  
Tel. +972 3 645 0444, Fax. +972 3 649 1007

**Italy:** PHILIPS SEMICONDUCTORS, Piazza IV Novembre 3,  
20124 MILANO, Tel. +39 2 6752 2531, Fax. +39 2 6752 2557

**Japan:** Philips Bldg 13-37, Kohnan 2-chome, Minato-ku, TOKYO 108,  
Tel. +81 3 3740 5130, Fax. +81 3 3740 5077

**Korea:** Philips House, 260-199 Itaewon-dong, Yongsan-ku, SEOUL,  
Tel. +82 2 709 1412, Fax. +82 2 709 1415

**Malaysia:** No. 76 Jalan Universiti, 46200 PETALING JAYA, SELANGOR,  
Tel. +60 3 750 5214, Fax. +60 3 757 4880

**Mexico:** 5900 Gateway East, Suite 200, EL PASO, TEXAS 79905,  
Tel. +9-5 800 234 7381

**Middle East:** see Italy

**Netherlands:** Postbus 90050, 5600 PB EINDHOVEN, Bldg. VB,  
Tel. +31 40 27 82785, Fax. +31 40 27 88399

**New Zealand:** 2 Wagener Place, C.P.O. Box 1041, AUCKLAND,  
Tel. +64 9 849 4160, Fax. +64 9 849 7811

**Norway:** Box 1, Manglerud 0612, OSLO,  
Tel. +47 22 74 8000, Fax. +47 22 74 8341

**Philippines:** Philips Semiconductors Philippines Inc.,  
106 Valero St. Salcedo Village, P.O. Box 2108 MCC, MAKATI,  
Metro MANILA, Tel. +63 2 816 6380, Fax. +63 2 817 3474

**Poland:** Ul. Lukiska 10, PL 04-123 WARSZAWA,  
Tel. +48 22 612 2831, Fax. +48 22 612 2327

**Portugal:** see Spain

**Romania:** see Italy

**Russia:** Philips Russia, Ul. Usatcheva 35A, 119048 MOSCOW,  
Tel. +7 095 247 9145, Fax. +7 095 247 9144

**Singapore:** Lorong 1, Toa Payoh, SINGAPORE 1231,  
Tel. +65 350 2538, Fax. +65 251 6500

**Slovakia:** see Austria

**Slovenia:** see Italy

**South Africa:** S.A. PHILIPS Pty Ltd., 195-215 Main Road Martindale,  
2092 JOHANNESBURG, P.O. Box 7430 Johannesburg 2000,  
Tel. +27 11 470 5911, Fax. +27 11 470 5494

**South America:** Rua do Rocio 220, 5th floor, Suite 51,  
04552-903 São Paulo, SÃO PAULO - SP, Brazil,  
Tel. +55 11 821 2333, Fax. +55 11 829 1849

**Spain:** Balmes 22, 08007 BARCELONA,  
Tel. +34 3 301 6312, Fax. +34 3 301 4107

**Sweden:** Kottbygatan 7, Akalla, S-16485 STOCKHOLM,  
Tel. +46 8 632 2000, Fax. +46 8 632 2745

**Switzerland:** Allmendstrasse 140, CH-8027 ZÜRICH,  
Tel. +41 1 488 2686, Fax. +41 1 481 7730

**Taiwan:** PHILIPS TAIWAN Ltd., 23-30F, 66,  
Chung Hsiao West Road, Sec. 1, P.O. Box 22978,  
TAIPEI 100, Tel. +886 2 382 4443, Fax. +886 2 382 4444

**Thailand:** PHILIPS ELECTRONICS (THAILAND) Ltd.,  
209/2 Sanpavuth-Bangna Road Prakanong, BANGKOK 10260,  
Tel. +66 2 745 4090, Fax. +66 2 398 0793

**Turkey:** Talatpasa Cad. No. 5, 80640 GÜLTEPE/ISTANBUL,  
Tel. +90 212 279 2770, Fax. +90 212 282 6707

**Ukraine:** PHILIPS UKRAINE, 4 Patrice Lumumba str., Building B, Floor 7,  
252042 KIEV, Tel. +380 44 264 2776, Fax. +380 44 268 0461

**United Kingdom:** Philips Semiconductors Ltd., 276 Bath Road, Hayes,  
MIDDLESEX UB3 5BX, Tel. +44 181 730 5000, Fax. +44 181 754 8421

**United States:** 811 East Arques Avenue, SUNNYVALE, CA 94088-3409,  
Tel. +1 800 234 7381

**Uruguay:** see South America

**Vietnam:** see Singapore

**Yugoslavia:** PHILIPS, Trg N. Pasica 5/v, 11000 BEOGRAD,  
Tel. +381 11 625 344, Fax. +381 11 635 777

**For all other countries apply to:** Philips Semiconductors, Marketing & Sales Communications,  
Building BE-p, P.O. Box 218, 5600 MD EINDHOVEN, The Netherlands, Fax. +31 40 27 24825

**Internet:** <http://www.semiconductors.philips.com>

© Philips Electronics N.V. 1996

SCA52

All rights are reserved. Reproduction in whole or in part is prohibited without the prior written consent of the copyright owner.

The information presented in this document does not form part of any quotation or contract, is believed to be accurate and reliable and may be changed without notice. No liability will be accepted by the publisher for any consequence of its use. Publication thereof does not convey nor imply any license under patent- or other industrial or intellectual property rights.

Printed in The Netherlands

457021/1200/03/pp20

Date of release: 1996 Nov 21

Document order number: 9397 750 01084

*Let's make things better.*

**Philips  
Semiconductors**



**PHILIPS**