

Plastic Medium-Power Complementary Silicon Transistors

... designed for general-purpose amplifier and low-speed switching applications.

- High DC Current Gain —
 $h_{FE} = 2500$ (Typ) @ $I_C = 4.0$ Adc
- Collector-Emitter Sustaining Voltage — @ 100 mAdc
 $V_{CEO(sus)} = 60$ Vdc (Min) — TIP120, TIP125
 $= 80$ Vdc (Min) — TIP121, TIP126
 $= 100$ Vdc (Min) — TIP122, TIP127
- Low Collector-Emitter Saturation Voltage —
 $V_{CE(sat)} = 2.0$ Vdc (Max) @ $I_C = 3.0$ Adc
 $= 4.0$ Vdc (Max) @ $I_C = 5.0$ Adc
- Monolithic Construction with Built-In Base-Emitter Shunt Resistors
- TO-220AB Compact Package

***MAXIMUM RATINGS**

| Rating | Symbol | TIP120, TIP125 | TIP121, TIP126 | TIP122, TIP127 | Unit |
|---|----------------|-------------------|-------------------|-------------------|------------------------------|
| Collector-Emitter Voltage | V_{CEO} | 60 | 80 | 100 | Vdc |
| Collector-Base Voltage | V_{CB} | 60 | 80 | 100 | Vdc |
| Emitter-Base Voltage | V_{EB} | 5.0 | | | Vdc |
| Collector Current — Continuous Peak | I_C | 5.0 8.0 | | | Adc |
| Base Current | I_B | 120 | | | mAdc |
| Total Power Dissipation @ $T_C = 25^\circ\text{C}$ Derate above 25°C | P_D | 65 0.52 | | | Watts W/ $^\circ\text{C}$ |
| Total Power Dissipation @ $T_A = 25^\circ\text{C}$ Derate above 25°C | P_D | 2.0 0.016 | | | Watts W/ $^\circ\text{C}$ |
| Unclamped Inductive Load Energy (1) | E | 50 | | | mJ |
| Operating and Storage Junction, Temperature Range | T_J, T_{stg} | -65 to +150 | | | $^\circ\text{C}$ |

THERMAL CHARACTERISTICS

| Characteristic | Symbol | Max | Unit |
|---|-----------------|------|--------------------|
| Thermal Resistance, Junction to Case | $R_{\theta JC}$ | 1.92 | $^\circ\text{C/W}$ |
| Thermal Resistance, Junction to Ambient | $R_{\theta JA}$ | 62.5 | $^\circ\text{C/W}$ |

(1) $I_C = 1$ A, $L = 100$ mH, P.R.F. = 10 Hz, $V_{CC} = 20$ V, $R_{BE} = 100 \Omega$.

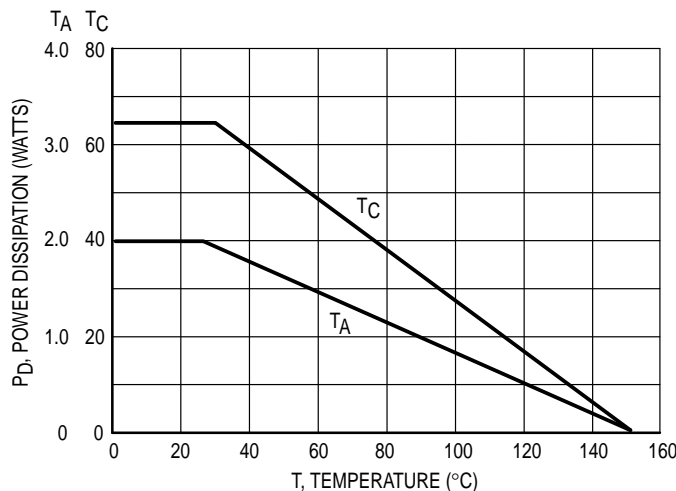

Figure 1. Power Derating

Preferred devices are Motorola recommended choices for future use and best overall value.

REV 2

NPN
TIP120*
TIP121*
TIP122*
PNP
TIP125*
TIP126*
TIP127*

*Motorola Preferred Device

DARLINGTON
5 AMPERE
COMPLEMENTARY SILICON
POWER TRANSISTORS
60-80-100 VOLTS
65 WATTS

CASE 221A-06
TO-220AB

TIP120 TIP121 TIP122 TIP125 TIP126 TIP127

ELECTRICAL CHARACTERISTICS ($T_C = 25^\circ\text{C}$ unless otherwise noted)

| Characteristic | Symbol | Min | Max | Unit |
|---|----------------|-----------------|-------------------|------|
| OFF CHARACTERISTICS | | | | |
| Collector–Emitter Sustaining Voltage (1) ($I_C = 100\text{ mAdc}$, $I_B = 0$) | $V_{CEO(sus)}$ | 60 80 100 | — | Vdc |
| Collector Cutoff Current ($V_{CE} = 30\text{ Vdc}$, $I_B = 0$) ($V_{CE} = 40\text{ Vdc}$, $I_B = 0$) ($V_{CE} = 50\text{ Vdc}$, $I_B = 0$) | I_{CEO} | — — — | 0.5 0.5 0.5 | mAdc |
| Collector Cutoff Current ($V_{CB} = 60\text{ Vdc}$, $I_E = 0$) ($V_{CB} = 80\text{ Vdc}$, $I_E = 0$) ($V_{CB} = 100\text{ Vdc}$, $I_E = 0$) | I_{CBO} | — — — | 0.2 0.2 0.2 | mAdc |
| Emitter Cutoff Current ($V_{BE} = 5.0\text{ Vdc}$, $I_C = 0$) | I_{EBO} | — | 2.0 | mAdc |

ON CHARACTERISTICS (1)

| | | | | |
|--|---------------|--------------|------------|-----|
| DC Current Gain ($I_C = 0.5\text{ Adc}$, $V_{CE} = 3.0\text{ Vdc}$) ($I_C = 3.0\text{ Adc}$, $V_{CE} = 3.0\text{ Vdc}$) | h_{FE} | 1000 1000 | — — | — |
| Collector–Emitter Saturation Voltage ($I_C = 3.0\text{ Adc}$, $I_B = 12\text{ mAdc}$) ($I_C = 5.0\text{ Adc}$, $I_B = 20\text{ mAdc}$) | $V_{CE(sat)}$ | — — | 2.0 4.0 | Vdc |
| Base–Emitter On Voltage ($I_C = 3.0\text{ Adc}$, $V_{CE} = 3.0\text{ Vdc}$) | $V_{BE(on)}$ | — | 2.5 | Vdc |

DYNAMIC CHARACTERISTICS

| | | | | |
|--|----------|--------|------------|----|
| Small–Signal Current Gain ($I_C = 3.0\text{ Adc}$, $V_{CE} = 4.0\text{ Vdc}$, $f = 1.0\text{ MHz}$) | h_{fe} | 4.0 | — | — |
| Output Capacitance ($V_{CB} = 10\text{ Vdc}$, $I_E = 0$, $f = 0.1\text{ MHz}$) | C_{ob} | — — | 300 200 | pF |

(1) Pulse Test: Pulse Width $\leq 300\ \mu\text{s}$, Duty Cycle $\leq 2\%$.

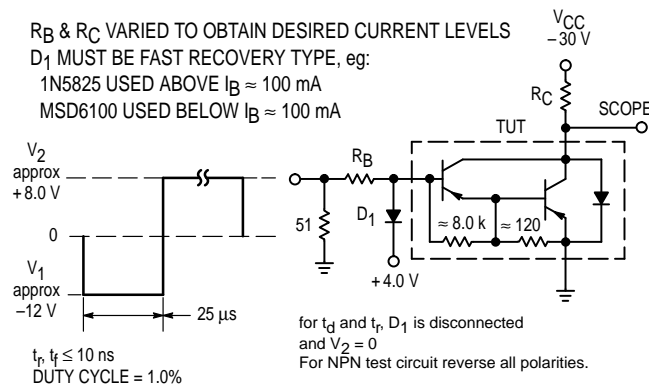

Figure 2. Switching Times Test Circuit

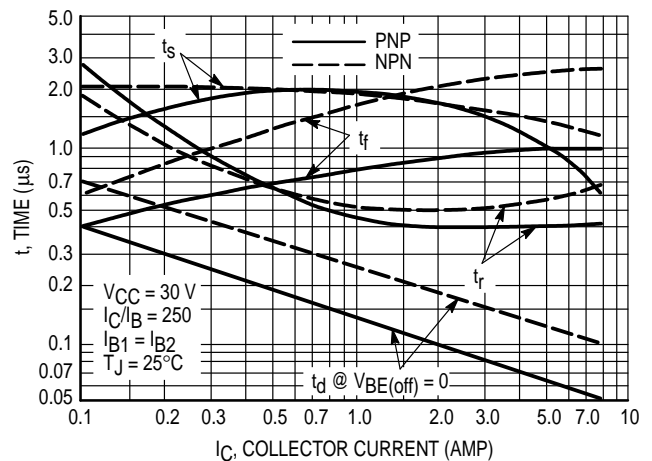

Figure 3. Switching Times

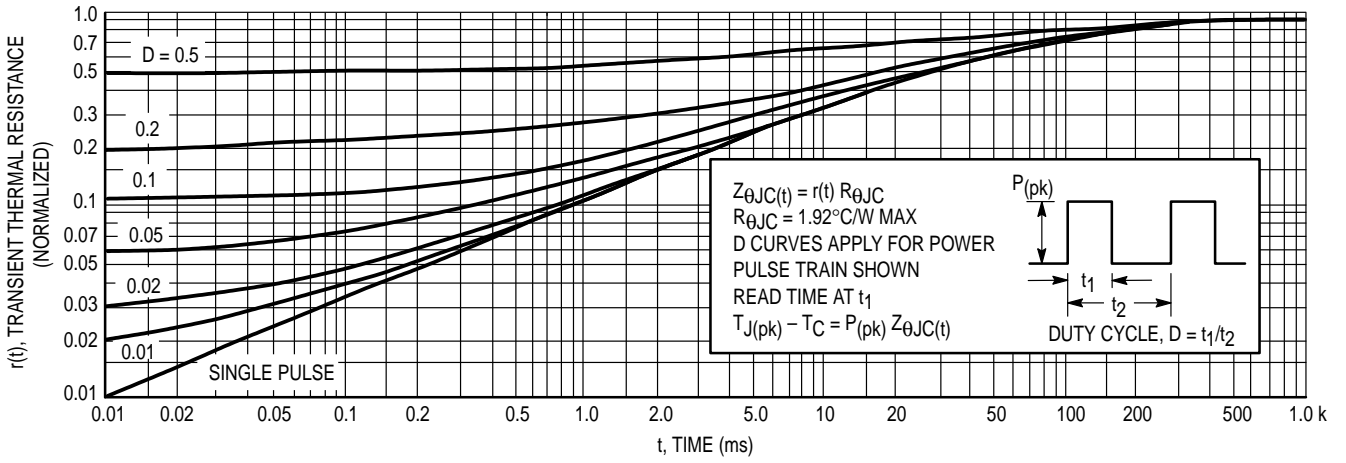

Figure 4. Thermal Response

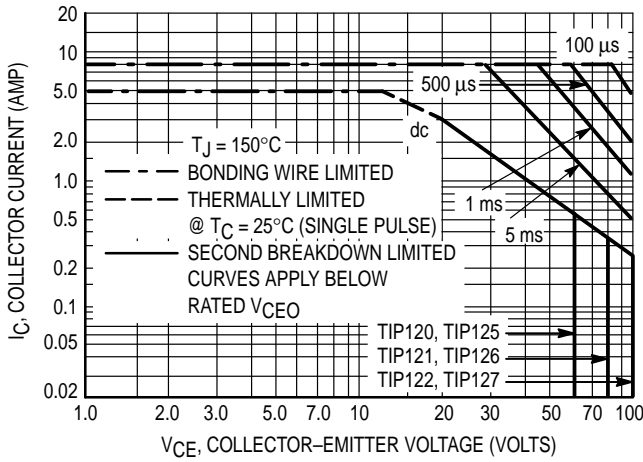

Figure 5. Active-Region Safe Operating Area

There are two limitations on the power handling ability of a transistor: average junction temperature and second breakdown. Safe operating area curves indicate $I_C - V_{CE}$ limits of the transistor that must be observed for reliable operation, i.e., the transistor must not be subjected to greater dissipation than the curves indicate.

The data of Figure 5 is based on $T_{J(pk)} = 150^{\circ}\text{C}$; T_C is variable depending on conditions. Second breakdown pulse limits are valid for duty cycles to 10% provided $T_{J(pk)} < 150^{\circ}\text{C}$. $T_{J(pk)}$ may be calculated from the data in Figure 4. At high case temperatures, thermal limitations will reduce the power that can be handled to values less than the limitations imposed by second breakdown

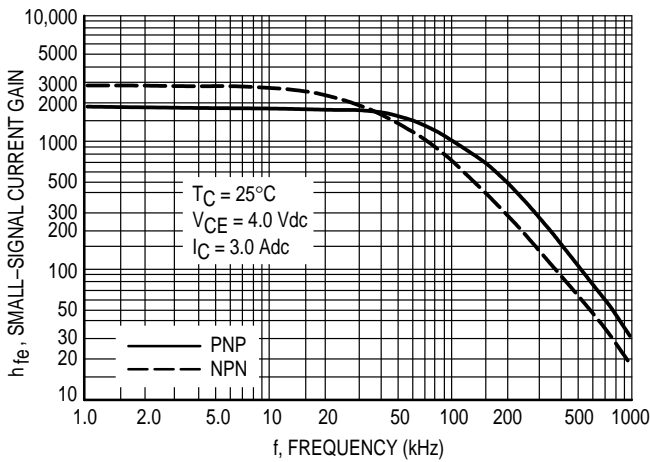

Figure 6. Small-Signal Current Gain

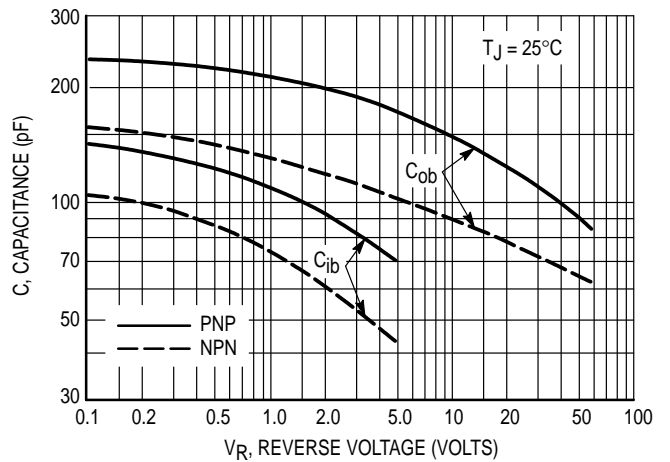

Figure 7. Capacitance

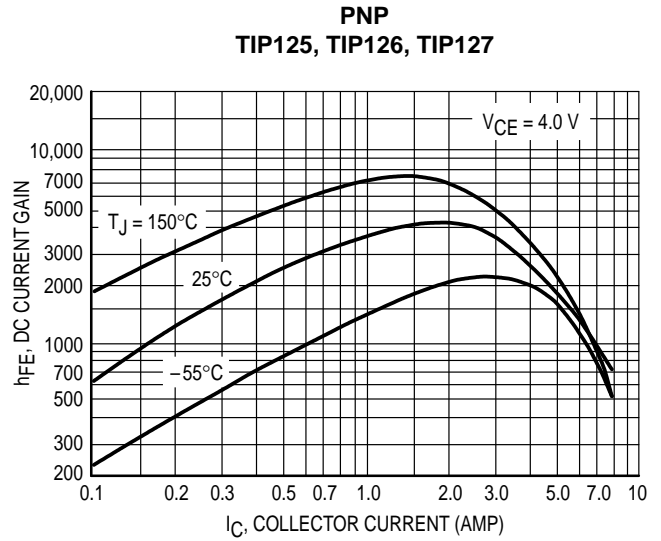
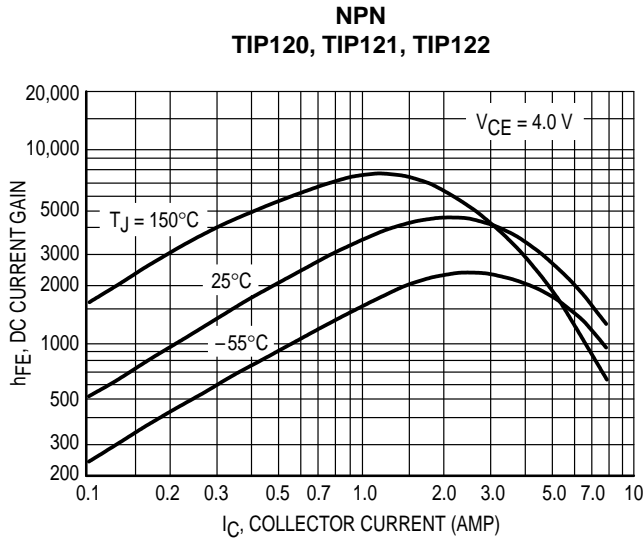

Figure 8. DC Current Gain

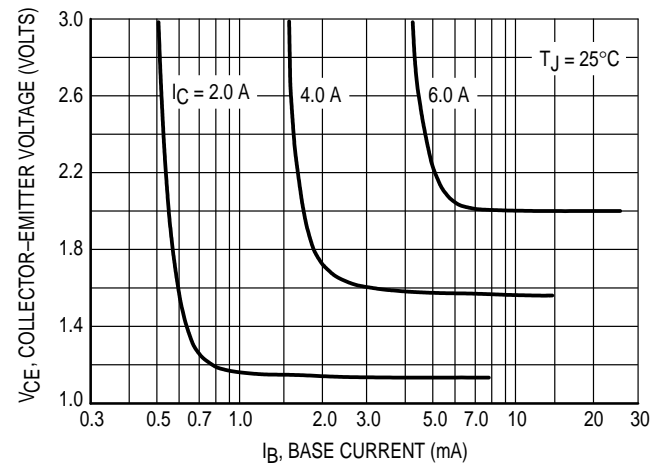
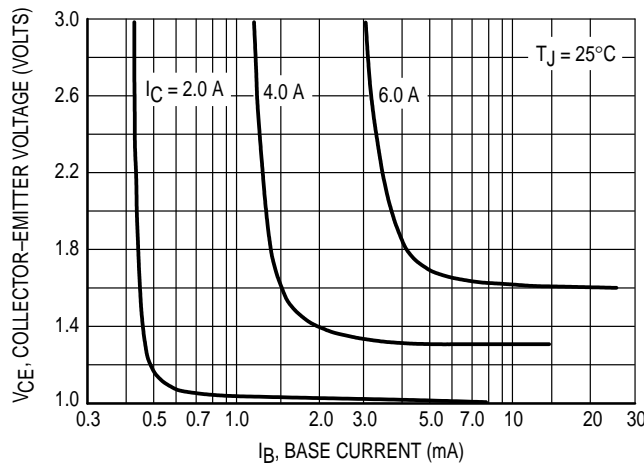

Figure 9. Collector Saturation Region

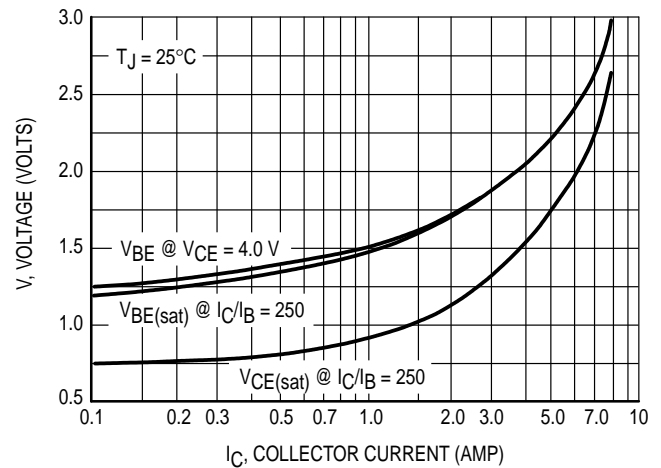
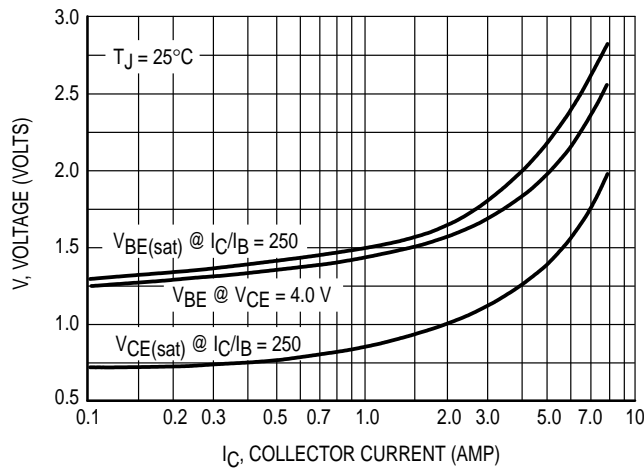
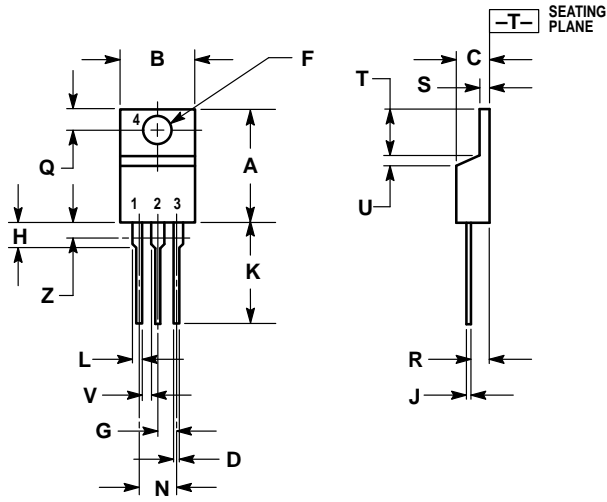

Figure 10. "On" Voltages

TIP120 TIP121 TIP122 TIP125 TIP126 TIP127
PACKAGE DIMENSIONS



- NOTES:
1. DIMENSIONING AND TOLERANCING PER ANSI Y14.5M, 1982.
 2. CONTROLLING DIMENSION: INCH.
 3. DIMENSION Z DEFINES A ZONE WHERE ALL BODY AND LEAD IRREGULARITIES ARE ALLOWED.

| DIM | INCHES | | MILLIMETERS | |
|-----|--------|-------|-------------|-------|
| | MIN | MAX | MIN | MAX |
| A | 0.570 | 0.620 | 14.48 | 15.75 |
| B | 0.380 | 0.405 | 9.66 | 10.28 |
| C | 0.160 | 0.190 | 4.07 | 4.82 |
| D | 0.025 | 0.035 | 0.64 | 0.88 |
| F | 0.142 | 0.147 | 3.61 | 3.73 |
| G | 0.095 | 0.105 | 2.42 | 2.66 |
| H | 0.110 | 0.155 | 2.80 | 3.93 |
| J | 0.018 | 0.025 | 0.46 | 0.64 |
| K | 0.500 | 0.562 | 12.70 | 14.27 |
| L | 0.045 | 0.060 | 1.15 | 1.52 |
| N | 0.190 | 0.210 | 4.83 | 5.33 |
| Q | 0.100 | 0.120 | 2.54 | 3.04 |
| R | 0.080 | 0.110 | 2.04 | 2.79 |
| S | 0.045 | 0.055 | 1.15 | 1.39 |
| T | 0.235 | 0.255 | 5.97 | 6.47 |
| U | 0.000 | 0.050 | 0.00 | 1.27 |
| V | 0.045 | — | 1.15 | — |
| Z | — | 0.080 | — | 2.04 |

- STYLE 1:
 PIN 1. BASE
 2. COLLECTOR
 3. EMITTER
 4. COLLECTOR

CASE 221A-06
TO-220AB
ISSUE Y

Motorola reserves the right to make changes without further notice to any products herein. Motorola makes no warranty, representation or guarantee regarding the suitability of its products for any particular purpose, nor does Motorola assume any liability arising out of the application or use of any product or circuit, and specifically disclaims any and all liability, including without limitation consequential or incidental damages. "Typical" parameters can and do vary in different applications. All operating parameters, including "Typicals" must be validated for each customer application by customer's technical experts. Motorola does not convey any license under its patent rights nor the rights of others. Motorola products are not designed, intended, or authorized for use as components in systems intended for surgical implant into the body, or other applications intended to support or sustain life, or for any other application in which the failure of the Motorola product could create a situation where personal injury or death may occur. Should Buyer purchase or use Motorola products for any such unintended or unauthorized application, Buyer shall indemnify and hold Motorola and its officers, employees, subsidiaries, affiliates, and distributors harmless against all claims, costs, damages, and expenses, and reasonable attorney fees arising out of, directly or indirectly, any claim of personal injury or death associated with such unintended or unauthorized use, even if such claim alleges that Motorola was negligent regarding the design or manufacture of the part. Motorola and  are registered trademarks of Motorola, Inc. Motorola, Inc. is an Equal Opportunity/Affirmative Action Employer.

How to reach us:

USA / EUROPE: Motorola Literature Distribution;
P.O. Box 20912; Phoenix, Arizona 85036. 1-800-441-2447

JAPAN: Nippon Motorola Ltd.; Tatsumi-SPD-JLDC, Toshikatsu Otsuki,
6F Seibu-Butsuryu-Center, 3-14-2 Tatsumi Koto-Ku, Tokyo 135, Japan. 03-3521-8315

MFAX: RMFAX0@email.sps.mot.com – TOUCHTONE (602) 244-6609
INTERNET: <http://Design-NET.com>

HONG KONG: Motorola Semiconductors H.K. Ltd.; 8B Tai Ping Industrial Park,
51 Ting Kok Road, Tai Po, N.T., Hong Kong. 852-26629298

