

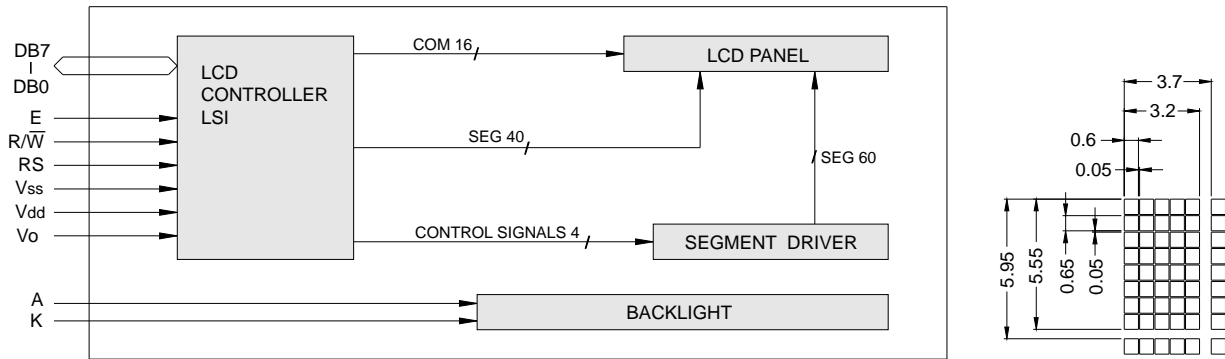

OUTLINE DIMENSION & BLOCK DIAGRAM

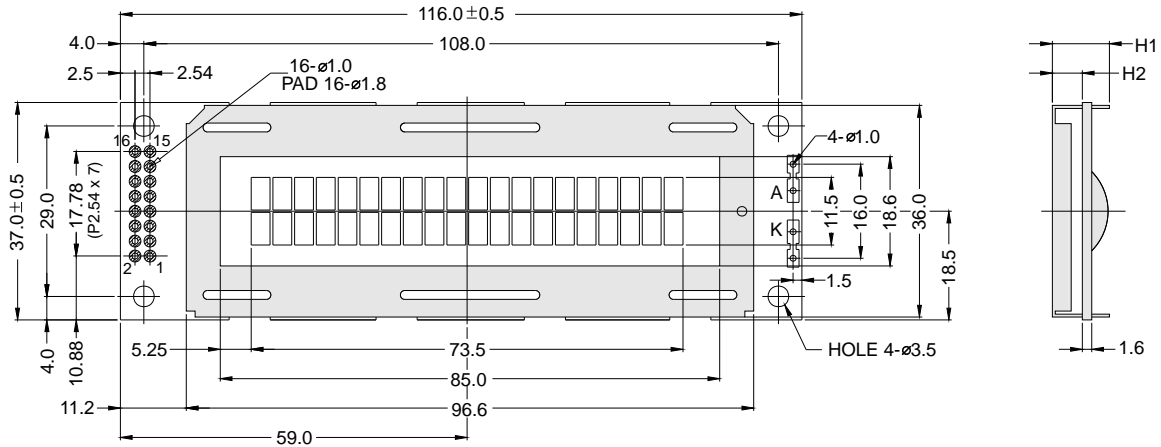

The tolerance unless classified $\pm 0.3\text{mm}$

MECHANICAL SPECIFICATION			
Overall Size	116.0 x 37.0	Module	H2 / H1
View Area	85.0 x 18.5	W / O B/L	5.1 / 9.7
Dot Size	0.60 x 0.65	EL B/L	5.1 / 9.7
Dot Pitch	0.65 x 0.70	LED B/L	9.4 / 14.0

PIN ASSIGNMENT		
Pin no.	Symbol	Function
1	Vss	Power supply(GND)
2	Vdd	Power supply(+)
3	Vo	Contrast Adjust
4	RS	Register select signal
5	R/W	Data read / write
6	E	Enable signal
7	DB0	Data bus line
8	DB1	Data bus line
9	DB2	Data bus line
10	DB3	Data bus line
11	DB4	Data bus line
12	DB5	Data bus line
13	DB6	Data bus line
14	DB7	Data bus line
15	A	Power supply for LED B/L (+)
16	K	Power supply for LED B/L (-)

ABSOLUTE MAXIMUM RATING									
Item	Symbol	Condition	Min.	Max.	Units				
Supply for logic voltage	Vdd-Vss	25°C	-0.3	7	V				
LCD driving supply voltage	Vdd-Vee	25°C	-0.3	13	V				
Input voltage	Vin	25°C	-0.3	Vdd+0.3	V				
ELECTRICAL CHARACTERISTICS									
Item	Symbol	Condition	Min.	Typical	Max.	Units			
Power supply voltage	Vdd-Vss	25°C	2.7	-	5.5	V			
LCD operation voltage	Vop	Top	N	W	N	W	V		
		-20°C	-	7.1	-	7.5	-	V	
		0°C	4.3	-	4.7	-	4.9	-	V
		25°C	4.2	6.1	4.4	6.4	4.3	6.7	V
		50°C	3.7	-	3.8	-	3.9	-	V
		70°C	-	5.7	-	6	-	6.3	V
LCM current consumption (No B/L)	Idd	Vdd=5V	-	2	3	mA			
Backlight current consumption	LED/edge	VB/L=4.2V	-	-	-	mA			
	LED/array	VB/L=4.2V	-	210	-	mA			

REMARK

LCD option: STN, TN, FSTN

Backlight Option: LED, EL Backlight feature, other Specs not available on catalog is under request.

