

SANYO	No.2740B	LA7955
	Video Switch for TV / VCR Use	

Overview

The LA7955 Video Switch IC is used to switch the video and audio signals of TVs, VCRs and similar equipment. Separate pin layouts for the video and audio systems facilitate board design. Two signals can be selected from the three input signals in a symmetrical arrangement using a control signal. Low impedance lines (V_{CC} , GND and control input) between the input and output pins minimize crosstalk caused by the high frequency of the video section. The LA7955 operates on a 12V power supply and is available in 20-pin plastic slim DIPs.

Functions

- Video applications : 3 inputs, 2 outputs
- Audio applications : 3 inputs, 2 outputs \times 2 (L,R) channels
- Built-in muting circuits for 2 left and 2 right audio output channels

Features

- Separate video and audio pin layouts
- Built-in 6dB video amps
- Wideband characteristics
- Minimal video and audio crosstalk
- 12V power supply
- 20-pin plastic slim DIP

Maximum Ratings at $T_a = 25^\circ\text{C}$

Maximum Supply Voltage	$V_{6\text{max}}$		14.4	V
Maximum Control Signal Voltage	$V_{4\text{max}}, V_{8\text{max}}, V_{10\text{max}}$		14.4	V
Allowable Power Dissipation	$P_{d\text{max}}$	$T_a \leq 70^\circ\text{C}$	700	mW
Operating Temperature	T_{opr}		-20 to +70	$^\circ\text{C}$
Storage Temperature	T_{stg}		-55 to +125	$^\circ\text{C}$

Recommended Operating Conditions at $T_a = 25^\circ\text{C}$

Recommended Supply Voltage	V_{CC}	12	V
Operating Supply Voltage Range	$V_{CC\text{op}}$	8 to 13.2	V

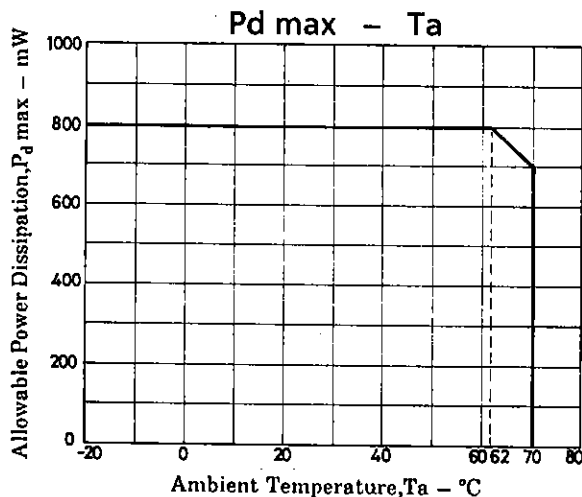

Package Dimensions

(unit : mm)

3021B

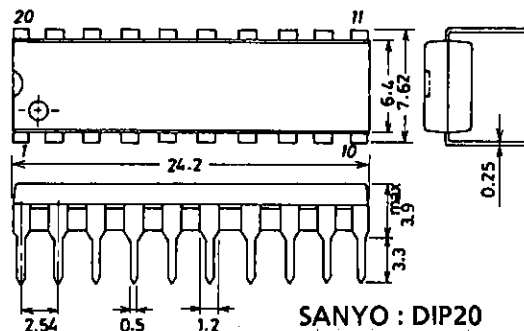

LA7955

Operating Characteristics at $T_a = 25^\circ\text{C}$, $V_{CC} = 12\text{V}$				min	typ	max	unit
Quiescent Current	I_{CC}			35	43	57	mA
Video Input Bias Voltage	V_1, V_3, V_7			4.4	4.7	5.0	V
Video Output Bias Voltage	V_5, V_9			6.2	6.8	7.4	V
Video Input Impedance	Z_1, Z_3, Z_7	$f = 1\text{kHz}$		15	21	27	k Ω
Video Output Impedance	Z_5, Z_9	$f = 1\text{kHz}$			42		Ω
Video Voltage Gain	G_{VV}	$V_{in} = 1\text{V}_{p-p}$ (sine wave) $f = 0.1\text{MHz}$		5.6	6.1	6.6	dB
Video Frequency Bandwidth	BW_V	$V_{in} = 0.7\text{V}_{p-p}$ (sine wave) - 3dB band for 0.1MHz		10			MHz
Output Noise Voltage	V_{NV}	$R_g = 75\Omega, 10\text{MHz}$ band			0.3	1.0	mVrms
Video Crosstalk (between inputs 1 and 2)	CT_{V1}	$R_g = 75\Omega, f = 3.58\text{MHz}$		45	50		dB
Video Crosstalk (between inputs 1 / 2 and 3)	CT_{V2}	$R_g = 75\Omega, f = 3.58\text{MHz}$		45	50		dB
Video Output Hum Rejection	HR_V	$f = 50\text{Hz}, R_g = 75\Omega$		18	23		dB
Audio Input Bias Voltage	V_{12}, V_{13}, V_{14} V_{17}, V_{18}, V_{19}			4.5	5.1	5.7	V
Audio Output Bias Voltage	$V_{11}, V_{15}, V_{18}, V_{20}$			3.2	3.8	4.4	V
Audio Input Impedance (inputs 1 and 2)	$Z_{12}, Z_{13}, Z_{15}, Z_{19}$	$f = 1\text{kHz}$		47	68	88	k Ω
Audio Input Impedance (input 3)	Z_{14}, Z_{17}	$f = 1\text{kHz}$		51	74	95	k Ω
Audio Output Impedance	$Z_{11}, Z_{15}, Z_{16}, Z_{20}$				75		Ω
Audio Voltage Gain	G_{VA}	$f = 1\text{kHz}, V_{in} = 500\text{mVrms}$ - 1dB band		-0.5	-0.02	+0.5	dB
Audio Frequency Bandwidth	BW_A	($V_{in} = 500\text{mVrms}$) for $f = 1\text{kHz}$ gain		100			kHz
Total Harmonic Distortion	THD	$f = 1\text{kHz}, V_{in} = 500\text{mVrms}$			0.03	0.2	%
Output Noise Voltage	V_{nA}	$R_g = 600\Omega, 20\text{Hz}$ to 20kHz bandwidth			10	50	μVrms
Audio Crosstalk (between inputs 1 and 2)	CT_{A1}	$R_g = \text{less than } 4.7\text{k}\Omega$ $f = 1\text{kHz}$ ($V_{in} = 500\text{mVrms}$)		75	90		dB
Audio Crosstalk (between inputs 1 / 2 and 3)	CT_{A2}	$R_g = \text{less than } 4.7\text{k}\Omega$ $f = 1\text{kHz}$ ($V_{in} = 500\text{mVrms}$)		75	90		dB
Audio Crosstalk (between L and R channels)	CT_{AS}	$R_g = 4.7\text{k}\Omega$ $f = 1\text{kHz}$ ($V_{in} = 500\text{mVrms}$)		72	82		dB
Mute Noise	V_{OAM}	$f = 1\text{kHz}$ $V_{in} = 500\text{mVrms}$			0.02	0.1	mVrms
Audio Hum Rejection 1	HR1	Input $R_g = 4.7\text{k}\Omega$		40	46		dB
Audio Hum Rejection 2	HR2	Input open		28	39		dB
Switching Control Signal Input High Threshold Voltage	V_{4TH}, V_{8TH}			1.1	1.4	1.7	V
Switching Control Signal Input Leak Current	I_{4L}, I_{8L}					-3	μA
Mute Input High Threshold Voltage	V_{10TH}			1.1	1.4	1.7	V
Mute Input Leak Current	I_{10L}					-3	μA

Note: The current flowing to the IC is positive and current from the IC is negative.

Equivalent Circuit Block Diagram

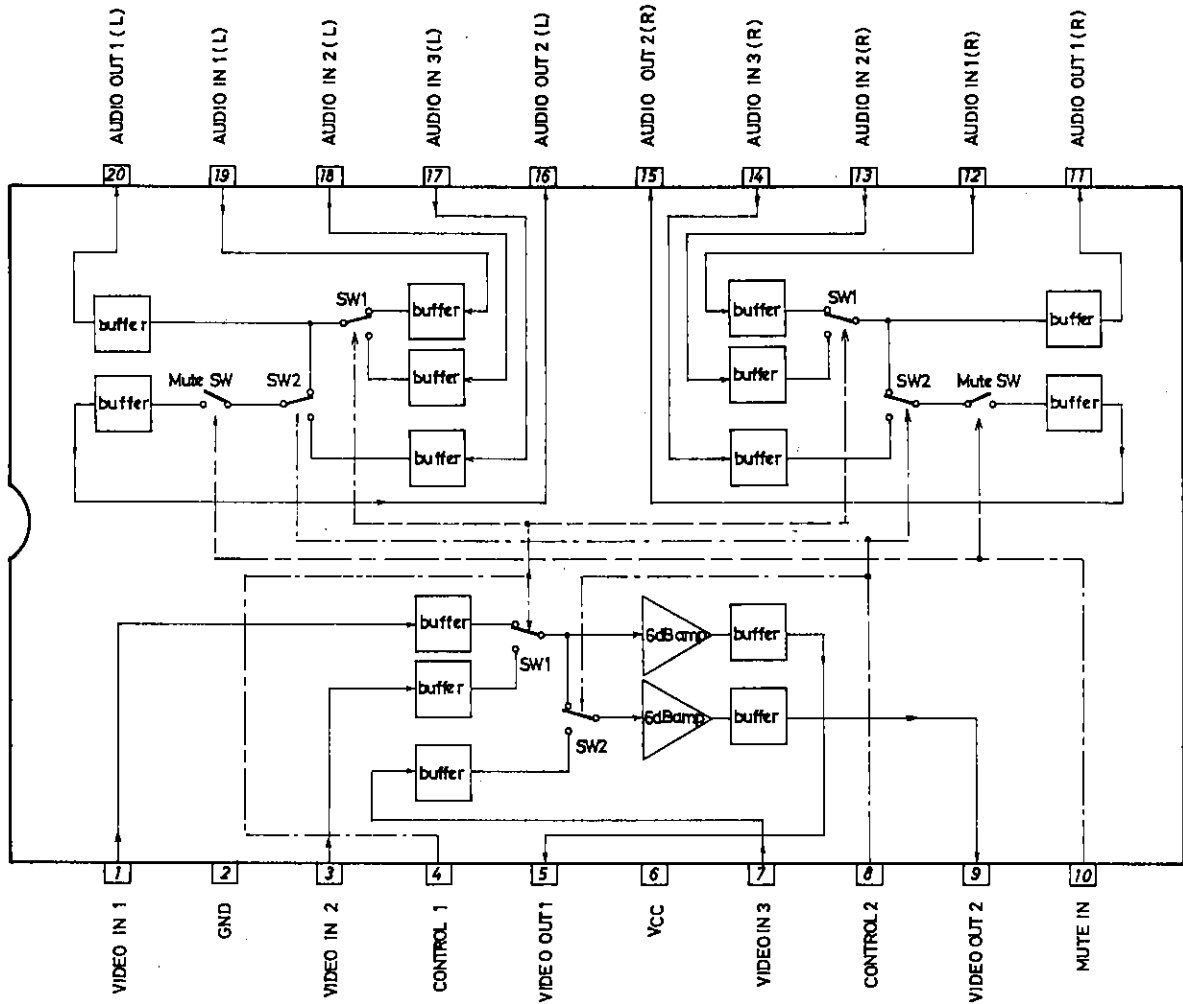

Switching Truth Table

CONTROL 1 (PIN 4)	CONTROL 2 (PIN 8)	MUTE IN (PIN 10)	VIDEO OUT		AUDIO OUT			
			1	2	1 L	2 L	1 R	2 R
L	L	L	IN 1	IN 1	IN 1	IN 1	IN 1	IN 1
L	H	L	IN 1	IN 3	IN 1	IN 3	IN 1	IN 3
H	L	L	IN 2	IN 2	IN 2	IN 2	IN 2	IN 2
H	H	L	IN 2	IN 3	IN 2	IN 3	IN 2	IN 3
L	L	H	IN 1	IN 1	IN 1	—	IN 1	—
L	H	H	IN 1	IN 3	IN 1	—	IN 1	—
H	L	H	IN 2	IN 2	IN 2	—	IN 2	—
H	H	H	IN 2	IN 3	IN 2	—	IN 2	—

Pinouts

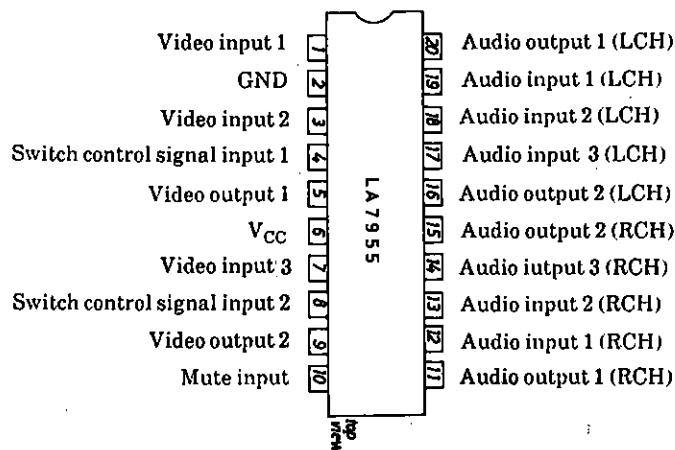

Sample Application Circuit

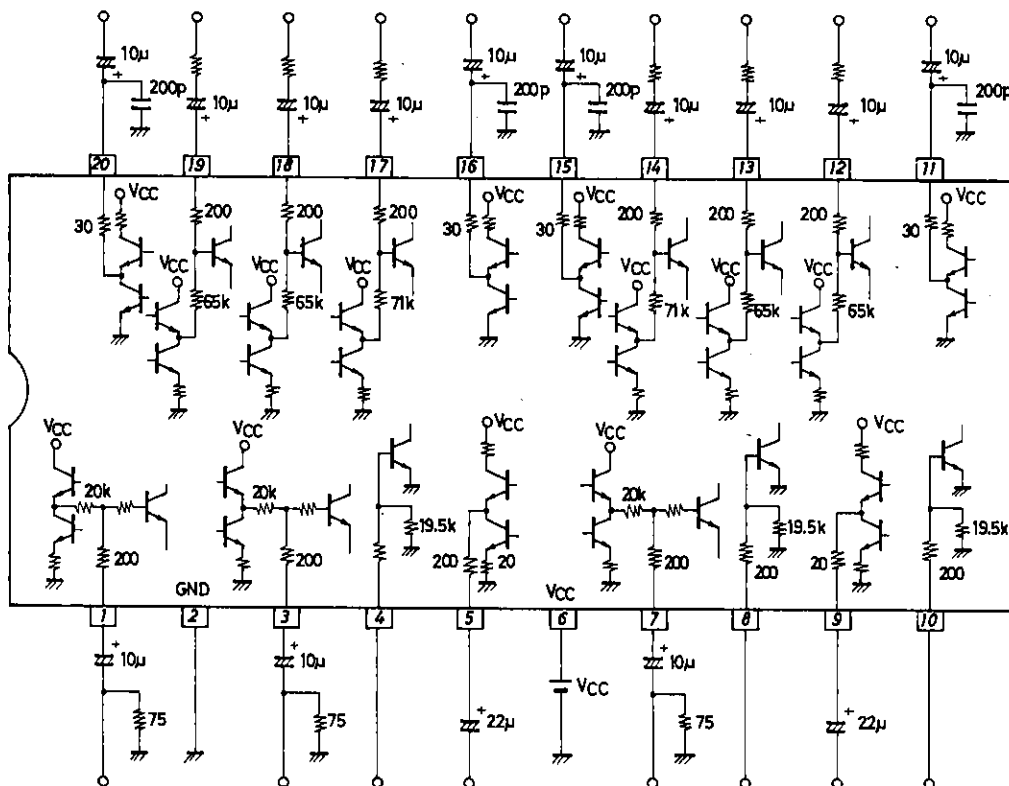

Unit (resistance:Ω, capacitance:F)

Circuit and Operational Description

1. Video input circuit

The video input circuit shown in the figure on the right has an input impedance of approximately 20kΩ. The input bias voltage is determined by the bias at point A, however, the voltage at this point fluctuates according to VCC.

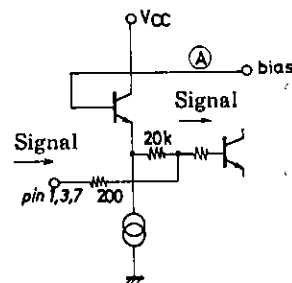

Unit (resistance:Ω)

2. Audio input circuit

The audio input circuit is shown in the figure on the right. The impedance of audio inputs 1 and 2 (Pins 12, 13, 18, and 19) is approximately 65kΩ, and that of audio input 3 (Pins 14 and 17), approximately 71kΩ. Although the input bias voltage is determined by the bias at point B, the voltage at point B is supplied from a low-noise Zener diode voltage regulator circuit and is not dependent on VCC.

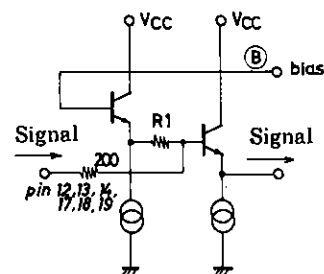

Unit (resistance:Ω)

3. Control signal input circuit

The circuit at input pins for the switching and muting circuits are shown in the figure on the right. The threshold voltage is approximately 1.4V.

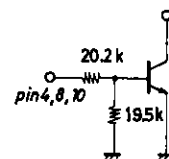

Unit (resistance:Ω)

4. Video output circuit

The video output is emitter follower output.

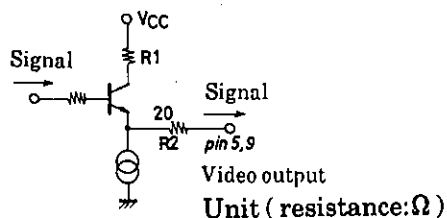

5. Audio output circuit

The audio output is emitter follower output.

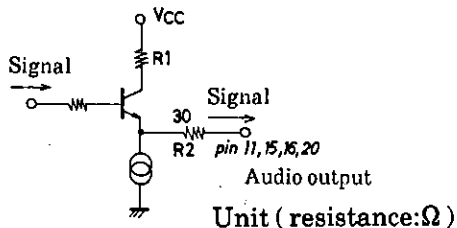

6. Video switch operation

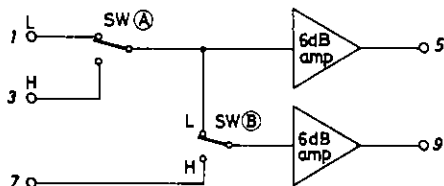

SW(A) is switched by the voltage of switching control input signal 1 (Pin 4), and SW(B), by the voltage of switching control input signal 2 (Pin 8). In addition, there are amplifiers (with 75Ω terminating output pins) with a gain of 6dB at the pre-output stages of Pins 5 and 9. However, an external buffer is required when shorted with a 75Ω resistor.

7. Audio switch operation

SW(A) is switched by the voltage of switching control input signal 1 (Pin 4), and SW(B), by the voltage of switching control input signal 2 (Pin 8). Setting the mute input voltage (Pin 10) to H turns the muting switch ON and cutting output 2.

Two pairs of audio switches are built in, allowing use in equipment designs for multiplex broadcast systems.

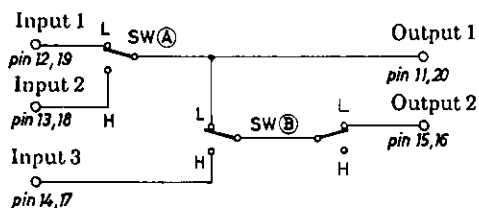

• Application Example 1 (TV with two video inputs)

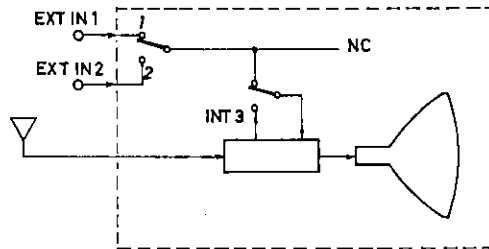

• Application Example 2 (TV with video inputs and VCR)

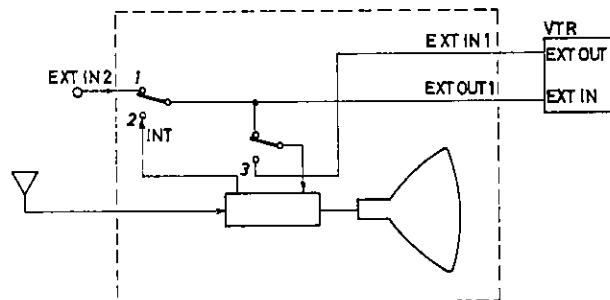

※ Audio output 2 is ideal for TV outputs as it has a built-in muting switch.

- No products described or contained herein are intended for use in surgical implants, life-support systems, aerospace equipment, nuclear power control systems, vehicles, disaster/crime-prevention equipment and the like, the failure of which may directly or indirectly cause injury, death or property loss.
- Anyone purchasing any products described or contained herein for an above-mentioned use shall:
 - ① Accept full responsibility and indemnify and defend SANYO ELECTRIC CO., LTD., its affiliates, subsidiaries and distributors and all their officers and employees, jointly and severally, against any and all claims and litigation and all damages, cost and expenses associated with such use;
 - ② Not impose any responsibility for any fault or negligence which may be cited in any such claim or litigation on SANYO ELECTRIC CO., LTD., its affiliates, subsidiaries and distributors or any of their officers and employees jointly or severally.
- Information (including circuit diagrams and circuit parameters) herein is for example only; it is not guaranteed for volume production. SANYO believes information herein is accurate and reliable, but no guarantees are made or implied regarding its use or any infringements of intellectual property rights or other rights of third parties.

This catalog provides information as of **December, 1996**. Specifications and information herein are subject to change without notice.