

4-channel BTL driver for CD players

BA6897S / BA6897FP

The BA6897S and BA6897FP are a 4-channel BTL driver for CD player motors and actuators. It has an internal 5V regulator and standard operational amplifier, and is suited to a wide range of applications.

●Applications

CD players, CD-ROM drives

●Features

- 1) Minimal number of external components.
- 2) Driver gain is adjustable with just one attached resistor.
- 3) Internal 5V regulator (attached PNP transistor necessary).
- 4) Internal standard operational amplifier.
- 5) Internal thermal shutdown circuit.

●Absolute maximum ratings (Ta = 25°C)

Parameter	Symbol	Limits	Unit
Power supply voltage	V _{CC}	18	V
Power dissipation	BA6897S	1.7*1	W
	BA6897FP	1.7*2	
Operating temperature	T _{opr}	-35~+85	°C
Storage temperature	T _{stg}	-55~+150	°C

*1 Unmounted

*2 When mounted on a 50 × 50 × 1 mm paper phenol board

Reduced by 13.6 mW for each increase in Ta of 1°C over 25°C.

●Recommended operating conditions (Ta = 25°C)

Parameter	Symbol	Limits	Unit
Power supply voltage	V _{CC}	6~9*2	V

*2 However, the driver can operate at up to 4.5V.

● Block diagram

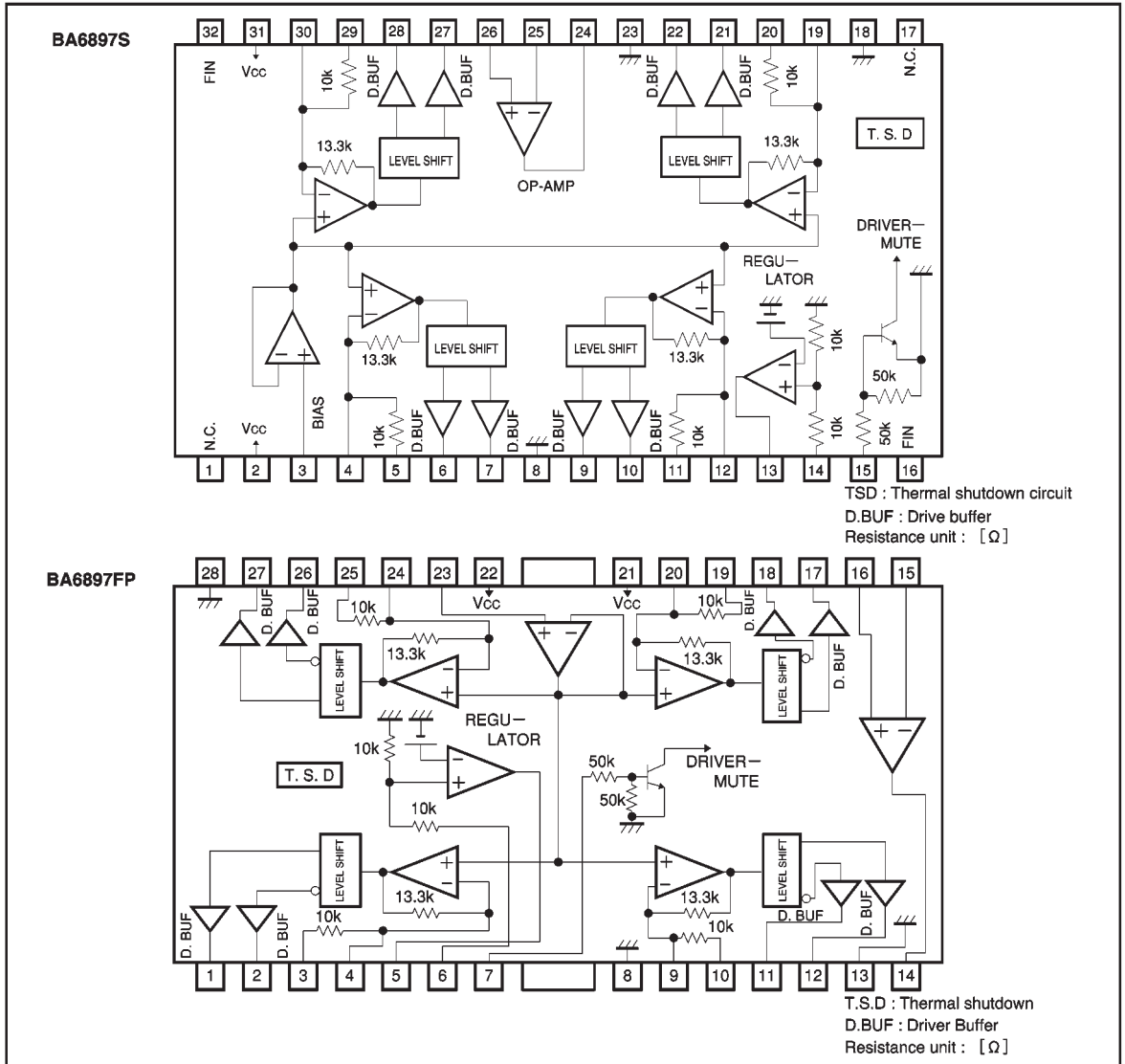

● Pin descriptions

BA6897S

Pin No.	Pin name	Function
1	N.C.	N.C.
2	V _{CC}	Power supply
3	BIAS IN	Bias amplifier input
4	VIN1'	Input for adjusting the driver channel 1 gain
5	VIN1	Driver channel 1 input
6	VO1 (+)	Driver channel 1 positive output
7	VO1 (-)	Driver channel 1 negative output
8	GND	Substrate ground
9	VO2 (-)	Driver channel 2 negative output
10	VO2 (+)	Driver channel 2 positive output
11	VIN2	Driver channel 2 input
12	VIN2'	Input for adjusting the driver channel 2 gain
13	REG-B	Connect to base of attached transistor
14	REG OUT	Constant voltage output (connect to collector of attached transistor)
15	MUTE	Mute control
16	FIN	FIN
17	N.C.	N.C.
18	GND	GND
19	VIN3'	Input for adjusting the driver channel 3 gain
20	VIN3	Driver channel 3 input
21	VO3 (+)	Driver channel 3 positive output
22	VO3 (-)	Driver channel 3 negative output
23	GND	Substrate ground
24	OP OUT	Operational amplifier output
25	OP IN (-)	Operational amplifier negative input
26	OP IN (+)	Operational amplifier positive input
27	VO4 (-)	Driver channel 4 positive output
28	VO4 (+)	Driver channel 4 negative output
29	VIN4	Driver channel 4 input
30	VIN4'	Input for adjusting the driver channel 4 gain
31	V _{CC}	Power supply
32	FIN	FIN

*Positive and negative output is relative to the polarity of the input pins.

BA6897FP

Pin No.	Pin name	Description
1	VO1 (−)	Driver channel 1 negative output
2	VO1 (+)	Driver channel 1 Positive output
3	VIN1	Driver channel 1 input
4	VIN1′	Driver channel 1 input, gain adjustment pin
5	REG−B	Connect to external transistor base
6	REG OUT	Constant voltage output, connects to external transistor collector
7	MUTE	Driver mute control input
8	GND	Ground
9	VIN2′	Driver channel 2 input, gain adjustment pin
10	VIN2	Driver channel 2 input
11	VO2 (+)	Driver channel 2 positive output
12	VO2 (−)	Driver channel 2 negative output
13	GND	Substrate ground
14	OP OUT	Operational amplifier output
15	OP IN(−)	Operational amplifier input, negative
16	OP IN(+)	Operational amplifier input, positive
17	VO3 (−)	Driver channel 3 negative output
18	VO3 (+)	Driver channel 3 Positive output
19	VIN3	Driver channel 3 input
20	VIN3′	Driver channel 3 input, gain adjustment pin
21	V _{CC}	Power supply
22	V _{CC}	Power supply
23	BIAS IN	Bias amplifier input
24	VIN4′	Driver channel 4 input, gain adjustment pin
25	VIN4	Driver channel 4 input
26	VO4 (+)	Driver channel 4 positive output
27	VO4 (−)	Driver channel 4 negative output
28	GND	Substrate ground

Note: Positive and negative output is relative to the polarity of the input pins.

● Input/output circuits

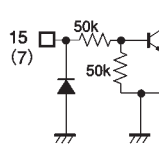
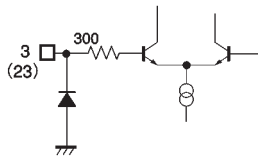
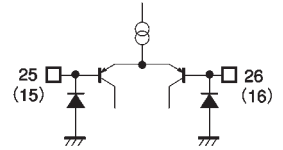
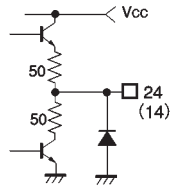
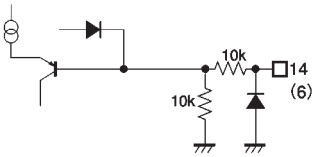
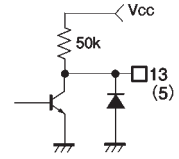
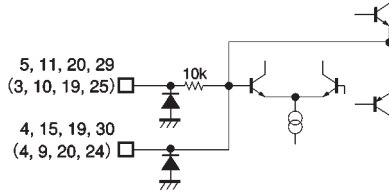
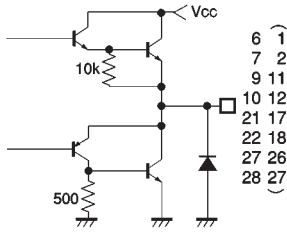

Values without parentheses are for BA6897S
 Values within parentheses are for BA6897FP

●Electrical characteristics (unless otherwise noted, $T_a = 25^\circ\text{C}$, $V_{CC} = 8\text{V}$, $f = 1\text{kHz}$, $R_L = 8\Omega$)

Parameter	Symbol	Min.	Typ.	Max.	Unit	Conditions
Quiescent current dissipation	I_{CC}	6.0	10.0	14.0	mA	No load
Output voltage, offset	V_{OO}	-40	—	40	mV	—
Max. output voltage, HIGH	V_{OHD}	5.2	5.6	—	V	—
Max. output voltage, LOW	V_{OLD}	—	1.3	1.55	V	—
Closed loop voltage gain	G_{VC}	7.0	8.0	9.0	dB	$V_{IN} = 0.1V_{rms}$, 1kHz
Ripple rejection	RR	—	60	—	dB	$V_{IN} = 0.1V_{rms}$, 100Hz
Slew rate	SR	—	2.0	—	$V/\mu s$	100 kHz square wave, 3 V_{P-P} output
Mute Off voltage	V_{MOFF}	2.0	—	—	V	—
〈5 V regulator〉						
Output voltage	V_{REG}	4.75	5.00	5.25	V	$I_L = 100\text{mA}$
Output load differential	ΔV_{RL}	-50	0	10	mV	$I_L = 0 \sim 200\text{mA}$
Power supply voltage differential	ΔV_{VCC}	-10	0	25	mV	($V_{CC} = 6 \sim 9\text{V}$) $I_L = 100\text{mA}$
〈Operational amplifier〉						
Offset voltage	V_{OFOP}	-5	0	5	mV	—
Input bias current	V_{BOP}	—	—	300	nA	—
Output high level voltage	V_{OHOP}	6.0	—	—	V	—
Output low level voltage	V_{OLOP}	—	—	1.8	V	—
Output drive current (sink)	I_{SINK}	10	50	—	mA	50Ω at V_{CC}
Output drive current (source)	I_{SOURCE}	10	40	—	mA	50Ω at GND
Open loop voltage gain	G_{VO}	—	78	—	dB	$V_{IN} = -75\text{dBV}$, 1kHz
Slew rate	SR_{OP}	—	1	—	$V/\mu s$	100 kHz square wave, 4 V_{P-P} output
Ripple rejection	RR_{OP}	—	65	—	dB	$V_{IN} = -20\text{dBV}$, 100Hz
Common mode rejection ratio	$CMRR$	—	84	—	dB	$V_{IN} = -20\text{dBV}$, 1kHz

● Measurement circuit (BA6897S)

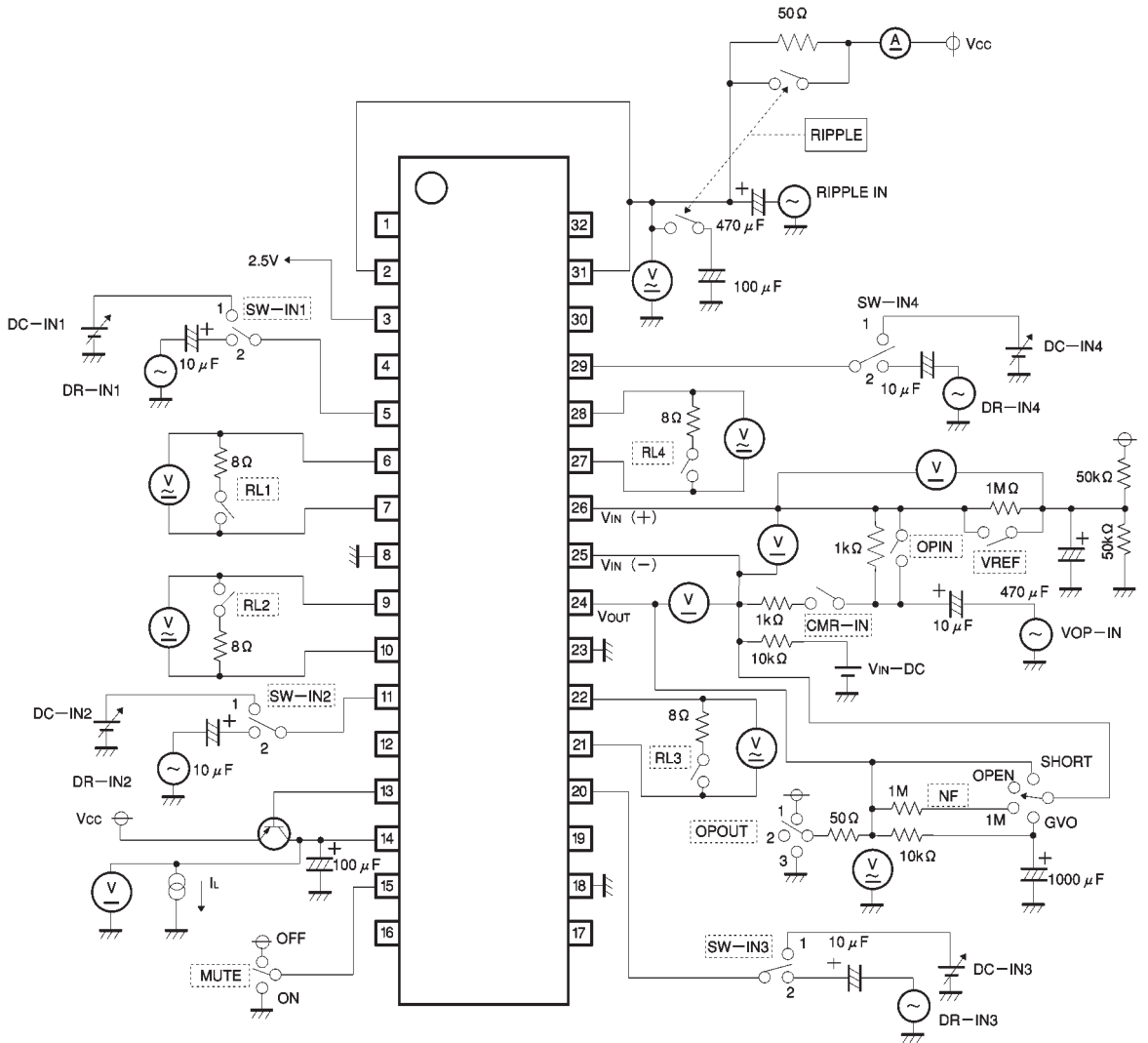

Fig.1

● Circuit operation

(1) Driver

Inputs to the IC are the focus tracking error signal from the servo preamplifier and the control signal from the motor.

The input signals, which normally center on 2.5V, are V/I converted by the preamplifier, generating a current corresponding to the input voltage. This current is passed through a resistor and into the internal reference voltage component, the preamplifier output being a signal centering on the internal reference voltage. Two systems (positive phase and negative phase) are created during V/I conversion, generating BTL output via the driver buffer.

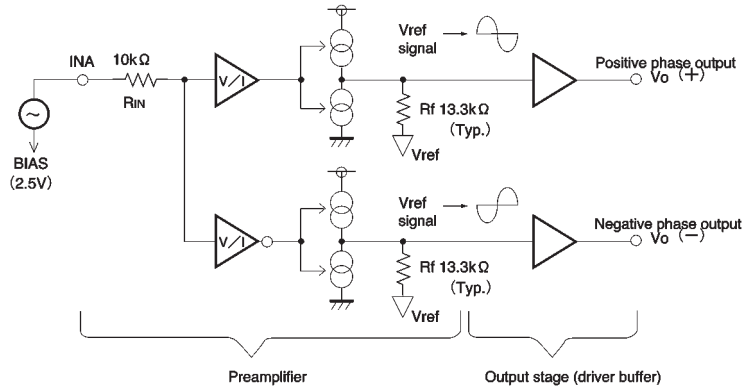

Fig. 2

(2) Regulator

This is a typical series regulator that generates a reference voltage internally. A PNP low saturation transistor must be connected.

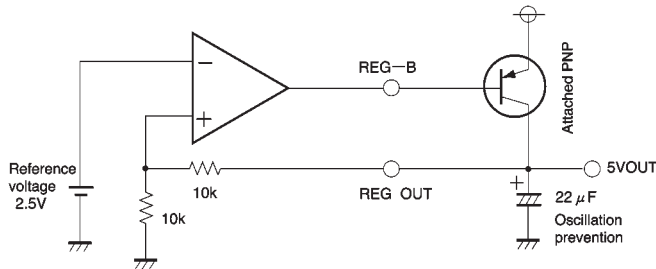

Fig. 3

(3) Amplifier

General 4558 type.

● Application examples

BA6897S

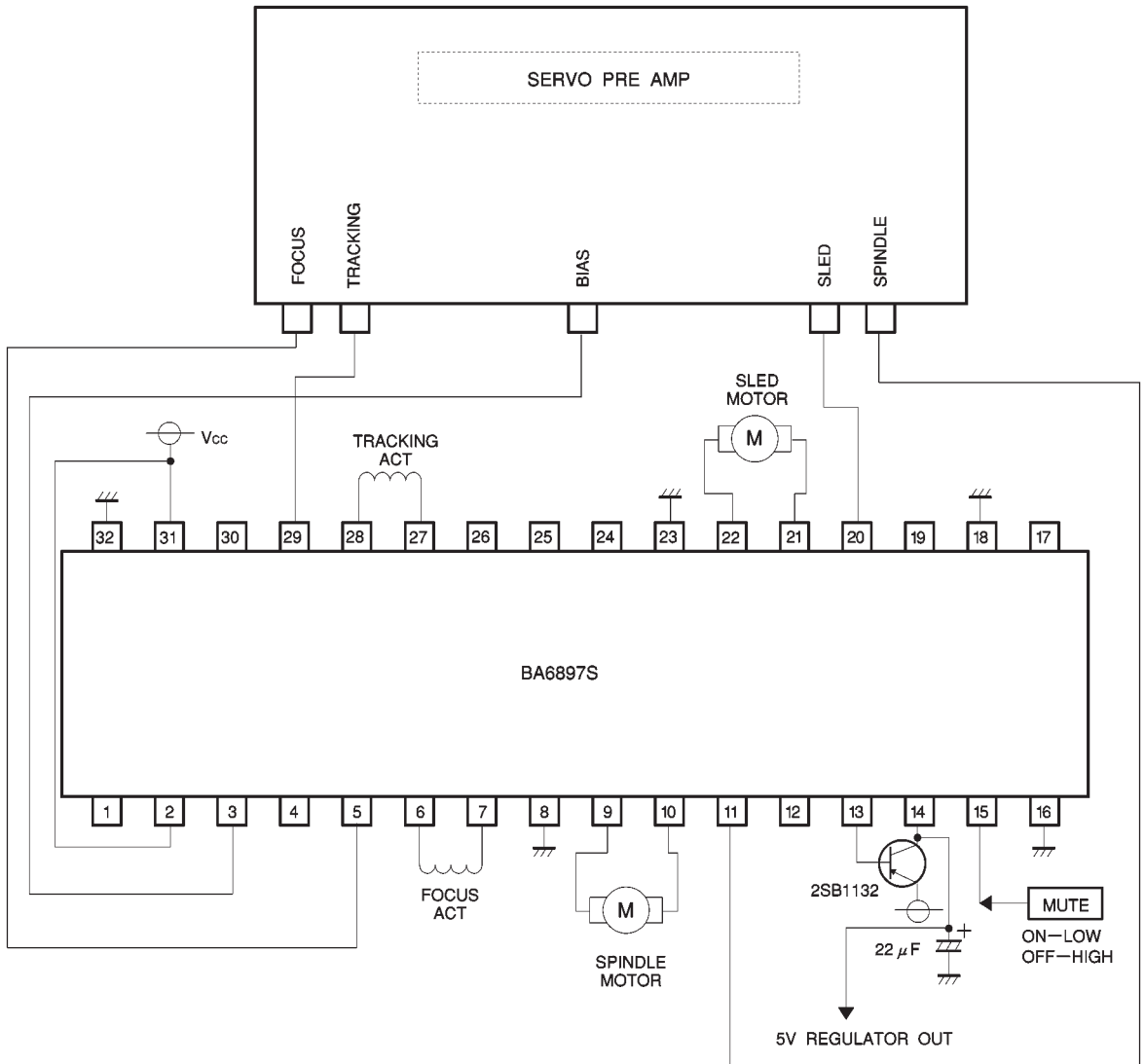

Fig.4

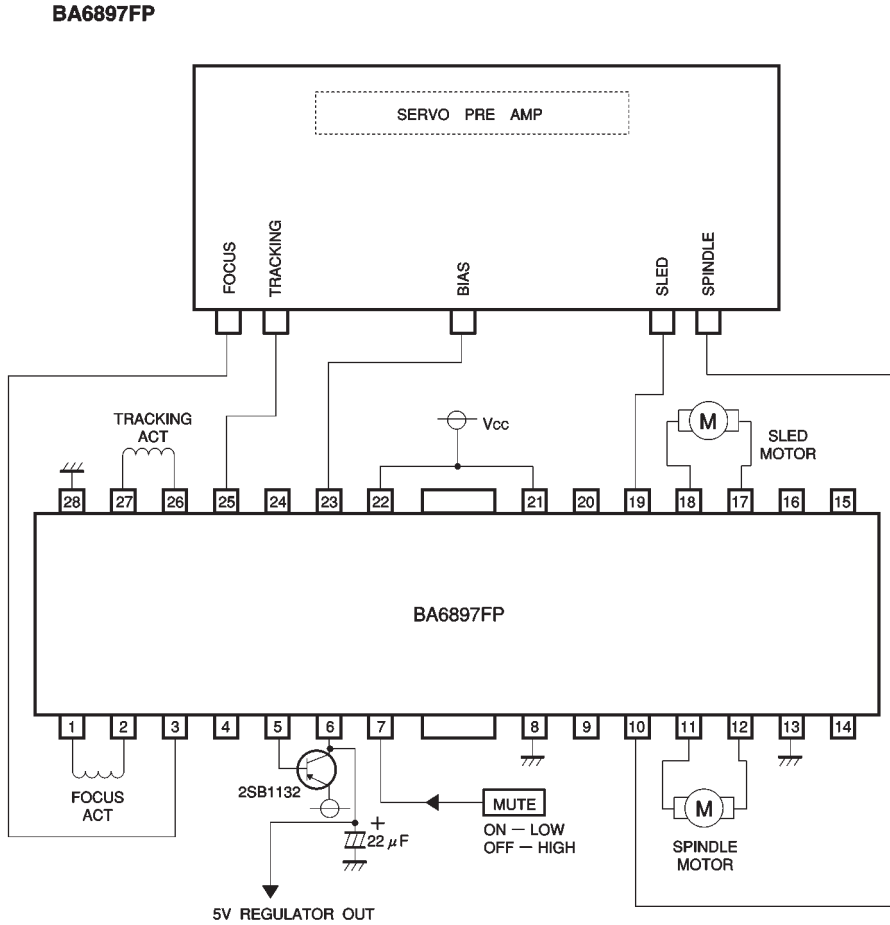

Fig.5

● Operation notes

- (1) The BA6897S and BA6897FP have an internal thermal shutdown circuit. Output current is muted when the chip temperature exceeds 175°C (typically).
- (2) If the mute pin voltage is opened or lowered below 0.5V, the output current will be muted. The mute pin should be pulled up above 2.0V during normal use.
- (3) The bias pin is muted when lowered below 1.4V (typically). Make sure it stays above 1.6V during normal use.
- (4) Muting occurs during thermal shutdown, mute-on operations or a drop in the bias pin voltage or supply voltage.

- (5) Be sure to connect the IC to a 0.1μF bypass capacitor to the power supply, at the base of the IC.
- (6) The radiating fin is connected to the packages internal GND, but should also be connected to an external ground.
- (7) The capacitor between regulator output (pin 6) and GND also serves to prevent oscillation of the IC, so select one with good temperature characteristics.

● Electrical characteristic curves

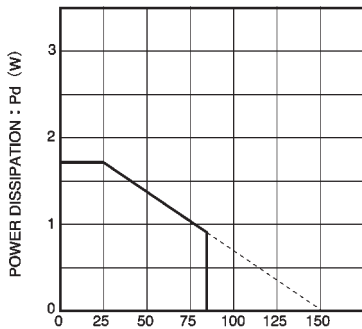

AMBIENT TEMPERATURE : Ta (°C)
 BA6897S, When separate
 BA 6897FP, PCB When mounted
 on a 50×50×1 mm paper phenol board.

Fig. 6 Thermal derating curve

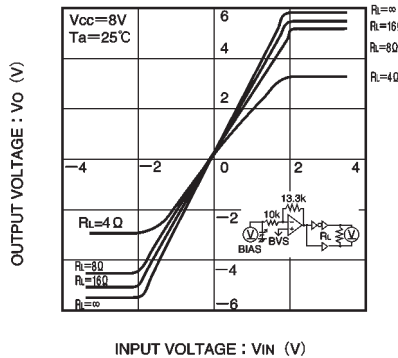

Fig. 7 Driver I/O characteristics (variable load)

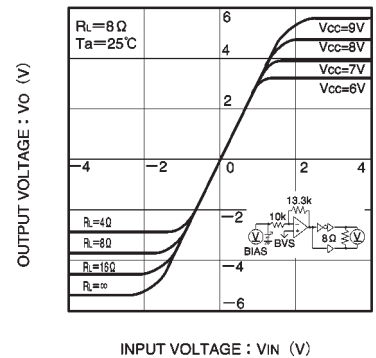

Fig. 8 Driver I/O characteristics (variable Vcc)

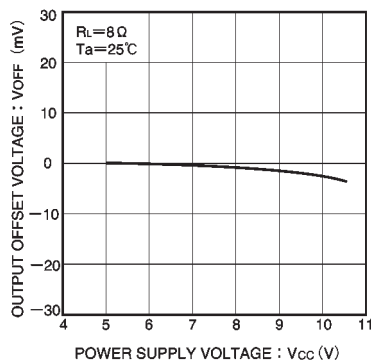

Fig. 9 Power supply voltage vs. output voltage (offset)

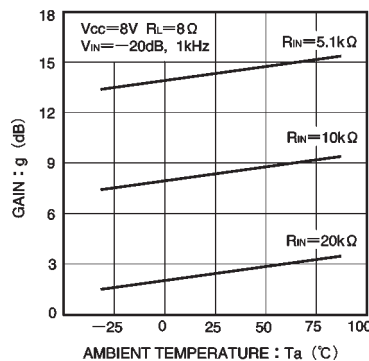

Fig. 10 Driver gain vs. temperature (Rin connected via gain adjustment pin)

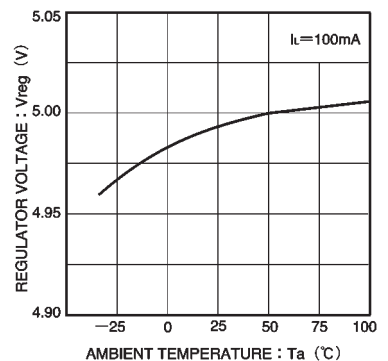

Fig. 11 Regulator voltage vs. temperature

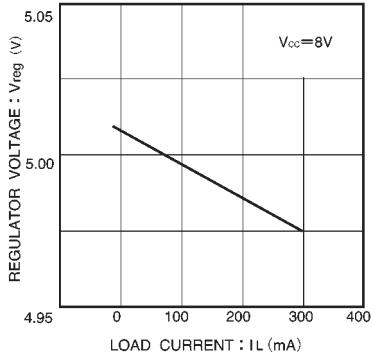

Fig. 12 Load current vs. regulator current

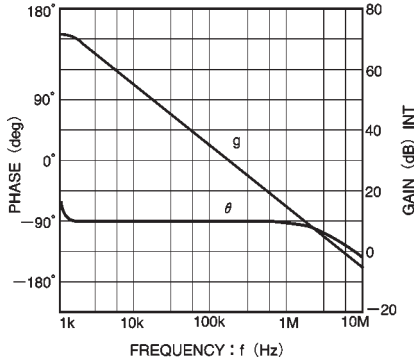

Fig. 13 Operational amplifier vs. open loop

● External dimensions (Units: mm)

