



# S DM9926A

## Dual N-Channel Enhancement Mode Field Effect Transistor

PRODUCT SUMMARY		
V <sub>DSS</sub>	I <sub>D</sub>	R <sub>DS(ON)</sub> ( mΩ ) TYP
20V	6A	26 @ V <sub>GS</sub> = 4.0V 35 @ V <sub>GS</sub> = 2.5V

### FEATURES

- Super high dense cell design for low R<sub>DS(ON)</sub>.
- Rugged and reliable.
- Surface Mount Package.

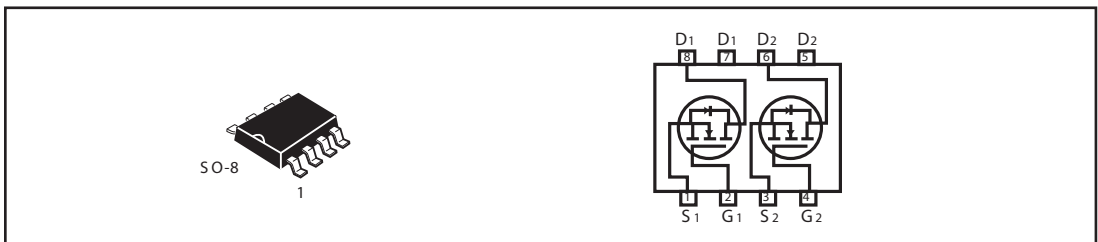

### ABSOLUTE MAXIMUM RATINGS (T<sub>A</sub>=25 °C unless otherwise noted)

Parameter	Symbol	Limit	Unit
Drain-Source Voltage	V <sub>DS</sub>	±20	V
Gate-Source Voltage	V <sub>GS</sub>	±8	V
Drain Current-Continuous <sup>a</sup> @ T <sub>J</sub> =125 °C -Pulsed <sup>b</sup> (300us Pulse Width)	I <sub>D</sub>	6.0	A
	I <sub>DM</sub>	35	A
Drain-Source Diode Forward Current <sup>a</sup>	I <sub>S</sub>	1.7	A
Maximum Power Dissipation <sup>a</sup>	P <sub>D</sub>	2	W
Operating Junction and Storage Temperature Range	T <sub>J</sub> , T <sub>STG</sub>	-55 to 150	°C

### THERMAL CHARACTERISTICS

Thermal Resistance, Junction-to-Ambient <sup>a</sup>	R θJA	62.5	°C/W
--	-------	------	------

# S DM9926A

## ELECTRICAL CHARACTERISTICS (T<sub>A</sub>=25 °C unless otherwise noted)

Parameter	Symbol	Condition	Min	Typ <sup>c</sup>	Max	Unit
<b>OFF CHARACTERISTICS</b>						
Drain-Source Breakdown Voltage	BV <sub>DS</sub>	V <sub>GS</sub> = 0V, I <sub>D</sub> = 250μA	20			V
Zero Gate Voltage Drain Current	I <sub>DSS</sub>	V <sub>DS</sub> = 20V, V <sub>GS</sub> = 0V			1	μA
Gate-Body Leakage	I <sub>GSS</sub>	V <sub>GS</sub> = ±8V, V <sub>DS</sub> = 0V			±100	nA
<b>ON CHARACTERISTICS<sup>b</sup></b>						
Gate Threshold Voltage	V <sub>GS(th)</sub>	V <sub>DS</sub> = V <sub>GS</sub> , I <sub>D</sub> = 250μA	0.6			V
Drain-Source On-State Resistance	R <sub>DS(ON)</sub>	V <sub>GS</sub> = 4.0V, I <sub>D</sub> = 6.0A V <sub>GS</sub> = 2.5V, I <sub>D</sub> = 5.2A		26 35	30 40	m ohm
On-State Drain Current	I <sub>D(ON)</sub>	V <sub>DS</sub> = 5V, V <sub>GS</sub> = 4.5V	20			A
Forward Transconductance	g <sub>FS</sub>	V <sub>DS</sub> = 10V, I <sub>D</sub> = 6.0A		17		S
<b>DYNAMIC CHARACTERISTICS<sup>c</sup></b>						
Input Capacitance	C <sub>ISS</sub>	V <sub>DS</sub> = 8V, V <sub>GS</sub> = 0V f = 1.0MHz		720		pF
Output Capacitance	C <sub>OSS</sub>			320		pF
Reverse Transfer Capacitance	C <sub>RSS</sub>			90		pF
<b>SWITCHING CHARACTERISTICS<sup>c</sup></b>						
Turn-On Delay Time	t <sub>D(ON)</sub>	V <sub>DD</sub> = 10V, I <sub>D</sub> = 1A, V <sub>GEN</sub> = 4.5V, R <sub>L</sub> = 10 ohm R <sub>GEN</sub> = 6 ohm		20	40	ns
Rise Time	t <sub>r</sub>			18	35	ns
Turn-Off Delay Time	t <sub>D(OFF)</sub>			50	100	ns
Fall Time	t <sub>f</sub>			25	50	ns
Total Gate Charge	Q <sub>g</sub>	V <sub>DS</sub> = 10V, I <sub>D</sub> = 6A, V <sub>GS</sub> = 4.5V		13.5	17	nC
Gate-Source Charge	Q <sub>gs</sub>			3		nC
Gate-Drain Charge	Q <sub>gd</sub>			2		nC

# SDM9926A

## ELECTRICAL CHARACTERISTICS ( $T_A=25^\circ\text{C}$ unless otherwise noted)

Parameter	Symbol	Condition	Min	Typ <sup>c</sup>	Max	Unit
<b>DRAIN-SOURCE DIODE CHARACTERISTICS<sup>b</sup></b>						
Diode Forward Voltage	$V_{SD}$	$V_{GS} = 0V, I_s = 1.7A$		0.72	1.2	V

### Notes

- a. Surface Mounted on FR4 Board,  $t \leq 10\text{sec}$ .
- b. Pulse Test: Pulse Width  $\leq 300\mu\text{s}$ , Duty Cycle  $\leq 2\%$ .
- c. Guaranteed by design, not subject to production testing.

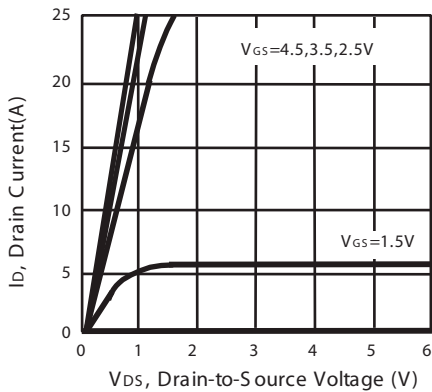

Figure 1. Output Characteristics

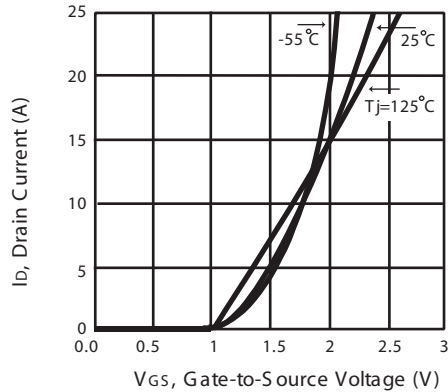

Figure 2. Transfer Characteristics

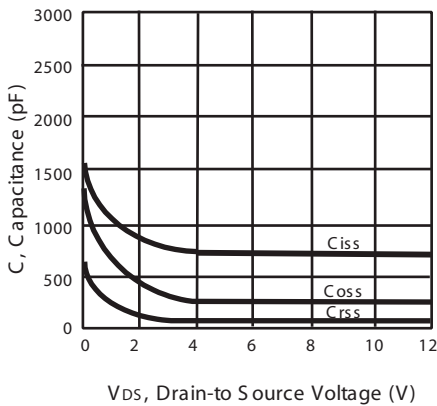

Figure 3. Capacitance

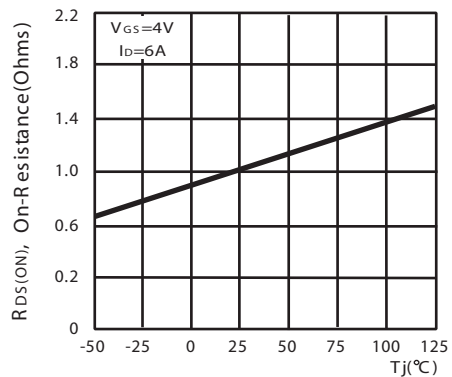

Figure 4. On-Resistance Variation with Temperature

# S DM9926A

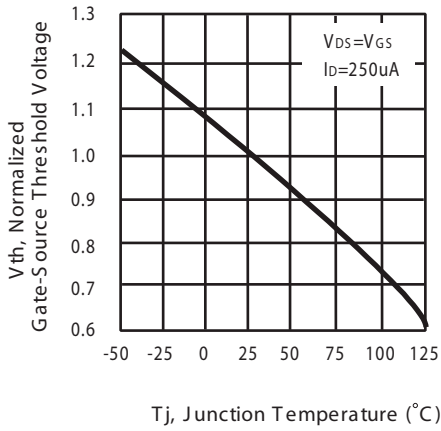

Figure 5. Gate Threshold Variation with Temperature

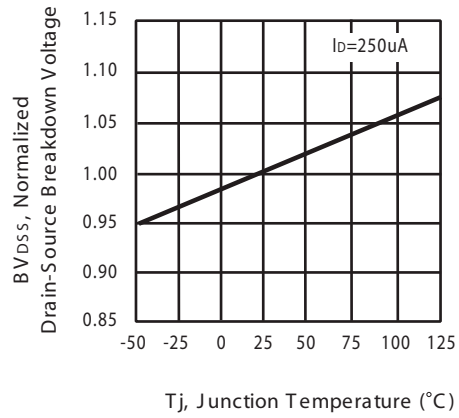

Figure 6. Breakdown Voltage Variation with Temperature

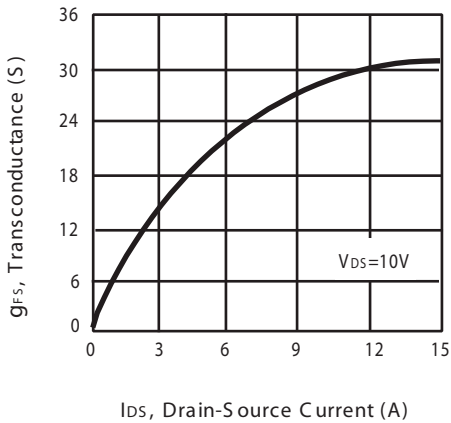

Figure 7. Transconductance Variation with Drain Current

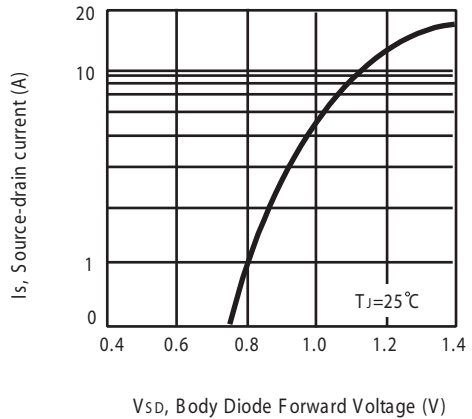

Figure 8. Body Diode Forward Voltage Variation with Source Current

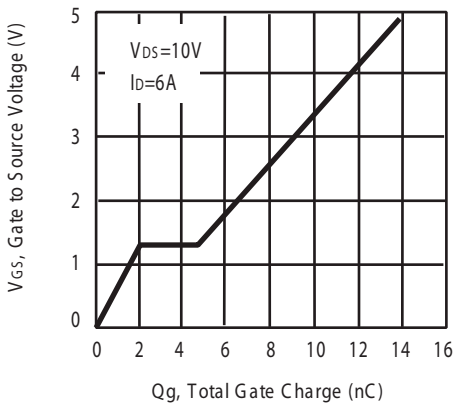

Figure 9. Gate Charge

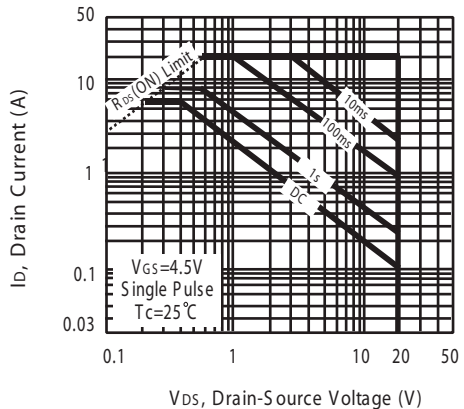

Figure 10. Maximum Safe Operating Area

# S DM9926A

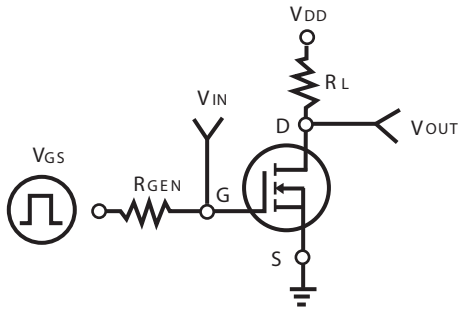

Figure 11. Switching Test Circuit

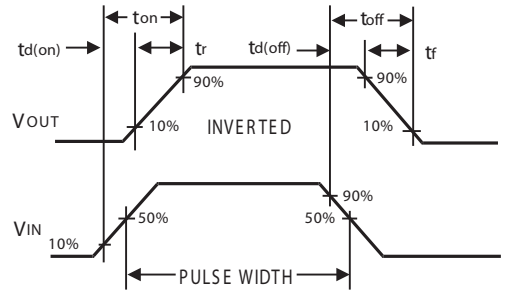

Figure 12. Switching Waveforms

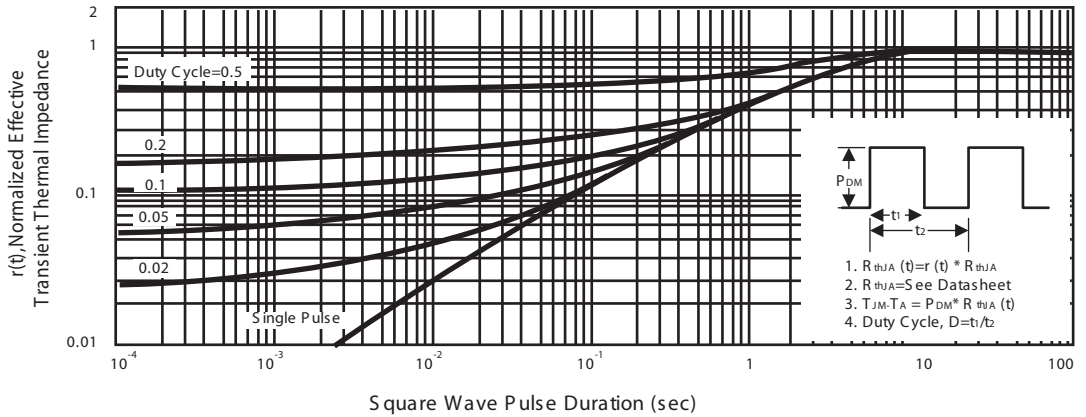

Figure 13. Normalized Thermal Transient Impedance Curve