

## Series PVA33N

Microelectronic Power IC  
HEXFET® Power MOSFET Photovoltaic Relay  
Single-Pole, Normally-Open  
0-300V AC/DC, 150mA

### General Description

The PVA33 Series AC Relay (PVA) is a single-pole, normally open, solid-state replacement for electromechanical relays used for general purpose switching of analog signals. It utilizes International Rectifier's HEXFET power MOSFETs as the output switches, driven by an integrated circuit photovoltaic generator of novel construction. The output switch is controlled by radiation from a GaAlAs light emitting diode (LED), which is optically isolated from the photovoltaic generator.

The PVA33 Series overcomes the limitations of both conventional electromechanical and reed relays by offering the solid state advantages of long life, fast operating speed, low pick up power, bounce-free operation, low thermal offset voltages and miniature package. These advantages allow product improvement and design innovations in many applications such as process control, multiplexing, automatic test equipment and data acquisition.

The PVA33 can switch analog signals from thermocouple level to 300 Volts peak AC or DC polarity. Signal frequencies into the RF range are easily controlled and switching rates up to 500Hz are achievable. The extremely small thermally generated offset voltages allow increased measurement accuracies.

These relays are packaged in 8-pin, molded DIP packages and available with either thru-hole or surface-mount ("gull-wing") leads, in plastic shipping tubes.

### Applications

- Process Control
- Data Acquisition
- Test Equipment
- Multiplexing and Scanning

### Features

- Bounce-Free Operation
- $10^{10}$  Off-State Resistance
- 1,000 V/ $\mu$ sec dv/dt
- 0.2  $\mu$ V Thermal Offset
- 5 mA Input Sensitivity
- 4,000 V<sub>RMS</sub> I/O Isolation
- Solid-State Reliability
- UL Recognized
- ESD Tolerance:
  - 4000V Human Body Model
  - 500V Machine Model

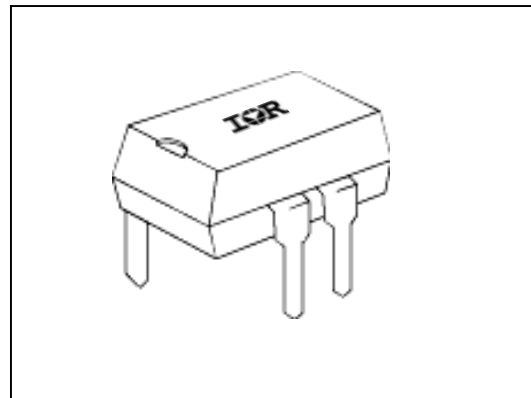

### Part Identification

PVA2352N	
PVA3324N	
PVA3354N	thru-hole
PVA2352NS	surface-mount
PVA3324NS	(gull-wing)
PVA3354NS	

*(HEXFET is the registered trademark for International Rectifier Power MOSFETs)*

## Series PVA33N

International  
**IR** Rectifier

### Electrical Specifications (-40°C ≤ T<sub>A</sub> ≤ +85°C unless otherwise specified)

INPUT CHARACTERISTICS	PVA2352N	PVA3324N	PVA3354N	Units
Minimum Control Current (see figures 1 and 2)				DC
For 60mA Continuous Load Current	–	1	–	mA@25°C
For 170mA Continuous Load Current	2	2	2	mA@25°C
For 100mA Continuous Load Current	5	2	5	mA@85°C
Maximum Control Current for Off-State Resistance at 25°C	10			µA(DC)
Control Current Range (Caution: current limit input LED. See figure 6)	2.0 to 25			mA(DC)
Maximum Reverse Voltage	7.0			V(DC)

OUTPUT CHARACTERISTICS	PVA2352N	PVA3324N	PVA3354N	Units
Operating Voltage Range	0 to ± 200	0 to ± 300		V <sub>(PEAK)</sub>
Maximum Load Current 40°C I LED 5mA	150			mA(DC)
Max. On-state Resistance 25°C (Pulsed) (fig. 4) 50 mA Load, 5mA Control	24			Ω
Min. Off-state Resistance @ 25°C (see figure 5)	10 <sup>8</sup> @160VDC	10 <sup>10</sup> @ 240VDC		Ω
Response Time @25°C (see figures 7 and 8)				
Max. T <sub>(on)</sub> @ 12mA Control, 50 mA Load, 100 VDC	100			µs
Max. T <sub>(off)</sub> @ 12mA Control, 50 mA Load, 100 VDC	110			µs
Max. Thermal Offset Voltage @ 5.0mA Control	0.2			µvolts
Min. Off-State dv/dt	1000			V/µs
Typical Output Capacitance (see figure 10)	6			pF @ 50V

GENERAL CHARACTERISTICS	(PVA2352N, PVA3324N and PVA3354N)	Units
Dielectric Strength: Input-Output	4000	V <sub>RMS</sub>
Insulation Resistance: Input-Output @ 90V <sub>DC</sub>	10 <sup>12</sup> @ 25°C - 50% RH	Ω
Maximum Capacitance: Input-Output	1.0	pF
Max. Pin Soldering Temperature (1.6mm below seating plane, 10 seconds max.)	+260	°C
Ambient Temperature Range:		
Operating	-40 to +85	
Storage	-40 to +100	

International Rectifier does not recommend the use of this product in aerospace, avionics, military or life support applications. Users of this International Rectifier product in such applications assume all risks of such use and indemnify International Rectifier against all damages resulting from such use.

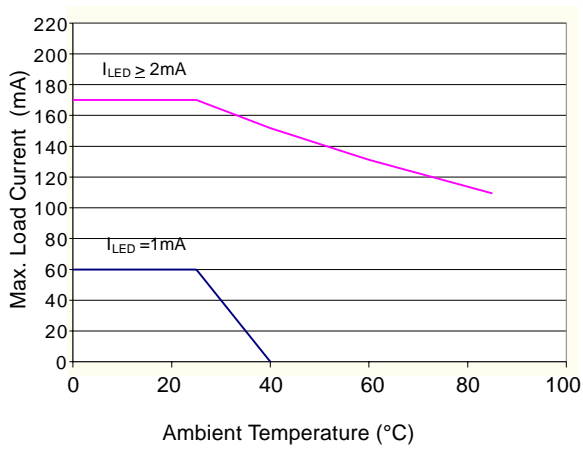

Figure 1. Current Derating Curves (PVA3324N)

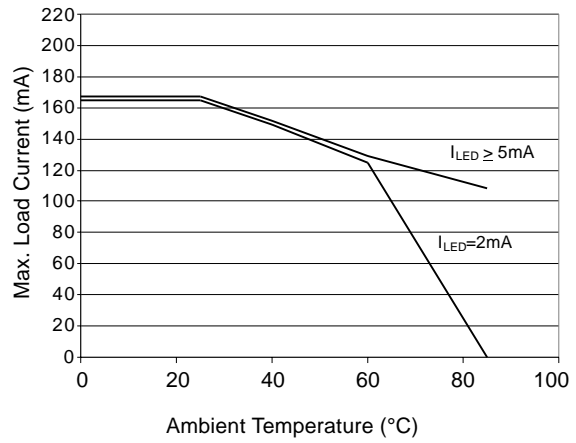

Figure 2. Current Derating Curves (PVA3354N, PVA2352N)

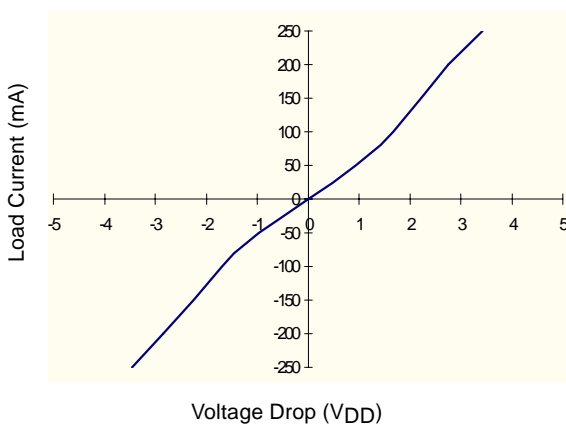

Figure 3. Typical On Characteristics

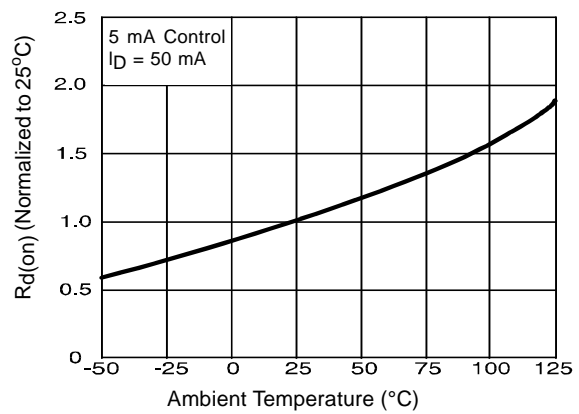

Figure 4. Typical On-Resistance

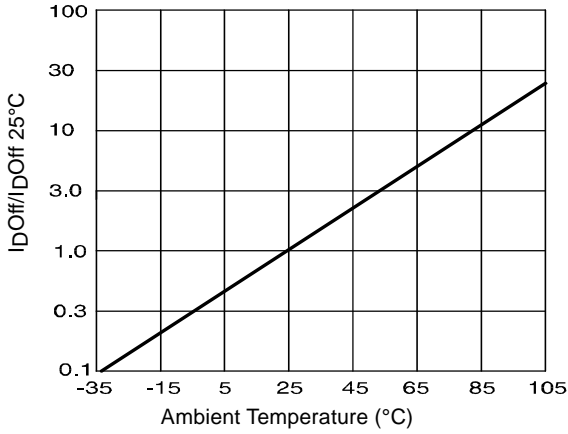

Figure 5. Typical Normalized Off-State Leakage

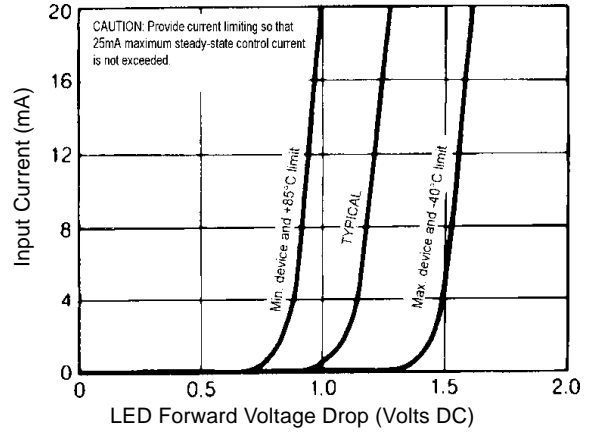

Figure 6. Input Characteristics  
(Current Controlled)

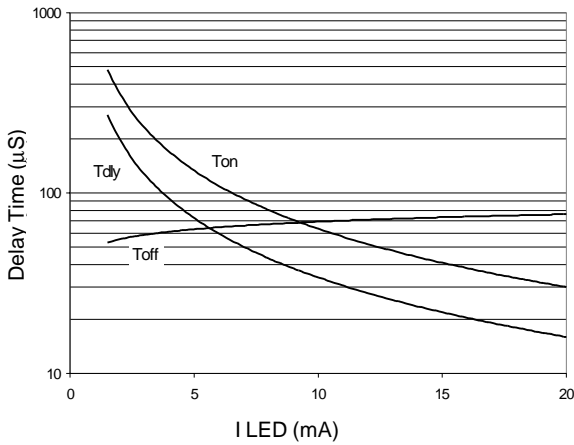

Figure 7. Typical Delay Times

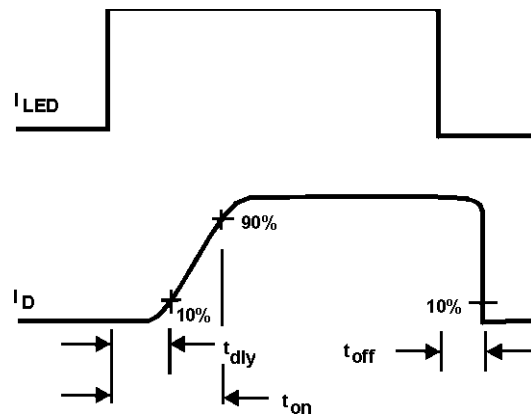

Figure 8. Delay Time Definitions

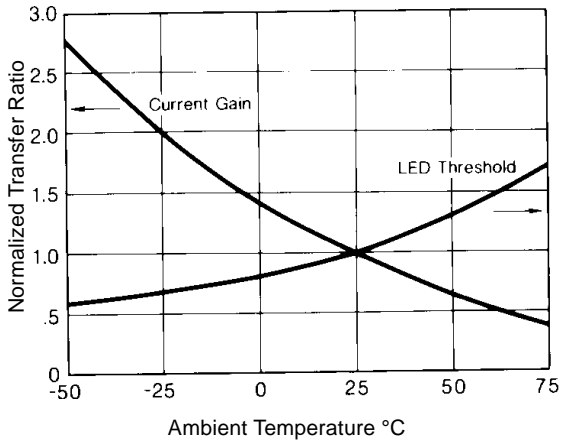

Figure 9. Typical Control Threshold and Transfer Ratio

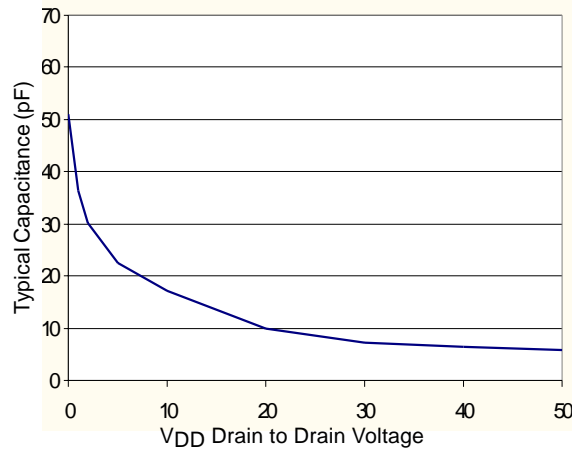
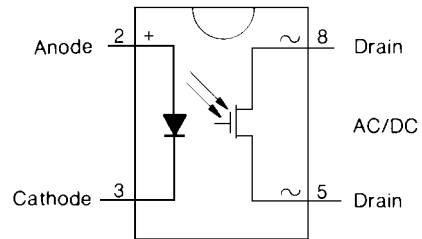

Figure 10. Typical Output Capacitance

## Wiring Diagram



# Series PVA33N

International  
IRF Rectifier

## Case Outlines

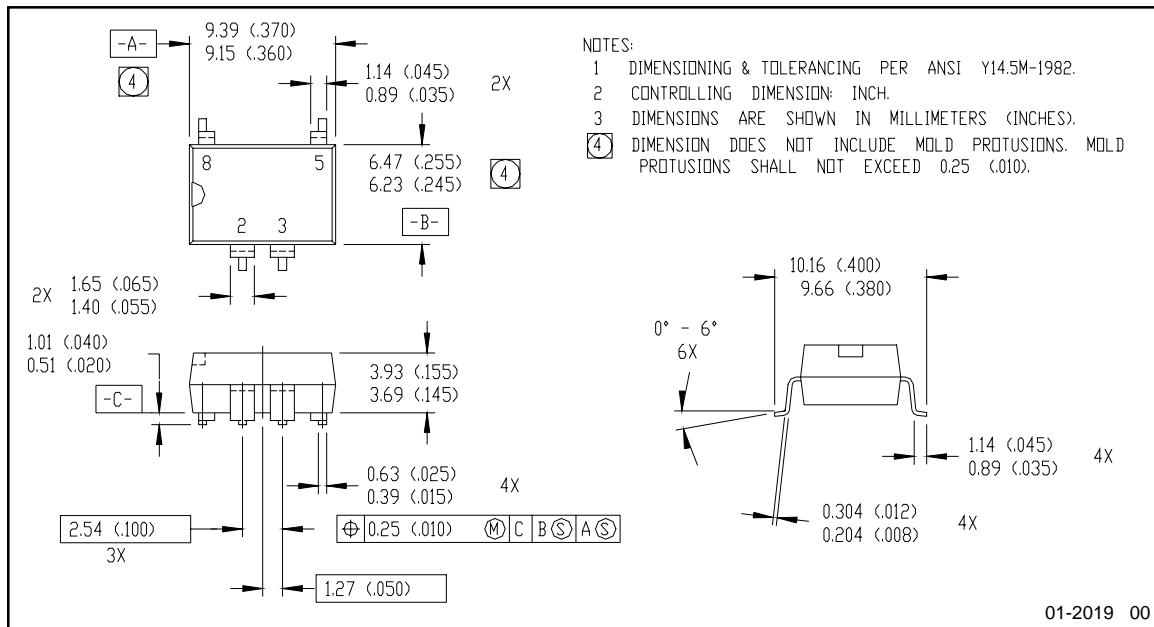
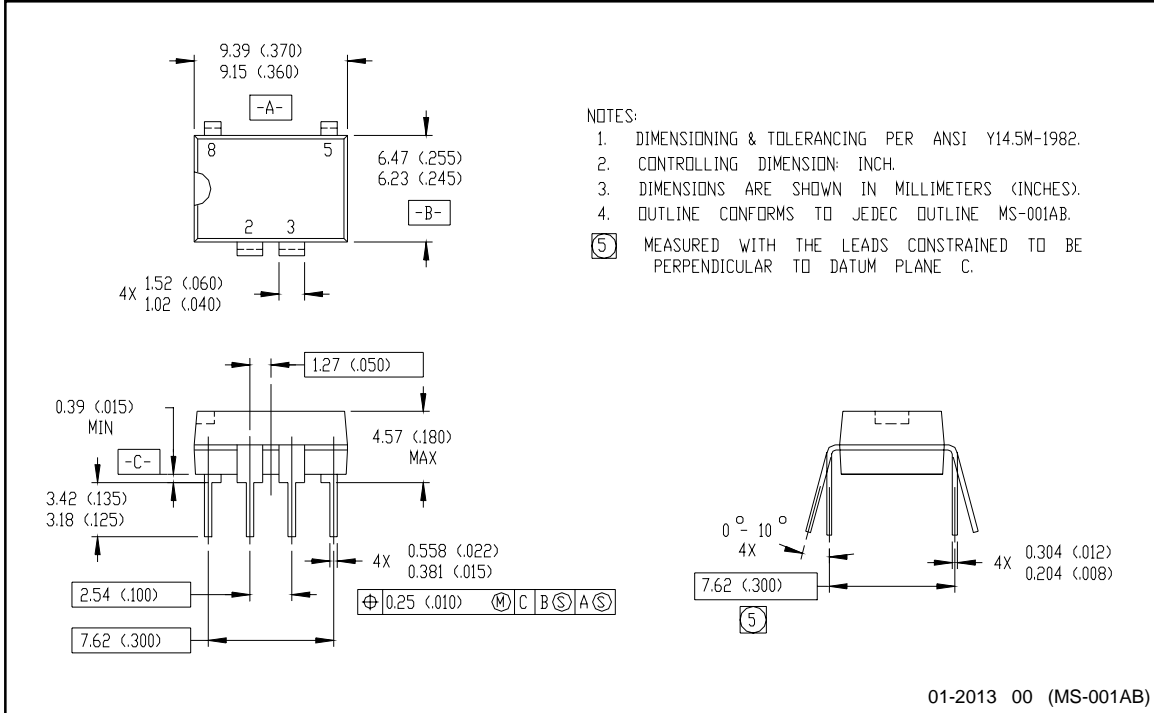

12/11/2003