

Triacs

BT139F series

GENERAL DESCRIPTION

Glass passivated triacs in a full pack, plastic envelope, intended for use in applications requiring high bidirectional transient and blocking voltage capability and high thermal cycling performance. Typical applications include motor control, industrial and domestic lighting, heating and static switching.

QUICK REFERENCE DATA

SYMBOL	PARAMETER	MAX.	MAX.	MAX.	UNIT
V_{DRM}	Repetitive peak off-state voltages	BT139F-500	600	800	V
		BT139F-500F	600F	800F	
		BT139F-500G	600G	800G	
$I_{T(RMS)}$	RMS on-state current	16	16	16	A
I_{TSM}	Non-repetitive peak on-state current	140	140	140	A

PINNING - SOT186

PIN	DESCRIPTION
1	main terminal 1
2	main terminal 2
3	gate
case	isolated

PIN CONFIGURATION

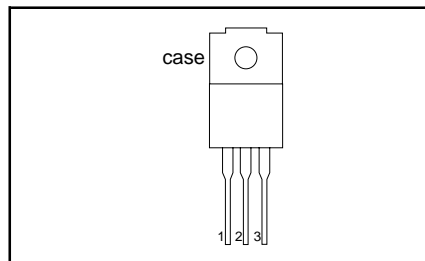

SYMBOL



LIMITING VALUES

Limiting values in accordance with the Absolute Maximum System (IEC 134).

SYMBOL	PARAMETER	CONDITIONS	MIN.	MAX.			UNIT
				-500	-600	-800	
V_{DRM}	Repetitive peak off-state voltages		-	500 ¹	600 ¹	800	V
$I_{T(RMS)}$	RMS on-state current	full sine wave; $T_{hs} \leq 38^\circ C$	-	16			A
I_{TSM}	Non-repetitive peak on-state current	full sine wave; $T_j = 125^\circ C$ prior to surge; with reapplied $V_{DRM(max)}$	-	140			A
I^2t	I^2t for fusing	$t = 20$ ms	-	150			A
di_T/dt	Repetitive rate of rise of on-state current after triggering	$t = 16.7$ ms	-	98			A ² s
		$t = 10$ ms	-	10			A ² s
		$I_{TM} = 20$ A; $I_G = 0.2$ A;					
		$di_G/dt = 0.2$ A/ μ s					
		T2+ G+	-	50			A/ μ s
		T2+ G-	-	50			A/ μ s
		T2- G-	-	50			A/ μ s
		T2- G+	-	10			A/ μ s
I_{GM}	Peak gate current		-	2			A
V_{GM}	Peak gate voltage		-	5			V
P_{GM}	Peak gate power		-	5			W
$P_{G(AV)}$	Average gate power	over any 20 ms period	-	0.5			W
T_{stg}	Storage temperature		-40	150			$^\circ C$
T_j	Operating junction temperature		-	125			$^\circ C$

¹ Although not recommended, off-state voltages up to 800V may be applied without damage, but the triac may switch to the on-state. The rate of rise of current should not exceed 15 A/ μ s.

Triacs

BT139F series

ISOLATION LIMITING VALUE & CHARACTERISTIC $T_{hs} = 25\text{ }^{\circ}\text{C}$ unless otherwise specified

SYMBOL	PARAMETER	CONDITIONS	MIN.	TYP.	MAX.	UNIT
V_{isol}	Repetitive peak voltage from all three terminals to external heatsink	R.H. $\leq 65\%$; clean and dustfree	-		1500	V
C_{isol}	Capacitance from T2 to external heatsink	$f = 1\text{ MHz}$	-	12	-	pF

THERMAL RESISTANCES

SYMBOL	PARAMETER	CONDITIONS	MIN.	TYP.	MAX.	UNIT
$R_{th\ j-hs}$	Thermal resistance junction to heatsink	full or half cycle with heatsink compound	-	-	4.0	K/W
$R_{th\ j-a}$	Thermal resistance junction to ambient	without heatsink compound in free air	-	55	5.5	K/W

STATIC CHARACTERISTICS $T_j = 25\text{ }^{\circ}\text{C}$ unless otherwise stated

SYMBOL	PARAMETER	CONDITIONS	MIN.	TYP.	MAX.			UNIT
I_{GT}	Gate trigger current	BT139F- $V_D = 12\text{ V}; I_T = 0.1\text{ A}$		F	...G	
		T2+ G+	-	5	35	25	50	mA
		T2+ G-	-	8	35	25	50	mA
		T2- G-	-	10	35	25	50	mA
		T2- G+	-	22	70	70	100	mA
I_L	Latching current	$V_D = 12\text{ V}; I_{GT} = 0.1\text{ A}$						
		T2+ G+	-	7	40	40	60	mA
		T2+ G-	-	20	60	60	90	mA
		T2- G-	-	8	40	40	60	mA
		T2- G+	-	10	60	60	90	mA
I_H	Holding current	$V_D = 12\text{ V}; I_{GT} = 0.1\text{ A}$	-	6	30	30	60	mA
V_T	On-state voltage	$I_T = 20\text{ A}$	-	1.2	1.6			V
V_{GT}	Gate trigger voltage	$V_D = 12\text{ V}; I_T = 0.1\text{ A}$	-	0.7	1.5			V
		$V_D = 400\text{ V}; I_T = 0.1\text{ A};$ $T_j = 125\text{ }^{\circ}\text{C}$	0.25	0.4	-			V
I_D	Off-state leakage current	$V_D = V_{DRM(max)};$ $T_j = 125\text{ }^{\circ}\text{C}$	-	0.1	0.5			mA

Triacs

BT139F series

DYNAMIC CHARACTERISTICS $T_j = 25\text{ °C}$ unless otherwise stated

SYMBOL	PARAMETER	CONDITIONS	MIN.			TYP.	MAX.	UNIT
		F	...G			
dV_D/dt	Critical rate of rise of off-state voltage	BT139F- $V_{DM} = 67\% V_{DRM(max)}$; $T_j = 125\text{ °C}$; exponential waveform; gate open circuit	100	50	200	250	-	V/ μ s
dV_{com}/dt	Critical rate of change of commutating voltage	$V_{DM} = 400\text{ V}$; $T_j = 95\text{ °C}$; $I_{T(RMS)} = 16\text{ A}$; $dl_{com}/dt = 7.2\text{ A/ms}$; gate open circuit	-	-	10	20	-	V/ μ s
t_{gt}	Gate controlled turn-on time	$I_{TM} = 20\text{ A}$; $V_D = V_{DRM(max)}$; $I_G = 0.1\text{ A}$; $dl_G/dt = 5\text{ A}/\mu$ s	-	-	-	2	-	μ s

Triacs

BT139F series

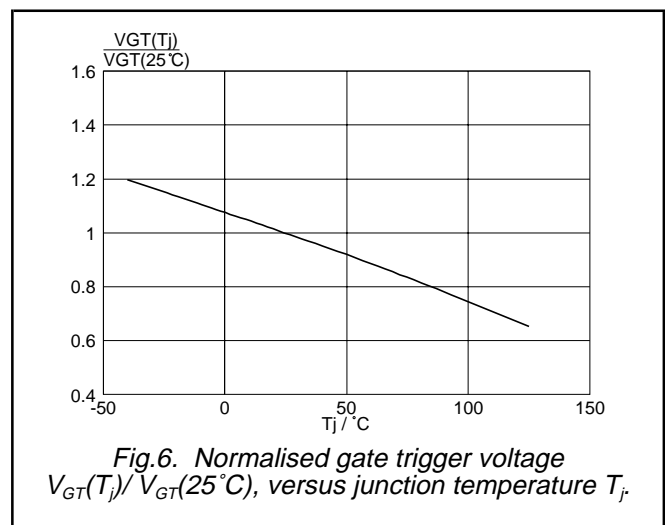
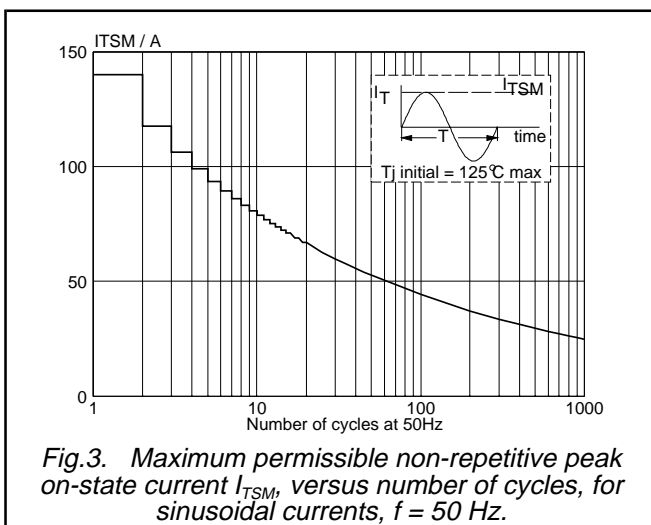
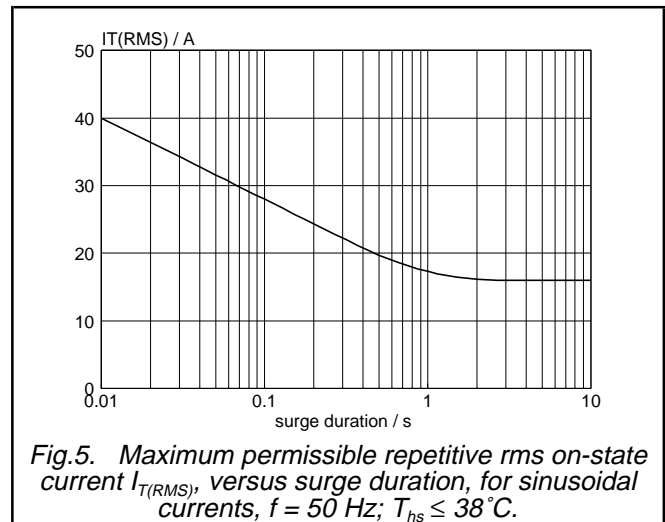
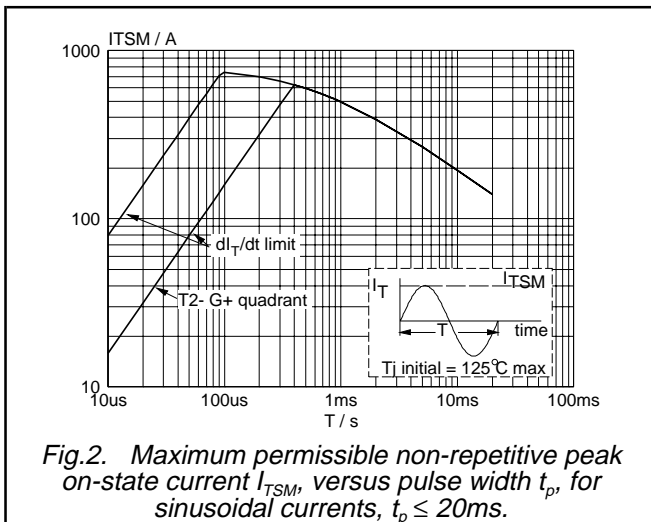
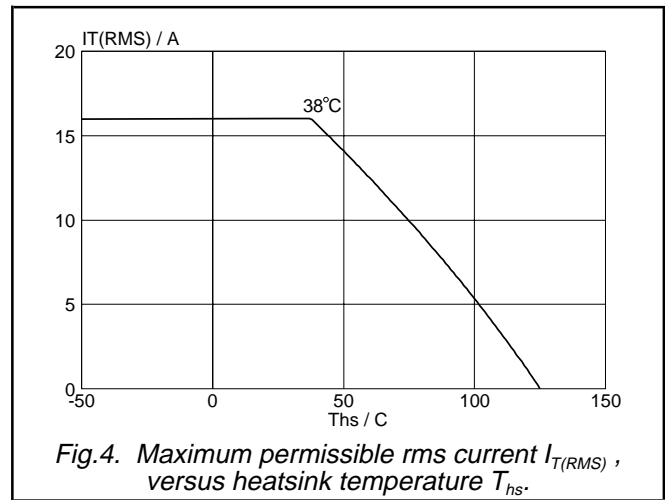
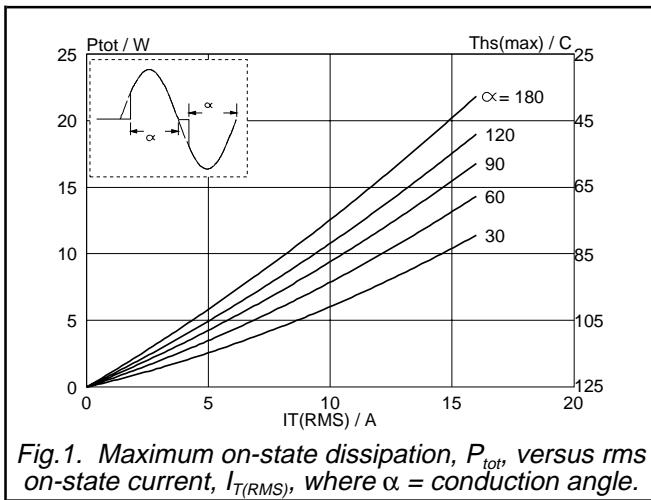

Triacs

BT139F series

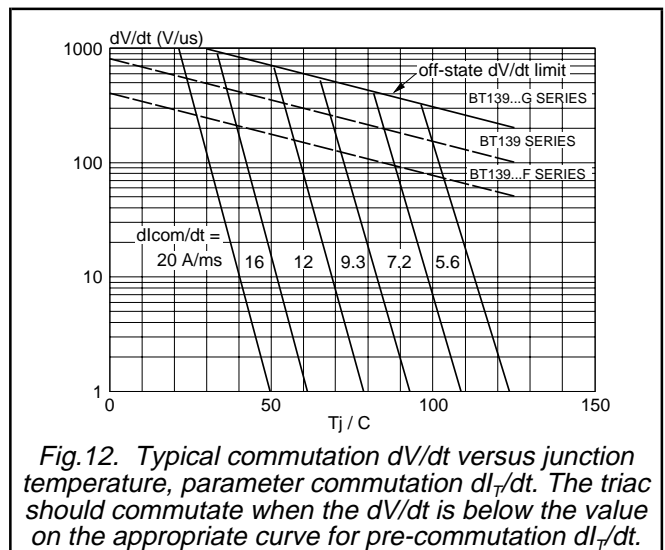
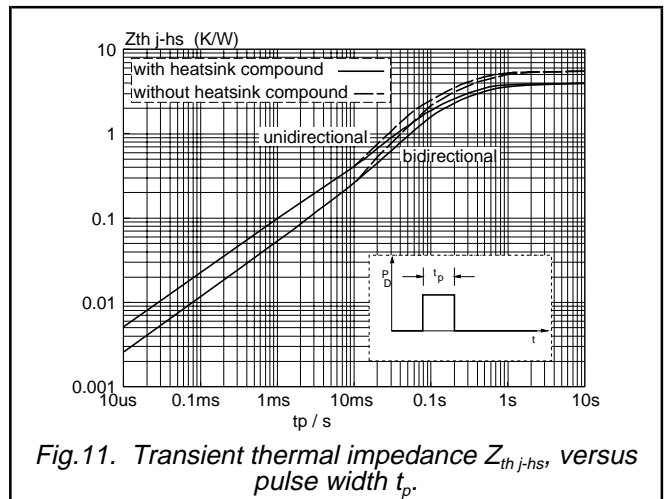
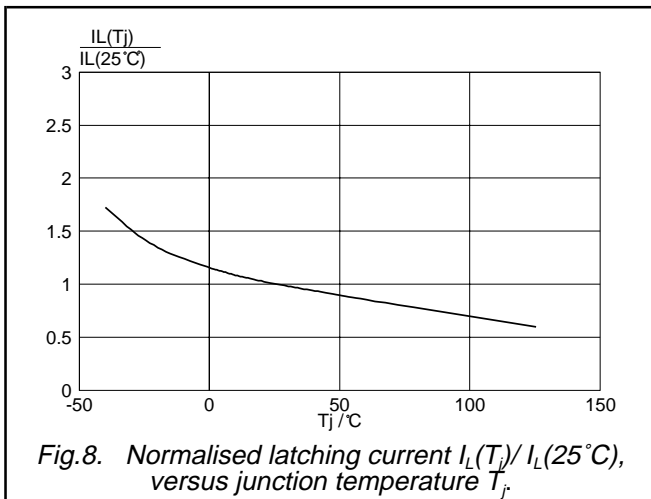
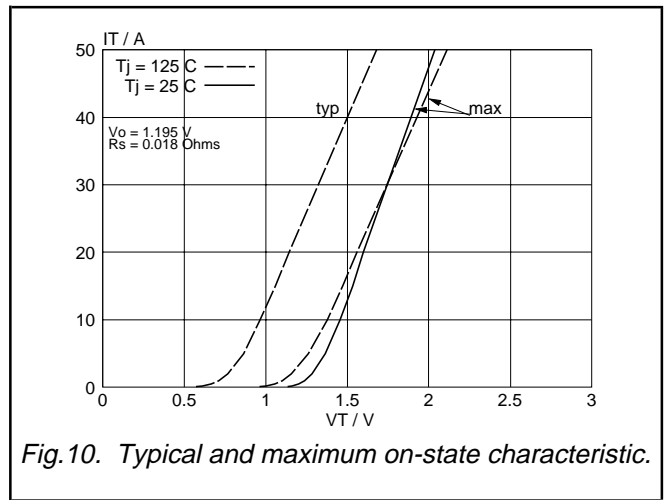
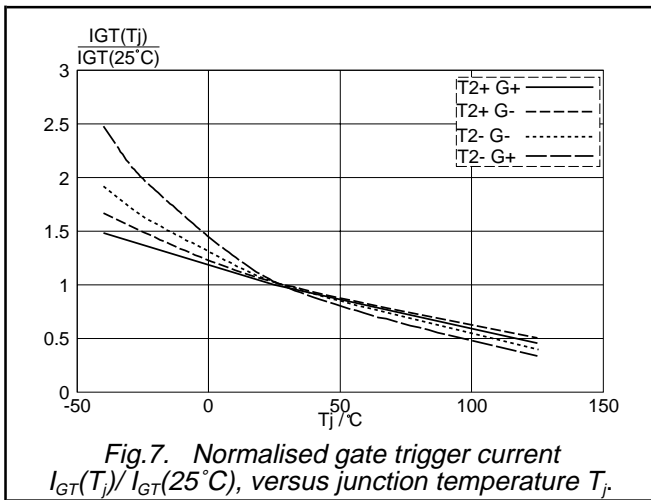

Triacs

BT139F series

MECHANICAL DATA

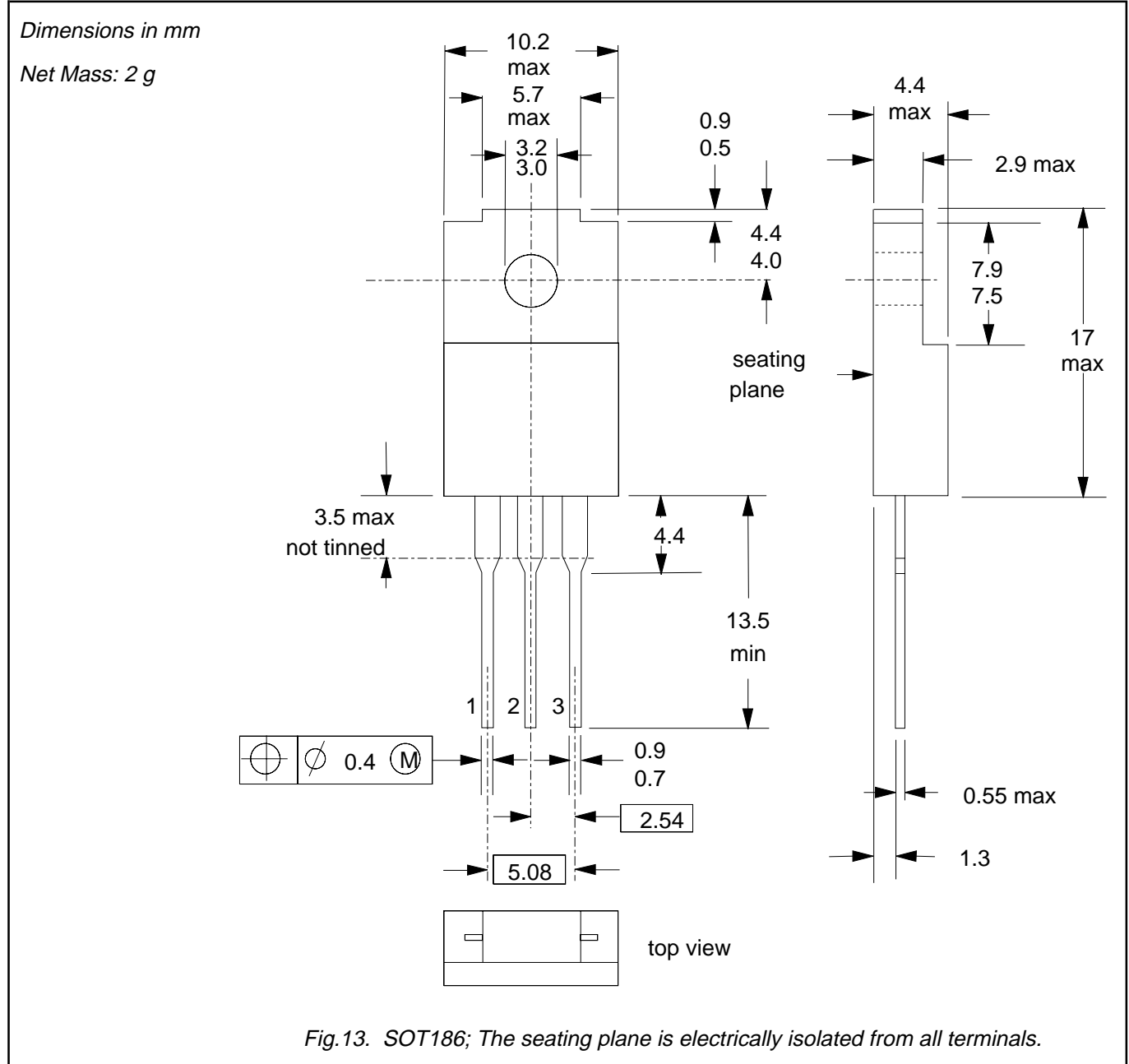

Notes

- 1. Accessories supplied on request: refer to mounting instructions for F-pack envelopes.
- 2. Epoxy meets UL94 V0 at 1/8".

Triacs

BT139F series

DEFINITIONS

Data sheet status	
Objective specification	This data sheet contains target or goal specifications for product development.
Preliminary specification	This data sheet contains preliminary data; supplementary data may be published later.
Product specification	This data sheet contains final product specifications.
Limiting values	
Limiting values are given in accordance with the Absolute Maximum Rating System (IEC 134). Stress above one or more of the limiting values may cause permanent damage to the device. These are stress ratings only and operation of the device at these or at any other conditions above those given in the Characteristics sections of this specification is not implied. Exposure to limiting values for extended periods may affect device reliability.	
Application information	
Where application information is given, it is advisory and does not form part of the specification.	
© Philips Electronics N.V. 1996	
All rights are reserved. Reproduction in whole or in part is prohibited without the prior written consent of the copyright owner.	
The information presented in this document does not form part of any quotation or contract, it is believed to be accurate and reliable and may be changed without notice. No liability will be accepted by the publisher for any consequence of its use. Publication thereof does not convey nor imply any license under patent or other industrial or intellectual property rights.	

LIFE SUPPORT APPLICATIONS

These products are not designed for use in life support appliances, devices or systems where malfunction of these products can be reasonably expected to result in personal injury. Philips customers using or selling these products for use in such applications do so at their own risk and agree to fully indemnify Philips for any damages resulting from such improper use or sale.