

PC906

DC Input Type OPIC Photocoupler with Built-in ON/OFF Delay Circuit

■ Features

1. Propagation delay time
(t_{PHL} , t_{PLH} : TYP. 0.75ms)
2. High noise resistance type
(CM_H , CM_L : TYP. 2kV/ μ s)
3. High sensitivity
(I_{FLH} : MAX. 1.5 mA)
4. Bi-directional input, 4-channel type

■ Applications

1. Programmable controllers

■ Outline Dimensions

(Unit : mm)

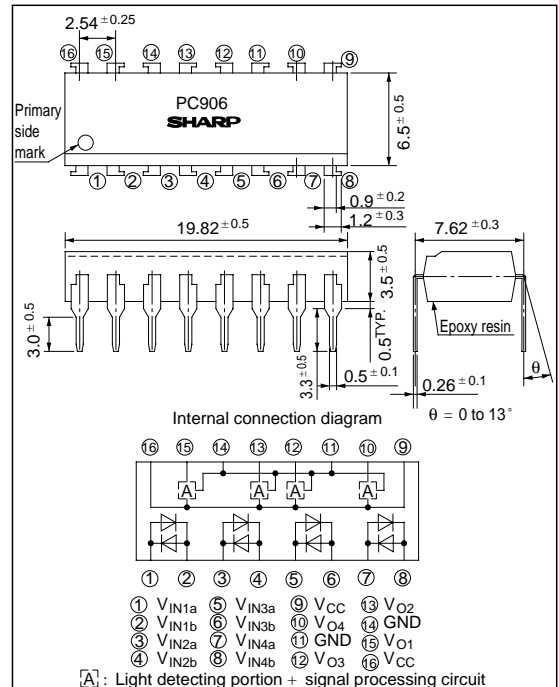

* "OPIC" (Optical IC) is a trademark of the SHARP Corporation.
An OPIC consists of a light-detecting element and signal-processing circuit integrated onto a single chip.

■ Absolute Maximum Ratings

(Ta = 25°C)

Parameter		Symbol	Ratings	Unit
Input	*1 Forward current	I_F	± 26	mA
	*1, *2 Peak forward current	I_{FM}	± 1	A
	*1 Power dissipation	P	40	mW
Output	Supply voltage	V_{CC}	7	V
	*1, *4 Output voltage	V_O	7	V
	*1 Output current	I_O	4	mA
	*3 Power dissipation	P_O	200	mW
	*5 Isolation voltage	V_{iso}	4 000	V_{rms}
	Operating temperature	T_{opr}	- 25 to + 85	°C
Storage temperature	T_{stg}	- 55 to + 125	°C	
*6 Soldering temperature	T_{sol}	260	°C	

*1 Each channel

*2 Pulse width $\leq 100 \mu$ s, Duty ratio : 0.001

*3 All channel

*4 Shall not exceed from supply voltage (V_{CC}).

*5 40 to 60% RH, AC for 1min.

*6 For 10 seconds

■ Electro-optical Characteristics

(Shows characteristics value I_{ch} at $V_{cc} = 5V$, $T_a = 25^\circ C$, unless otherwise specified)

Parameter		Symbol	Conditions	MIN.	TYP.	MAX.	Unit	Fig.		
Input	Forward voltage	V_F	$I_F = \pm 10mA$	-	1.2	1.4	V	-		
	Terminal capacitance	C_t	$V_F = 0, f = 1MHz$	-	30	250	pF			
Output	Operating supply voltage	V_{cc}		4.5	-	5.5	V	1		
	Low level output voltage	V_{OL}	$I_F = 0mA, I_{OL} = 1.6mA$	-	0.1	0.4	V			
	High level output voltage	V_{OH}	$I_F = \pm 4mA$	3.5	-	-	V			
	Output short-circuit current	I_{OS}	$I_F = \pm 4mA$	- 0.75	- 0.45	- 0.25	mA			
	^{*7} Low level supply current	I_{CCL}	$I_F = 0mA$	-	18	30	mA		4	
	^{*7} High level supply current	I_{CCH}	$I_F = \pm 4mA$	-	16	28	mA			
	^{*8} Power supply noise induction “Output high level”	$PSNI_H$	$R_L = 4.0k\Omega, I_F = \pm 4mA$ $f_{AC} = 100kHz$	0.5	-	-	Vp - p		5	
	^{*9} Power supply noise induction “Output low level”	$PSNI_L$	$R_L = 4.0k\Omega, I_F = 0mA$ $f_{AC} = 100kHz$	0.5	-	-	Vp - p			
	Transfer characteristics	“Low→High” threshold input current 1		$R_L = 4.0k\Omega$	-	0.7	1.5		mA	6
“Low→High” threshold input current 2		I_{FLH2}	-		- 0.7	- 1.5	mA			
^{*7} Isolation resistance		R_{ISO}	DC500V, 40 to 60% RH	5×10^{10}	1×10^{11}	-	Ω	-		
Response time		“Low→High” propagation time		$I_F = \pm 4mA$ $R_L = 4.0k\Omega$	-	0.75	1.35	ms	7	
		“High→Low” propagation time			t_{PHL}	-	0.75	1.35		ms
		Rise time			t_r	-	0.3	0.7		μs
		Fall time			t_f	-	0.05	0.4		μs
Instantaneous common mode rejection voltage (High level output)		CM_H	$R_L = 4.0k\Omega, I_F = \pm 4mA$ $V_{CM} = 600V$ (peak) V_O (MIN.) = 2.0V	-	- 2 000	-	V/ μs	8		
Instantaneous common mode rejection voltage (Low level output)		CM_L	$R_L = 4.0k\Omega, I_F = 0mA$ $V_{CM} = 600V$ (peak) V_O (MAX.) = 0.8V	-	2 000	-	V/ μs			
^{*10} Input terminal noise-proof		SNI_F	$R_L = 4k\Omega$	10	-	-	mA	9		

*7 All channel

*8 Maximum “Peak to peak” voltage of sine wave to keep $V_O > 3.5V$ when it is superposed 100kHz sine wave to V_{cc} .

*9 Maximum “Peak to peak” voltage of sine wave to keep $V_O \leq 4.0V$ when it is superposed 100kHz sine wave to V_{cc} .

*10 Maximum value which V_O can keep 0.4V MAX. when it inputs the pulse, I_F (1 cycle : 1ms and pulse width : 1 μs).

■ Test circuit

Fig. 1

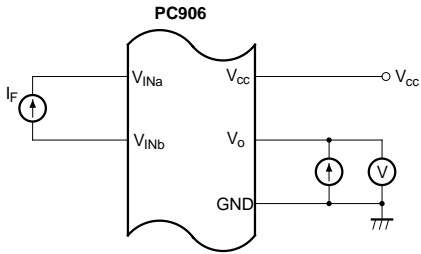

Fig. 2

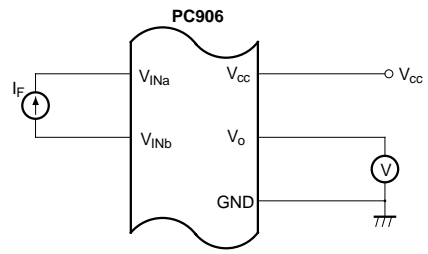

Fig. 3

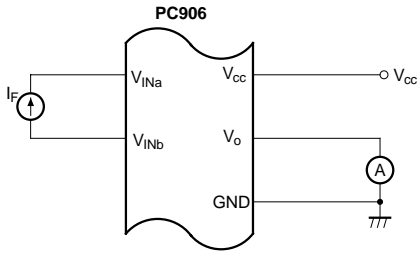

Fig. 4

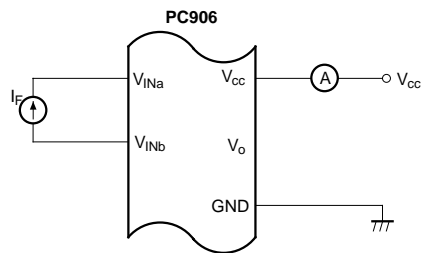

Fig. 5

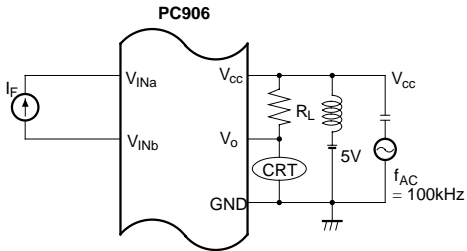
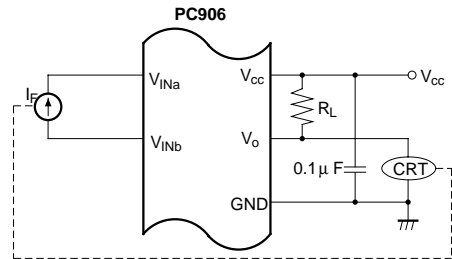

Fig. 6



It measures the I_F when output changes from "Low level" to "High level".

Fig. 7

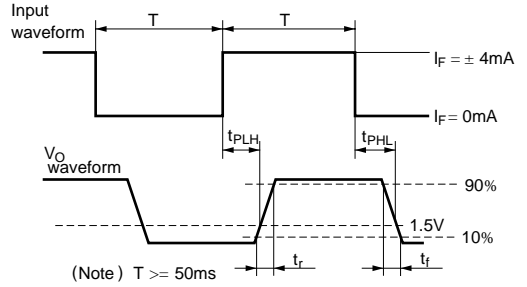
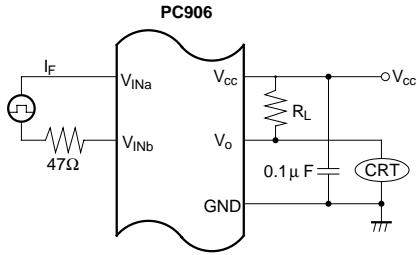

Fig. 8

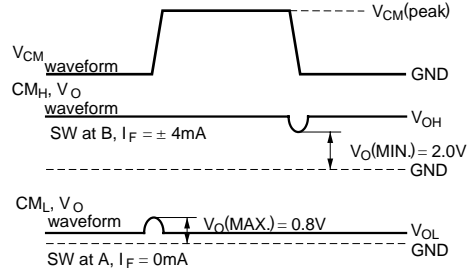
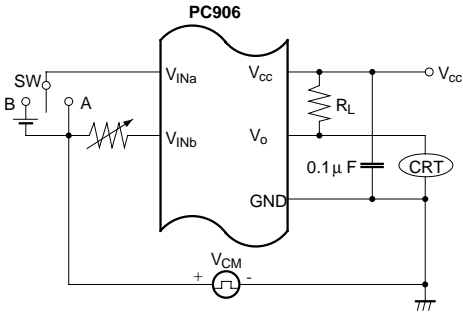
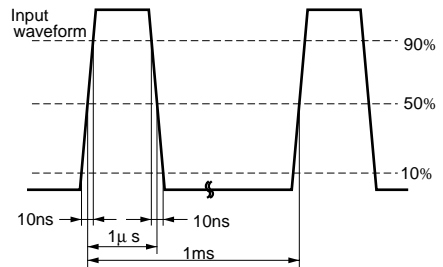
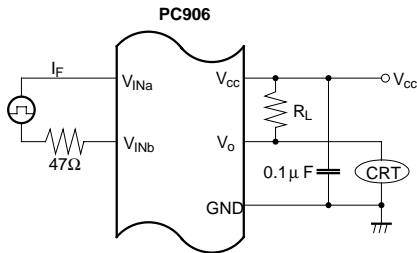

Fig. 9



Internal Equivalent Circuit Diagram (1ch.)

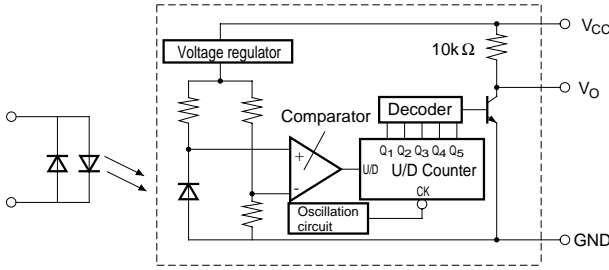

Fig. 1 Forward Current vs. Ambient Temperature

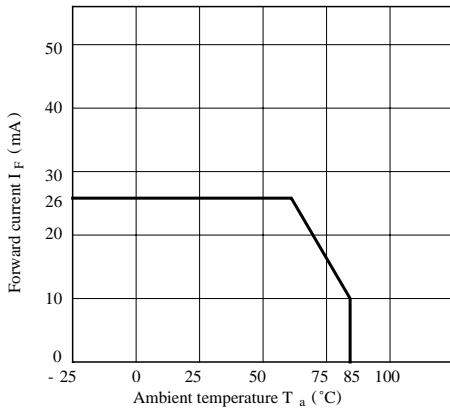

Fig. 2 Supply Current vs. Ambient Temperature

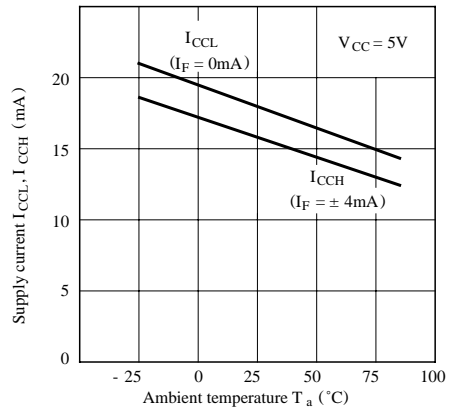

Fig. 3 Low Level Output Voltage vs. Ambient Temperature

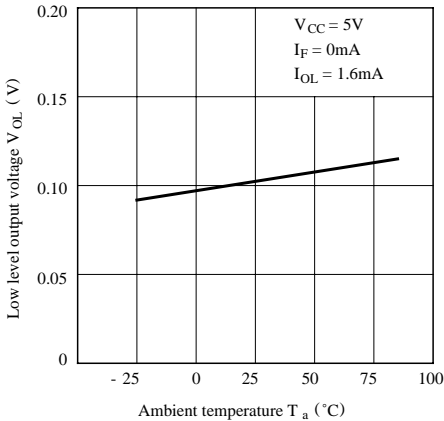

Fig. 4 Relative Threshold Input Current vs. Ambient Temperature

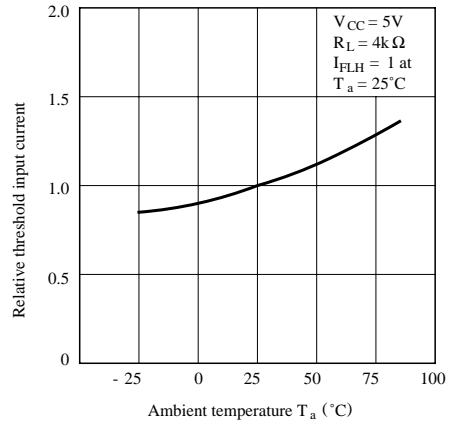

Fig. 5 Propagation Delay Time vs. Forward Current

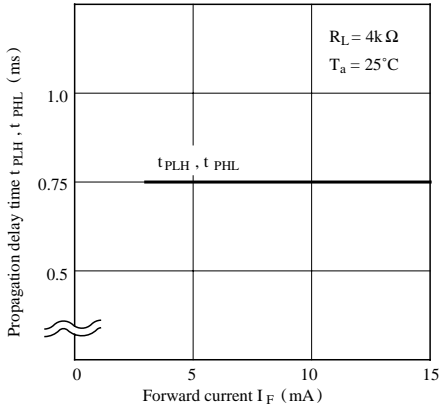

Fig. 6 Propagation Delay Time vs. Ambient Temperature

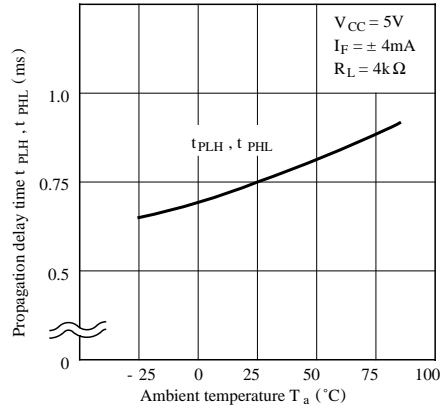

Fig. 7 Output Short-circuit Current vs. Ambient Temperature

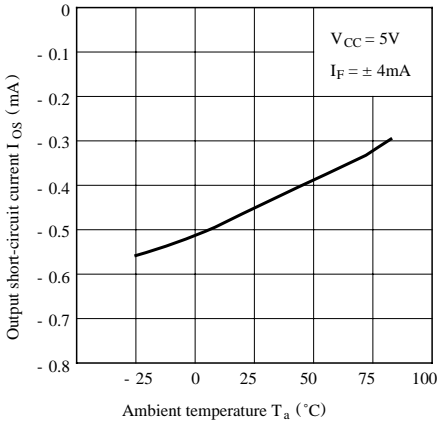

Fig. 8 Rise Time, Fall Time vs. Load Resistance

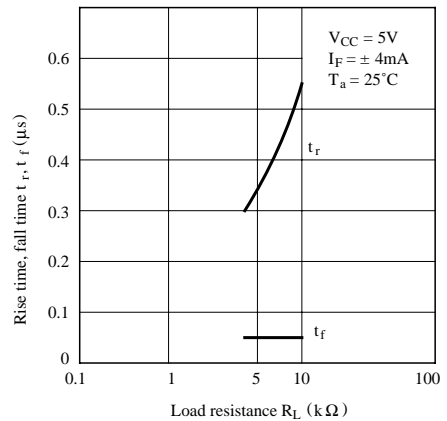

Fig. 9-a Supply Voltage/Output Voltage vs. Time (1)

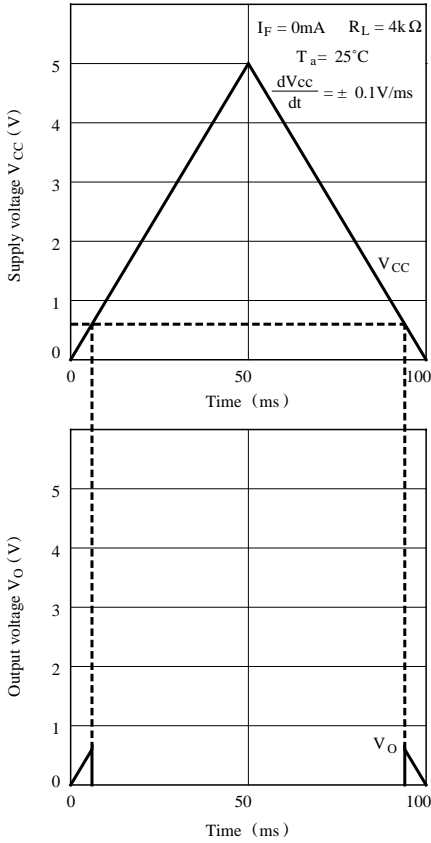
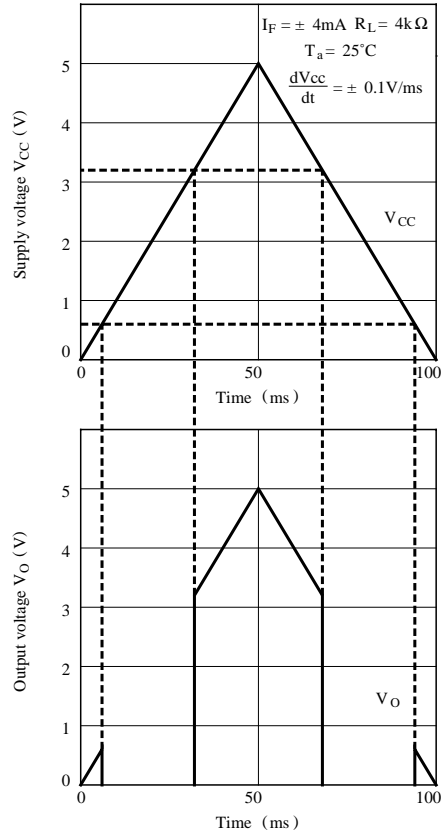

Fig. 9-b Supply Voltage/Output Voltage vs. Time (2)



● Please refer to the chapter “Precautions for Use”.