

SANYO

No.917D



LA6324

Monolithic Linear IC
HIGH-PERFORMANCE QUAD OPERATIONAL AMP

The LA6324 consists of four independent, high-performance, internally phase compensated operational amplifiers that are designed to operate from a single power supply over a wide range of voltages. These four operational amplifiers are packaged in a single package. As in case of conventional general-purpose operational amplifiers, operation from dual power supplies is also possible and the power dissipation is low.

It can be applied to various uses in commercial and industrial equipment including all types of transducer amplifiers, DC amplifiers.

FEATURES

- Phase compensation not required.
- Wide operation power supply voltage: 3.0 ~ 30.0 V (single supply)
±1.5 ~ ±15.0 V (dual supplies)
- Input voltage includes the neighborhood of GND level; output voltage V_{out} is from 0 to $V_{CC}-1.5$ V.
- Low current dissipation; $I_{CC}=0.6$ mA typ/ $R_L=\infty$

MAXIMUM RATINGS/ $T_a = 25^\circ\text{C}$

			unit
Maximum supply voltage	V_{CC}	32	V
Differential input voltage	V_{ID}	32	V
Maximum input voltage	V_{IN} max	-0.3 ~ +32	V
Allowable power dissipation	P_d max	720	mW
Operating temperature	T_{opg}	-30 ~ +85	$^\circ\text{C}$
Storage temperature	T_{stg}	-55 ~ +125	$^\circ\text{C}$

OPERATING CHARACTERISTICS/ $T_a = 25^\circ\text{C}, V_{CC} = +5$ V

		Test circuit	min	typ	max	unit
Input offset voltage	V_{IO}	1		±2	±7	mV
Input offset current	I_{IO}	2		±5	±50	nA
Input bias current	I_B	3		45	250	nA
Common-mode input voltage range	V_{ICM}	4	0		$V_{CC}-1.5$	V
Common-mode rejection ratio	CMR	4	65	80		dB
Large amplitude voltage gain	VG	5	25	100		V/mV
Output voltage range	V_{OUT}		0		$V_{CC}-1.5$	V
Power supply rejection ratio	SVR	6	65	100		dB
Channel separation		7		120		dB
Current dissipation	I_{CC}	8		0.6	2	mA
	I_{CC}			1.5	3	mA
Output current (source)	I_{O} source	9	20	40		mA
Output current (sink)	I_{O} sink	10	10	20		mA

Equivalent circuit (1 unit)

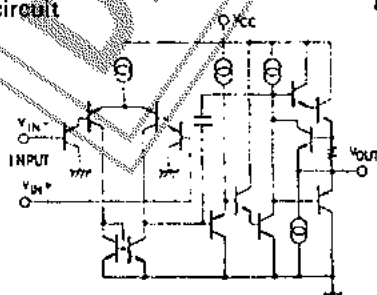

Pin Assignment

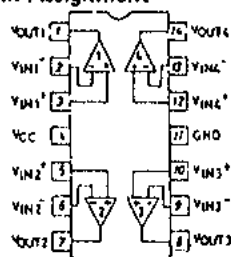

Case Outline 3003A-D141C (unit:mm)

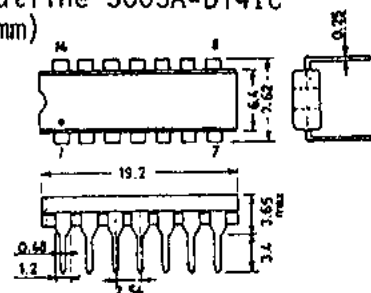

Specifications and information herein are subject to change without notice.

SANYO Electric Co., Ltd. Semiconductor Overseas Marketing Div.
Natsume Bldg. 18-6, 2-chome, Yushima, Bunkyo-ku, TOKYO 113 JAPAN

Test Circuits

1 Input offset voltage V_{IO}

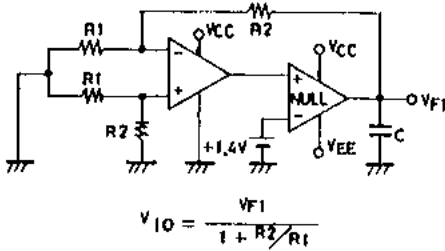

2 Input offset current I_{IO}

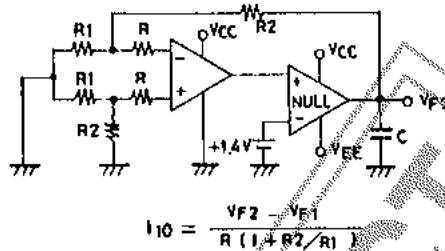

3 Input bias current I_B

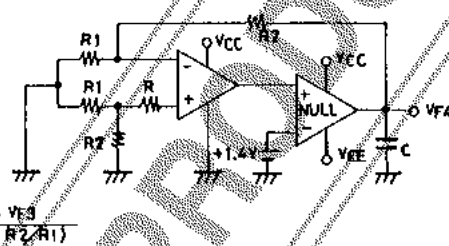
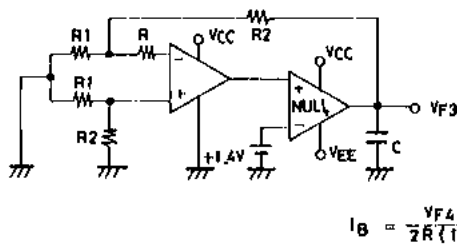

4 Common-mode rejection ratio CMR
Common-mode input voltage range V_{ICM}

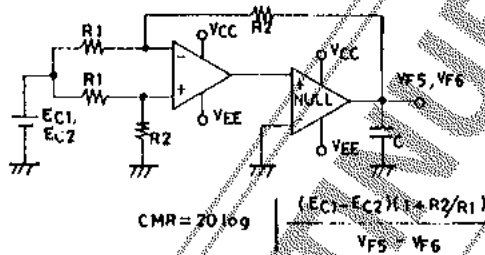

5 Voltage gain V_G

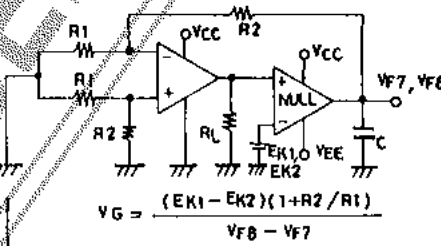

6 Power supply rejection ratio SVR

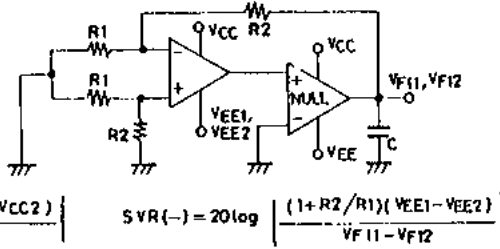
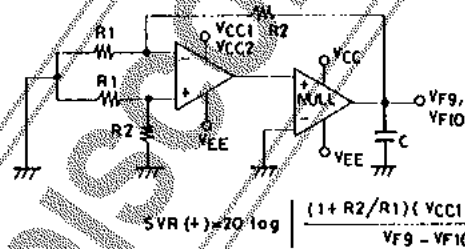

7 Channel separation CS

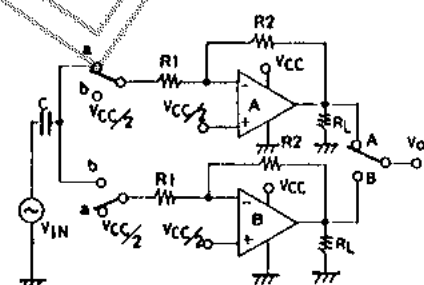

SW: a

$$CS(A \rightarrow B) = 20 \log \frac{R2 \cdot V_{OA}}{R1 \cdot V_{OB}}$$

SW: b

$$CS(B \rightarrow A) = 20 \log \frac{R2 \cdot V_{OB}}{R1 \cdot V_{OA}}$$

These apply also to other channels.

8 Current dissipation I_{CC}

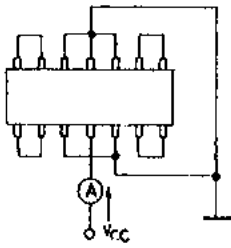

9 Output current I_O source

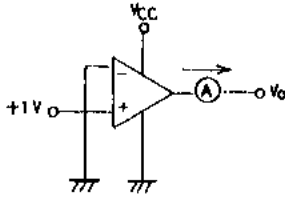

10 Output current I_O sink

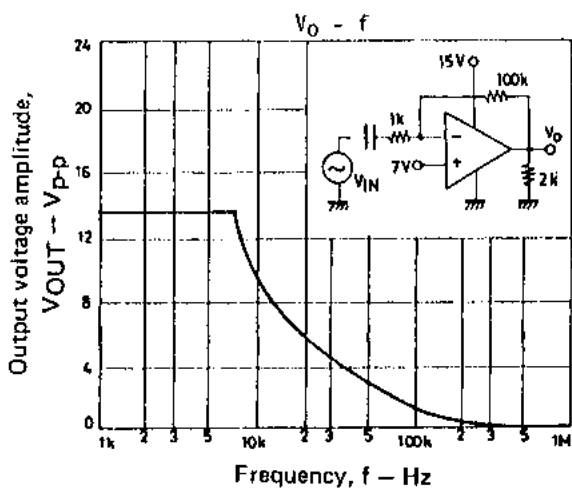
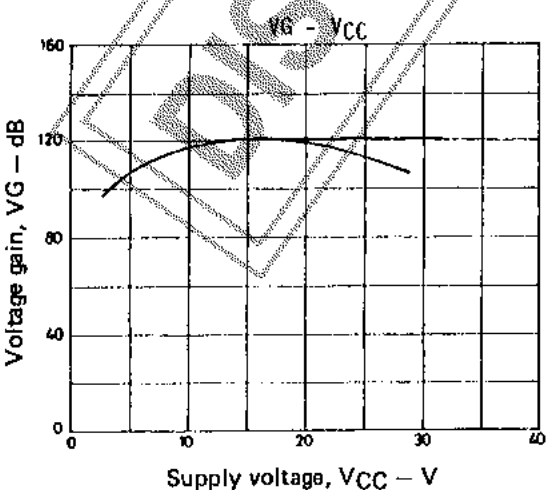
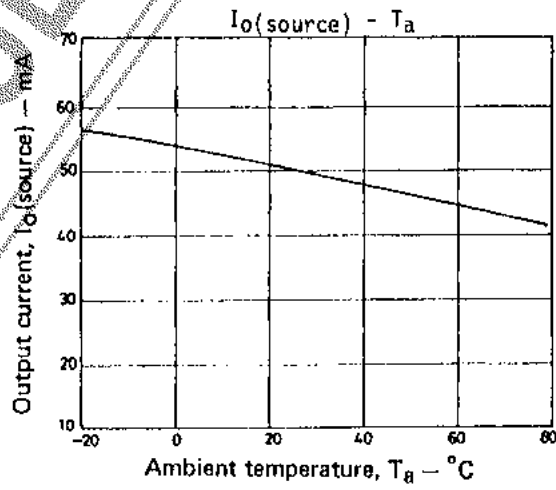
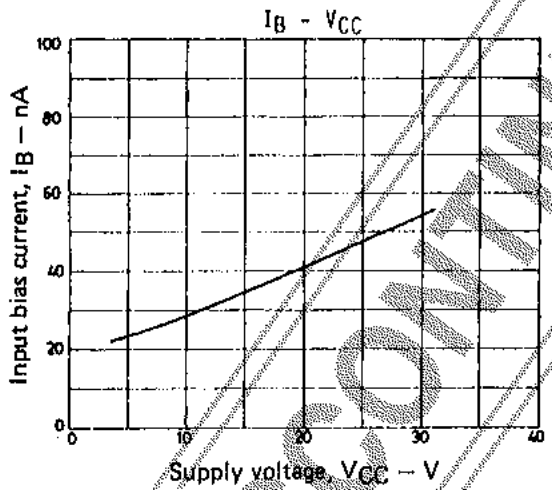
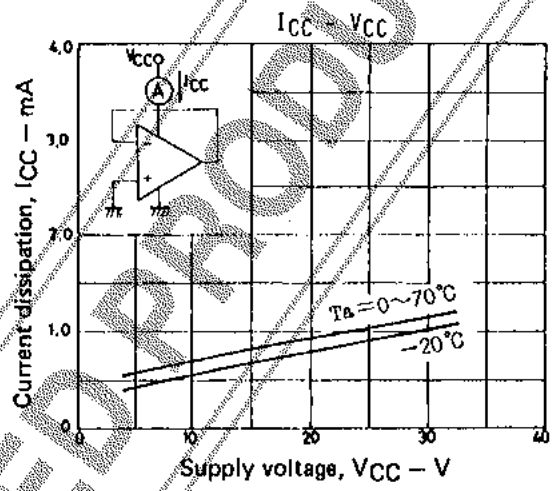
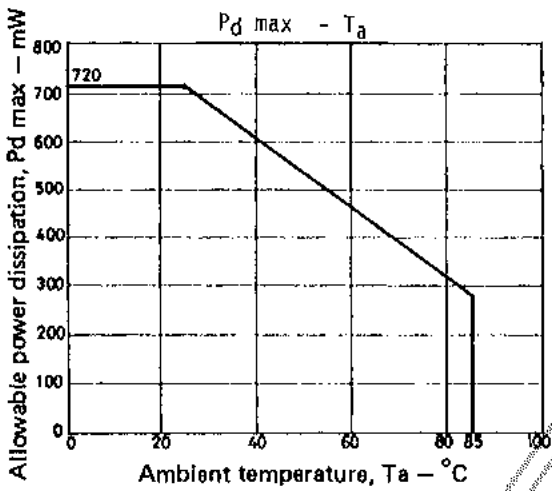
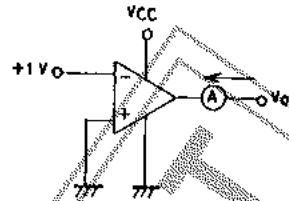

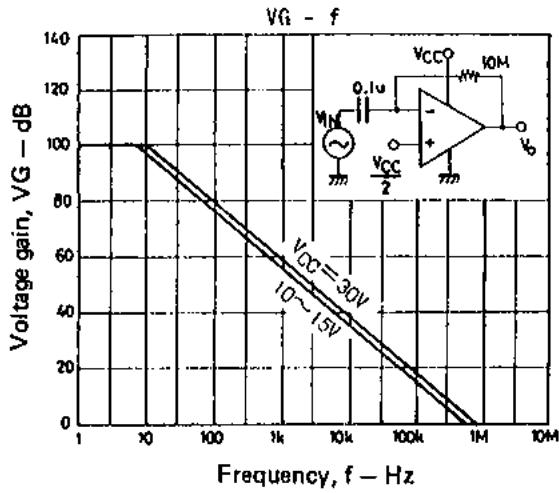

Sample Application Circuits

Non-inverting DC amplifier

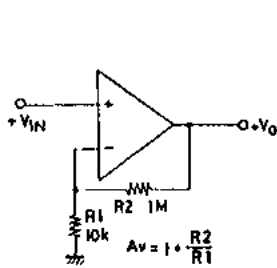

Inverting AC amplifier

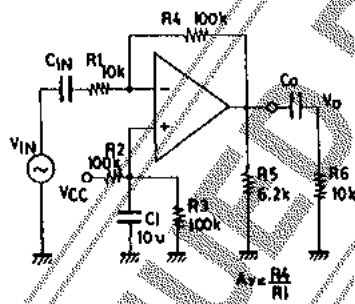

Square wave oscillator

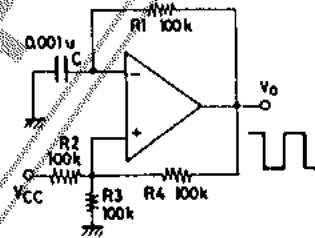

Information furnished by SANYO is believed to be accurate and reliable. However, no responsibility is assumed by SANYO for its use; nor for any infringements of patents or other rights of third parties which may result from its use, and no license is granted by implication or otherwise under any patent or patent rights of SANYO.