

# The MRFIC Line

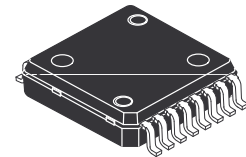
## 1800 MHz GaAs Integrated Power Amplifier

Designed specifically for application in Pan European digital 1.0 watt DCS1800/PCS1900 handheld radios, the MRFIC1817 is specified for 32 dBm output power with power gain over 27 dB from a 3.6 volt supply. To achieve this superior performance, Motorola's planar GaAs MESFET process is employed. The device is packaged in the PFP-16 Power Flat Package which gives excellent thermal and electrical performance through a solderable backside contact while allowing the convenience and cost benefits of reflow soldering.

- Minimum Output Power Capabilities
  - 32 dBm @ 3.6 Volts
  - 30 dBm @ 3.0 Volts
- Typical Volt Characteristics
  - RF Input Power = 5.0 dBm
  - RF Output Power = 33.5 dBm
  - Typical PAE = 42%
- Low Current required from Negative Supply – 2 mA max
- Guaranteed Stability and Ruggedness
- Order MRFIC1817R2 for Tape and Reel.  
R2 Suffix = 1,500 Units per 16 mm, 13 inch Reel.
- Device Marking = M1817

# MRFIC1817

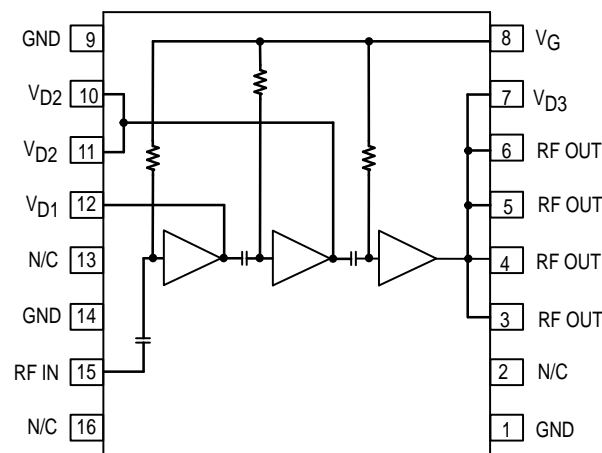
1700–1900 MHz MMIC  
DCS1800/PCS1900  
INTEGRATED POWER AMPLIFIER  
GaAs MONOLITHIC  
INTEGRATED CIRCUIT



CASE 978-02  
(PFP-16)

### ABSOLUTE MAXIMUM RATINGS ( $T_A = 25^\circ\text{C}$ , $Z_O = 50 \Omega$ , unless otherwise noted)

Rating	Symbol	Value	Unit
DC Positive Supply Voltage	$V_{D1, 2, 3}$	6	Vdc
DC Negative Supply Voltage	VSS	-5	Vdc
RF Input Power	$P_{in}$	10	dBm
RF Output Power	$P_{out}$	35	dBm
Operating Case Temperature Range	$T_C$	-35 to +85	$^\circ\text{C}$
Storage Temperature Range	$T_{stg}$	-55 to +150	$^\circ\text{C}$
Thermal Resistance, Junction to Case	$R_{\theta JC}$	10	$^\circ\text{C/W}$



Pin Connections and Functional Block Diagram

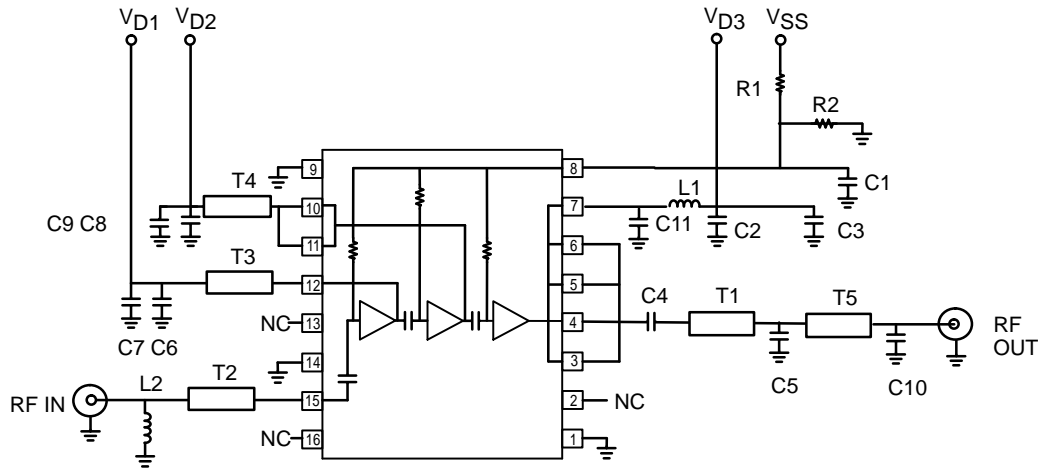
## RECOMMENDED OPERATING RANGES

Parameter	Symbol	Value	Unit
Supply Voltage	$V_{D1, 2, 3}$	2.7 to 5	Vdc
Gate Voltage	$V_{SS}$	-3.5 to -4.5	Vdc
RF Frequency Range	$f_{RF}$	1700 to 1900	MHz
RF Input Power	$P_{RF}$	0 to 6	dBm

**ELECTRICAL CHARACTERISTICS** ( $V_{D1, 2, 3} = 3.6$  V,  $V_{SS} = -4$  V,  $P_{in} = 5$  dBm, Peak Measurement at 12.5% Duty Cycle, 4.6 ms Period,  $T_A = 25^\circ\text{C}$  unless otherwise noted. Measured in Reference Circuit Shown in Figure 1)

Characteristic	Min	Typ	Max	Unit
Frequency Range	1710	—	1785	MHz
Output Power	32	33.5	—	dBm
Power Added Efficiency	35	42	—	%
Output Power (PCS 1900 Tuning $f = 1850$ to $1910$ MHz)	—	33.5	—	dBm
Power Added Efficiency (PCS 1900 Tuning $f = 1850$ to $1910$ MHz)	—	42	—	%
Input VSWR	—	2:1	—	VSWR
Harmonic Output (2nd and 3rd)	—	-35	-30	dBc
Output Power at Low voltage ( $V_{D1}, V_{D2}, V_{D3} = 3.0$ V)	30	32	—	dBm
Output Power Isolation ( $V_{D1}, V_{D2}, V_{D3} = 0$ V)	—	-40	-30	dBm
Noise Power (In 100 kHz, 1805 to 1880 MHz)	—	-85	-80	dBm
Stability – Spurious Output ( $P_{in} = 5$ dBm, $P_{out} = 0$ to 33 dBm, Load VSWR = 6:1 at any Phase Angle, Source VSWR = 3:1, at any Phase Angle) (1)	—	—	-60	dBc
Load Mismatch stress ( $P_{out} = 33$ dBm, Load VSWR = 10:1 at any Phase Angle) (1)	No Degradation in Output Power after Returning to Standard Conditions			
3 dB $V_{DD}$ Bandwidth	—	2	—	MHz
Negative Supply Current	—	0.7	2	mA

(1) Adjust  $V_{D1, 2, 3}$  (0 to 3.6 V) for specified  $P_{out}$ ; Duty Cycle = 12.5%, Period = 4.6 ms.



C1	1 nF	L1	18 nH, Coilcraft or 20 mm	T2	6 mm 50 $\Omega$ Microstrip Line
C2, C6, C8	22 pF, NPO/COG		50 $\Omega$ Microstrip Line	T3	5 mm 40 $\Omega$ Microstrip Line
C3, C7, C9	47 nF	L2	1.8 nH, Toko 2012	T4	1 mm 40 $\Omega$ Microstrip Line
C4	5.6 pF, AVX0603 ACCUF	R1	2.7 K $\Omega$	T5	5.5 mm 50 $\Omega$ Microstrip Line
C5	3.9 pF, AVX0603 ACCUF	R2	2.2 K $\Omega$		
C10, C11	1 pF	T1	2.5 mm 50 $\Omega$ Microstrip Line		

Board Material: Glass/Epoxy,  $\epsilon_r = 4.45$ , Thickness = 0.5 mm

NOTE: For PCS 1900 tuning the following values are changed.

C5 = 2.7 pF, AVX0603 ACCUF

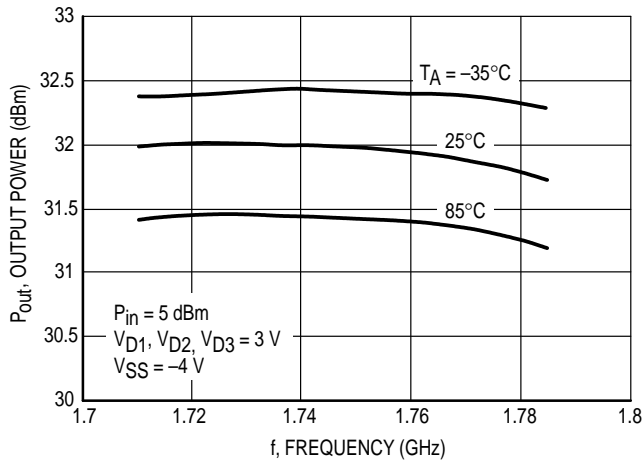
L2 = 1.5 nH, Toko 2012

T3 = 1 mm 50  $\Omega$  Microstrip Line

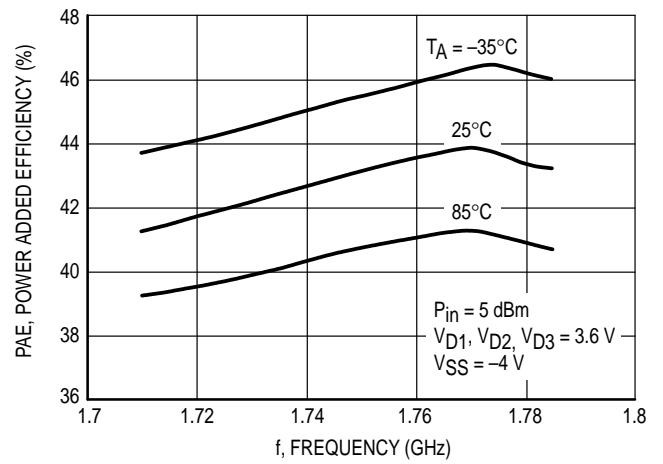
**Figure 1. Reference Circuit Configuration**



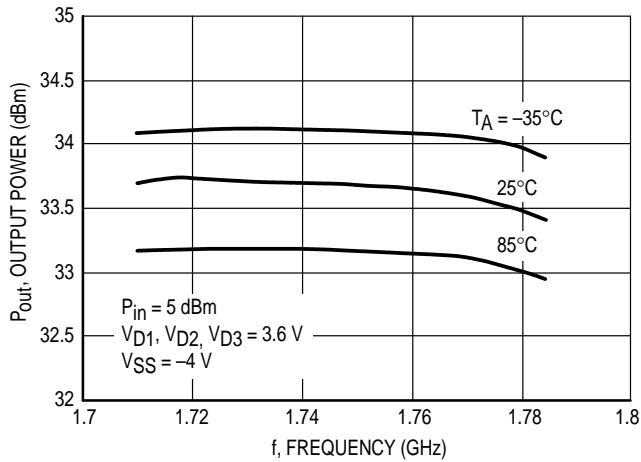
## Typical Characteristics



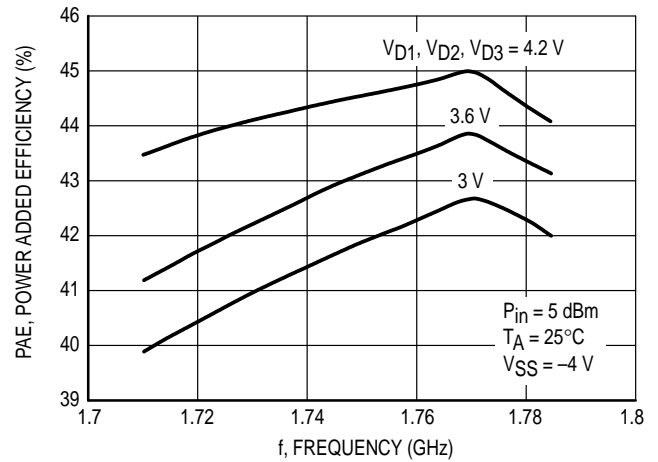
**Figure 3. Output Power versus Frequency**



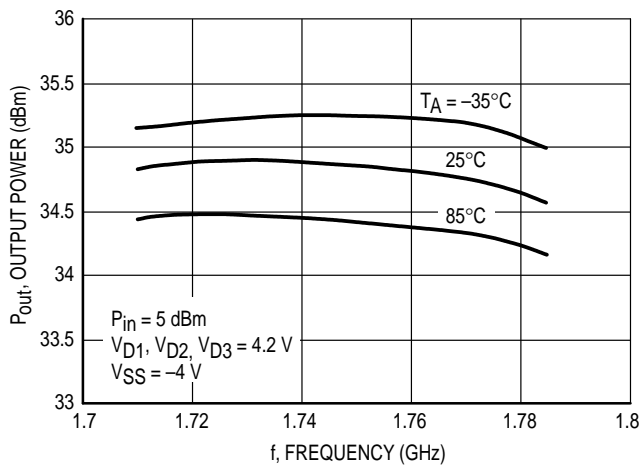
**Figure 4. Power Added Efficiency versus Frequency**



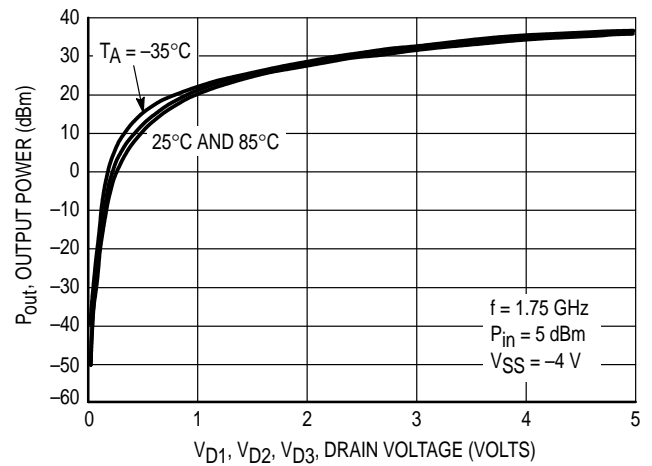
**Figure 5. Output Power versus Frequency**



**Figure 6. Power Added Efficiency versus Frequency**

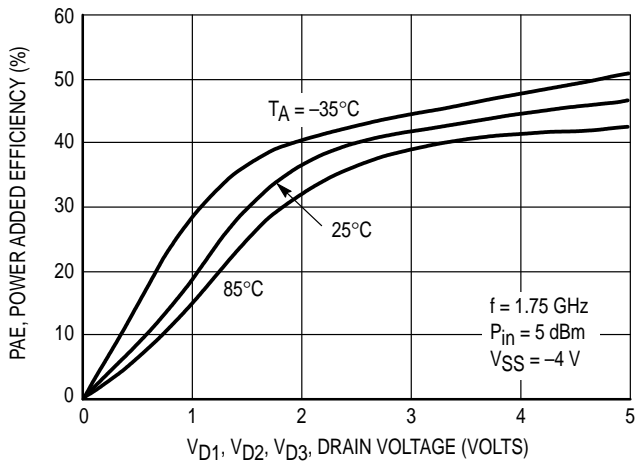


**Figure 7. Output Power versus Frequency**

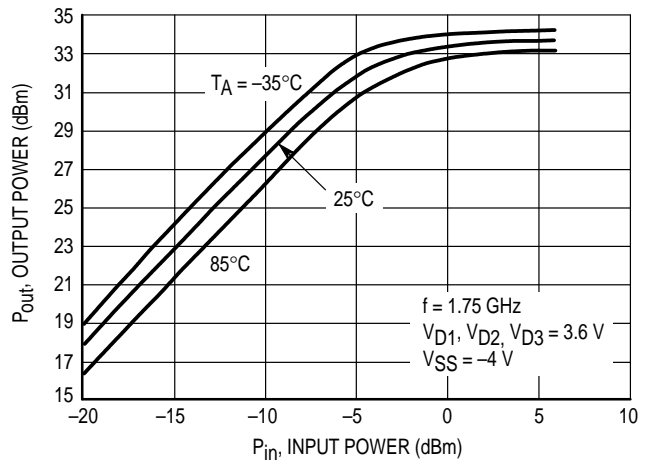


**Figure 8. Output Power versus Drain Voltage**

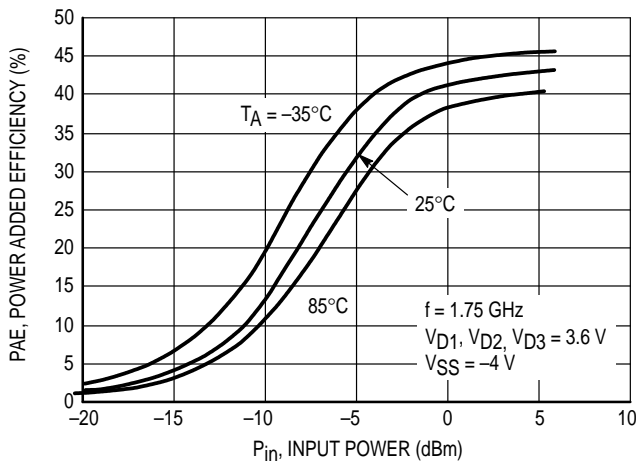
## Typical Characteristics



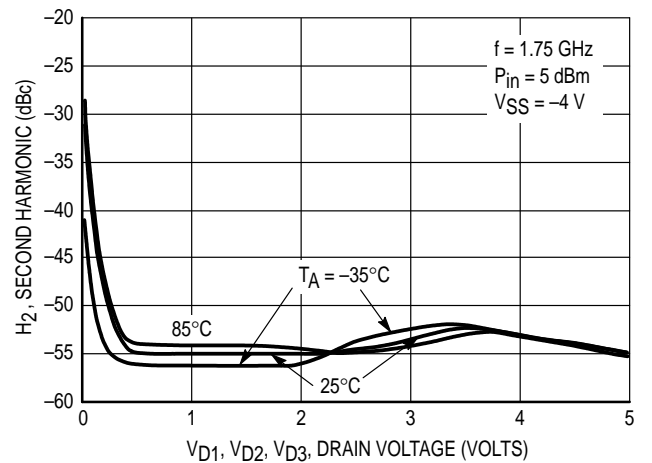
**Figure 9. Power Added Efficiency versus Drain Voltage**



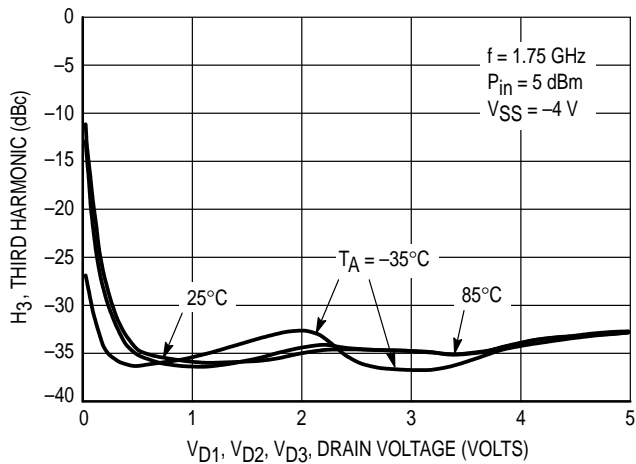
**Figure 10. Output Power versus Input Power**



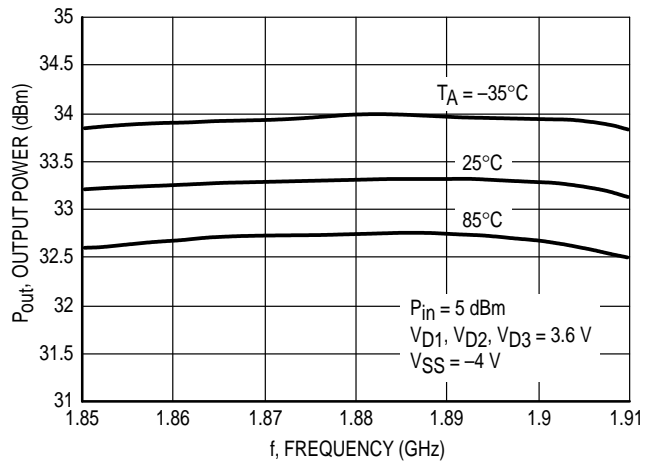
**Figure 11. Power Added Efficiency versus Input Power**



**Figure 12. Second Harmonic versus Drain Voltage**

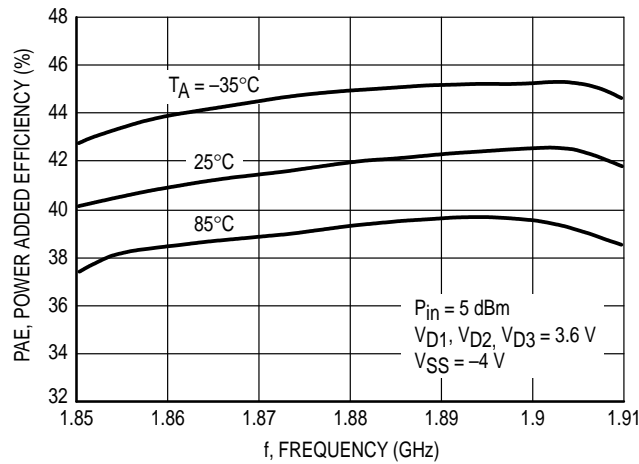


**Figure 13. Third Harmonic versus Drain Voltage**



**Figure 14. Output Power versus Frequency - PCS Band**

## Typical Characteristics



**Figure 15. Power Added Efficiency versus Frequency – PCS Band**

**Table 1. Optimum Loads Derived from Circuit Characterization**

f MHz	Z <sub>in</sub> OHMS		Z <sub>OL</sub> <sup>*</sup> OHMS	
	R	jX	R	jX
1710	7.77	-34.15	4.89	9.50
1720	7.84	-34.37	4.87	9.34
1730	7.87	-34.67	4.86	9.18
1740	8.07	-34.79	4.78	8.94
1750	8.24	-35.05	4.77	8.70
1760	8.39	-35.22	4.73	8.51
1770	8.44	-35.56	4.70	8.32
1780	8.52	-35.79	4.67	8.12
1785	8.57	-35.82	4.65	7.95

Z<sub>in</sub> represents the input impedance of the device.  
Z<sub>OL</sub><sup>\*</sup> represents the conjugate of the optimum output load to present to the device.

**Table 2. Optimum Loads Derived from Circuit Characterization – PCS Band**

f MHz	Z <sub>in</sub> OHMS		Z <sub>OL</sub> <sup>*</sup> OHMS	
	R	jX	R	jX
1850	3.97	-39.68	7.49	3.07
1860	3.94	-40.31	7.42	2.81
1870	4.09	-40.65	7.38	2.51
1880	4.04	-40.92	7.31	2.28
1890	4.18	-41.21	7.28	2.02
1900	4.27	-41.48	7.28	1.73
1910	4.26	-41.71	7.23	1.56

Z<sub>in</sub> represents the input impedance of the device.  
Z<sub>OL</sub><sup>\*</sup> represents the conjugate of the optimum output load to present to the device.

## APPLICATIONS INFORMATION

### Design Philosophy

The MRFIC1817 is a 3-stage integrated power amplifier designed for use in cellular phones, especially for those used in DCS1800 (PCN) 3.6 V operation. With matching circuit modifications, it is also applicable for use in DCS1900 (PCS) equipment. Due to the fact that the input, output and some of the interstage matching is accomplished off-chip, the device can be tuned to operate anywhere within the 1500 to 2000 MHz frequency range. Typical performance at different battery voltages is:

- 33.5 dBm @ 3.6 V
- 32.0 dBm @ 3 V

This capability makes the MRFIC1817 suitable for portable cellular applications such as:

- 3 V and 3.6 V DCS1800 Class I and II
- 3 V and 3.6 V PCS tag5

### RF Circuit Considerations

The MRFIC1817 can be tuned by changing the values and/or positions of the appropriate external components. Refer to Figure 2, a typical DCS1800 Class I applications circuit. The input match is a shunt-L, series-C, high-pass structure and can be retuned as desired with the only limitation being the on-chip 6 pF blocking capacitor. For saturated applications such as DCS1800 and PCS1900, the input match should be optimized at the rated RF input power. Interstage matching can be optimized by changing the value and/or position of the decoupling capacitor on the  $V_{D1}$  and  $V_{D2}$  supply lines. Moving the capacitor closer to the device or reducing the value increases the frequency of resonance with the inductance of the device's wirebonds and leadframe pin. Output matching is accomplished with a low-pass network as a compromise between bandwidth and harmonic rejection. Implementation is through high Q capacitors mounted along a 50  $\Omega$  microstrip transmission line. Values and positions are chosen to present a 2 W loadline to the device while conjugating the device output parasitics. The network must also properly terminate the second and third harmonics to optimize efficiency and reduce harmonic output. All components used in this application are low-Q commercial chip capacitors, except for the output load line. Loss in circuit traces must also be considered. The output transmission line and the bias supply lines should be at least 0.6 mm in width to accommodate the peak circulating currents which can be as high as 2 amperes under worst case conditions. The bias supply line which supplies the output should include an RF choke of at least 18 nH, surface mount solenoid inductors or quarter wave microstrip lines. Discrete inductors will usually give better efficiency and conserve board space.

### Biasing Considerations

Gate bias lines are tied together and connected to the  $V_{SS}$  voltage, allowing gate biasing through use of external resistors or positive voltages. This allows setting the quiescent current of all stage in the same time while saving some board space. For applications where the amplifier is operated close to saturation, such as with TDMA amplifiers, the gate bias can be set with resistors. Variations in process

and temperature will not affect amplifier performance significantly in these applications. The values shown in the Figure 1 will set quiescent currents of 20 to 40 mA for the first stage, 150 to 300 mA for the second stage, and 400 to 800 mA for the final stage. For linear modes of operation which are required for CDMA amplifiers, the quiescent current must be more carefully controlled. For these applications, the  $V_G$  pins can be referenced to some tunable voltage which is set at the time of radio manufacturing. Less than 1 mA is required in the divider network so a DAC can be used as the voltage source.

### Power Control Using the MC33169

The MC33169 is a dedicated GaAs power amplifier support IC which provides the  $-4$  V required for  $V_{SS}$ , an N-MOS drain switch interface and driver and power supply sequencing. The MC33169 can be used for power control in applications where the amplifier is operated in saturation since the output power in non-linear operation is proportional to  $V_{D2}$ . This provides a very linear and repeatable power control transfer function. This technique can be used open loop to achieve 40–45 dB dynamic range over process and temperature variation. With careful design and selection of calibration points, this technique can be used for DCS1800 control where 30 dB dynamic range is required, eliminating the need for the complexity and cost of closed-loop control. The transmit waveform ramping function required for systems such as DCS1800 can be implemented with a simple Sallen and Key filter on the MC33169 control loop. The amplifier is then ramped on as the  $V_{RAMP}$  pin is taken from 0 V to 3 V. To implement the different power steps required for DCS1800, the  $V_{RAMP}$  pin is ramped between 0 V and the appropriate voltage between 0 V and 3 V for the desired output power. For closed-loop configurations using the MC33169, MMSF4N01HD N-MOS switch and the MRFIC1817 provide a typical 1 MHz 3 dB loop bandwidth. The STANDBY pin must be enabled (3 V) at least 800  $\mu$ s before the  $V_{RAMP}$  pin goes high and disabled (0 V) at least 20 ms before the  $V_{RAMP}$  pin goes low. This STANDBY function allows for the enabling of the MC33169 one burst before the active burst thus reducing power consumption.

### Conclusion

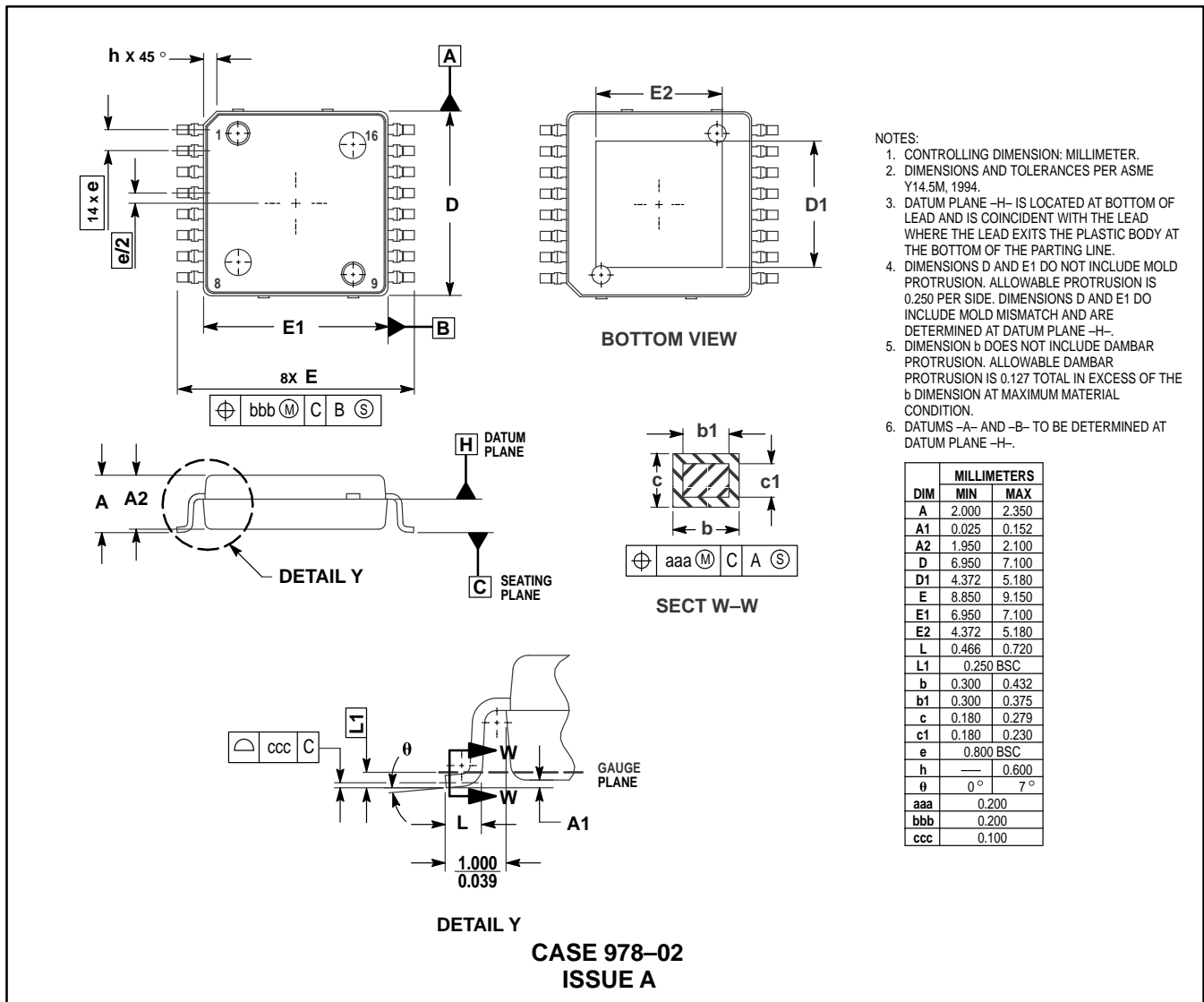
The MRFIC1817 offers the flexibility in matching circuitry and gate biasing required for portable cellular applications. Together with the MC33169 support IC, the device offers an efficient system solution for TDMA applications such as DCS1800 where saturated amplifier operation is used.

For more information about the power control using the MC33169, refer to application note AN1599, "Power Control with the MRFIC0913 GaAs Integrated Power Amplifier and MC33169 Support IC."

### Evaluation Boards

Two versions of the MRFIC1817 evaluation board are available. Order MRFIC1817DCSTF for the 1.8 GHz version and order MRFIC1817PCSTF for the 1.9 GHz version. For a complete list of currently available boards and ones in development for newly introduced product, please contact your local Motorola Distributor or Sales Office.

## PACKAGE DIMENSIONS



Motorola reserves the right to make changes without further notice to any products herein. Motorola makes no warranty, representation or guarantee regarding the suitability of its products for any particular purpose, nor does Motorola assume any liability arising out of the application or use of any product or circuit, and specifically disclaims any and all liability, including without limitation consequential or incidental damages. "Typical" parameters which may be provided in Motorola data sheets and/or specifications can and do vary in different applications and actual performance may vary over time. All operating parameters, including "Typicals" must be validated for each customer application by customer's technical experts. Motorola does not convey any license under its patent rights nor the rights of others. Motorola products are not designed, intended, or authorized for use as components in systems intended for surgical implant into the body, or other applications intended to support or sustain life, or for any other application in which the failure of the Motorola product could create a situation where personal injury or death may occur. Should Buyer purchase or use Motorola products for any such unintended or unauthorized application, Buyer shall indemnify and hold Motorola and its officers, employees, subsidiaries, affiliates, and distributors harmless against all claims, costs, damages, and expenses, and reasonable attorney fees arising out of, directly or indirectly, any claim of personal injury or death associated with such unintended or unauthorized use, even if such claim alleges that Motorola was negligent regarding the design or manufacture of the part. Motorola and are registered trademarks of Motorola, Inc. Motorola, Inc. is an Equal Opportunity/Affirmative Action Employer.

Mfax is a trademark of Motorola, Inc.

**How to reach us:**

**USA/EUROPE/Locations Not Listed:** Motorola Literature Distribution;  
P.O. Box 5405, Denver, Colorado 80217. 1-303-675-2140 or 1-800-441-2447

**JAPAN:** Nippon Motorola Ltd.: SPD, Strategic Planning Office, 4-32-1,  
Nishi-Gotanda, Shinagawa-ku, Tokyo 141, Japan. 81-3-5487-8488

**Customer Focus Center: 1-800-521-6274**

**Mfax™:** RMFAX0@email.sps.mot.com – TOUCHTONE 1-602-244-6609  
Motorola Fax Back System – US & Canada ONLY 1-800-774-1848  
– http://sps.motorola.com/mfax/

**ASIA/PACIFIC:** Motorola Semiconductors H.K. Ltd.; 8B Tai Ping Industrial Park,  
51 Ting Kok Road, Tai Po, N.T., Hong Kong. 852-26629298

**HOME PAGE:** <http://motorola.com/sps/>

