

AD7475/AD7495
FEATURES
Fast Throughput Rate: 1 MSPS
Specified for V_{DD} of 2.7 V to 5.25 V
Low Power:
4.5 mW Max at 1 MSPS with 3 V Supplies
10.5 mW Max at 1 MSPS with 5 V Supplies
Wide Input Bandwidth:
68 dB SNR at 300 kHz Input Frequency
Flexible Power/Serial Clock Speed Management
No Pipeline Delays
High-Speed Serial Interface SPI™/QSPI™ /
MICROWIRE™/DSP-Compatible
On-Board Reference 2.5 V (AD7495 Only)
Standby Mode: 1 μ A Max
8-Lead μ SOIC and SOIC Packages
APPLICATIONS
Battery-Powered Systems
Personal Digital Assistants
Medical Instruments
Mobile Communications
Instrumentation and Control Systems
Data Acquisition Systems
High-Speed Modems
Optical Sensors
GENERAL DESCRIPTION

The AD7475/AD7495 are 12-bit high-speed, low-power, successive-approximation ADCs. The parts operate from a single 2.7 V to 5.25 V power supply and feature throughput rates up to 1 MSPS. The parts contain a low-noise, wide bandwidth track/hold amplifier that can handle input frequencies in excess of 1 MHz.

The conversion process and data acquisition are controlled using \overline{CS} and the serial clock allowing the devices to interface with microprocessors or DSPs. The input signal is sampled on the falling edge of \overline{CS} and conversion is also initiated at this point. There are no pipelined delays associated with the part.

The AD7475/AD7495 use advanced design techniques to achieve very low power dissipation at high throughput rates. With 3 V supplies and 1 MSPS throughput rate, the AD7475 consumes just 1.5 mA, while the AD7495 consumes 2 mA. With 5 V supplies and 1 MSPS, the current consumption is 2.1 mA for the AD7475 and 2.6 mA for the AD7495.

The analog input range for the part is 0 V to REF IN. The 2.5 V reference for the AD7475 is applied externally to the REF IN pin while the AD7495 has an on-board 2.5 V reference. The conversion time is determined by the SCLK frequency.

MICROWIRE is a trademark of National Semiconductor Corporation. SPI and QSPI are trademarks of Motorola, Inc.

REV. A

Information furnished by Analog Devices is believed to be accurate and reliable. However, no responsibility is assumed by Analog Devices for its use, nor for any infringements of patents or other rights of third parties that may result from its use. No license is granted by implication or otherwise under any patent or patent rights of Analog Devices.

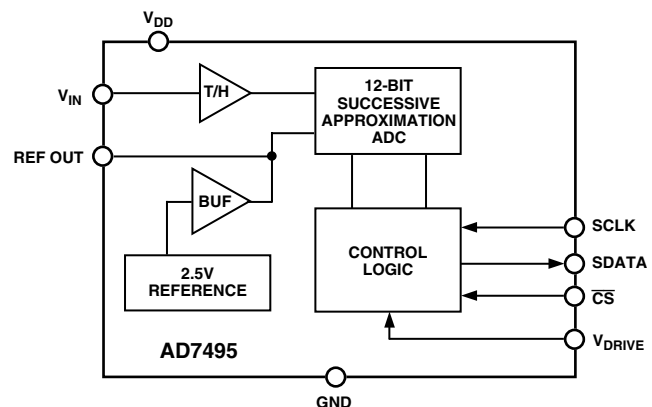
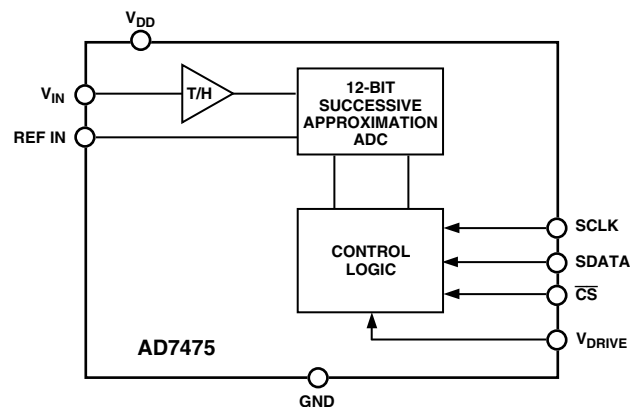
FUNCTIONAL BLOCK DIAGRAMS

PRODUCT HIGHLIGHTS

1. High throughput with low power consumption. The AD7475 offers 1 MSPS throughput rates with 4.5 mW power consumption.
2. Single-supply operation with V_{DRIVE} function. The AD7475/AD7495 operate from a single 2.7 V to 5.25 V supply. The V_{DRIVE} function allows the serial interface to connect directly to either 3 V or 5 V processor systems independent of V_{DD} .
3. Flexible power/serial clock speed management. The conversion rate is determined by the serial clock, allowing the conversion time to be reduced through the serial clock speed increase. The part also features shutdown modes to maximize power efficiency at lower throughput rates. This allows the average power consumption to be reduced while not converting. Power consumption is 1 μ A when in full shutdown.
4. No pipeline delay. The part features a standard successive-approximation ADC with accurate control of the sampling instant via a \overline{CS} input and once off conversion control.

AD7475/AD7495—SPECIFICATIONS¹

AD7475—SPECIFICATIONS¹ ($V_{DD} = 2.7\text{ V to }5.25\text{ V}$, $V_{DRIVE} = 2.7\text{ V to }5.25\text{ V}$, $REF\ IN = 2.5\text{ V}$, $f_{SCLK} = 20\text{ MHz}$ unless otherwise noted; $T_A = T_{MIN}$ to T_{MAX} , unless otherwise noted.)

Parameter	A Version ¹	B Version ¹	Unit	Test Conditions/Comments
DYNAMIC PERFORMANCE				
Signal to Noise + Distortion Ratio (SINAD)	68	68	dB min	$f_{IN} = 300\text{ kHz}$ Sine Wave, $f_{SAMPLE} = 1\text{ MSPS}$
Total Harmonic Distortion (THD)	-75	-75	dB max	$f_{IN} = 300\text{ kHz}$ Sine Wave, $f_{SAMPLE} = 1\text{ MSPS}$
Peak Harmonic or Spurious Noise (SFDR)	-76	-76	dB max	$f_{IN} = 300\text{ kHz}$ Sine Wave, $f_{SAMPLE} = 1\text{ MSPS}$
Intermodulation Distortion (IMD)				
Second Order Terms	-78	-78	dB typ	
Third Order Terms	-78	-78	dB typ	
Aperture Delay	10	10	ns typ	
Aperture Jitter	50	50	ps typ	
Full Power Bandwidth	8.3	8.3	MHz typ	@ 3 dB
Full Power Bandwidth	1.3	1.3	MHz typ	@ 0.1 dB
DC ACCURACY				
Resolution	12	12	Bits	
Integral Nonlinearity	± 1.5	± 1	LSB max	@ 5 V (typ @ 3 V)
	± 0.5	± 0.5	LSB typ	@ 25°C
Differential Nonlinearity	$+1.5/-0.9$	$+1.5/-0.9$	LSB max	@ 5 V Guaranteed No Missed Codes to 12 Bits (typ @ 3 V)
	± 0.5	± 0.5	LSB typ	@ 25°C
Offset Error	± 8	± 8	LSB max	Typically ± 2.5 LSB
Gain Error	± 3	± 3	LSB max	
ANALOG INPUT				
Input Voltage Ranges	0 to REF IN		Volts	
DC Leakage Current	± 1	± 1	$\mu\text{A max}$	
Input Capacitance	20	20	pF typ	
REFERENCE INPUT				
REF IN Input Voltage Range	2.5	2.5	Volts	$\pm 1\%$ for Specified Performance
DC Leakage Current	± 1	± 1	$\mu\text{A max}$	
Input Capacitance	20	20	pF typ	
LOGIC INPUTS				
Input High Voltage, V_{INH}	$V_{DRIVE} - 1$	$V_{DRIVE} - 1$	V min	
Input Low Voltage, V_{INL}	0.4	0.4	V max	
Input Current, I_{IN}	± 1	± 1	$\mu\text{A max}$	Typically 10 nA, $V_{IN} = 0\text{ V}$ or V_{DRIVE}
Input Capacitance, C_{IN}^2	10	10	pF max	
LOGIC OUTPUTS				
Output High Voltage, V_{OH}	$V_{DRIVE} - 0.2$		V min	$I_{SOURCE} = 200\ \mu\text{A}$; $V_{DRIVE} = 2.7\text{ V to }5.25\text{ V}$
Output Low Voltage, V_{OL}	0.4	0.4	V max	$I_{SINK} = 200\ \mu\text{A}$
Floating-State Leakage Current	± 10	± 10	$\mu\text{A max}$	
Floating-State Output Capacitance ²	10	10	pF max	
Output Coding	Straight (Natural) Binary			
CONVERSION RATE				
Conversion Time	800	800	ns max	16 SCLK Cycles with SCLK at 20 MHz
Track/Hold Acquisition Time	300	300	ns max	Sine Wave Input
	325	325	ns max	Full-Scale Step Input
Throughput Rate	1	1	MSPS max	See Serial Interface Section
POWER REQUIREMENTS				
V_{DD}	2.7/5.25	2.7/5.25	V min/max	
V_{DRIVE}	2.7/5.25	2.7/5.25	V min/max	
I_{DD}^3				Digital I/Ps = 0 V or V_{DRIVE}
Normal Mode (Static)	750	750	$\mu\text{A typ}$	$V_{DD} = 2.7\text{ V to }5.25\text{ V}$. SCLK On or Off
Normal Mode (Operational)	2.1	2.1	mA max	$V_{DD} = 4.75\text{ V to }5.25\text{ V}$. $f_{SAMPLE} = 1\text{ MSPS}$
	1.5	1.5	mA max	$V_{DD} = 2.7\text{ V to }3.6\text{ V}$. $f_{SAMPLE} = 1\text{ MSPS}$
Partial Power-Down Mode	450	450	$\mu\text{A typ}$	$f_{SAMPLE} = 100\text{ kSPS}$
Partial Power-Down Mode	100	100	$\mu\text{A max}$	(Static)
Full Power-Down Mode	1	1	$\mu\text{A max}$	SCLK On or Off

AD7475—SPECIFICATIONS (continued)

Parameter	A Version ¹	B Version ¹	Unit	Test Conditions/Comments
POWER REQUIREMENTS				
<i>(continued)</i>				
Power Dissipation ³				
Normal Mode (Operational)	10.5	10.5	mW max	V _{DD} = 5 V. f _{SAMPLE} = 1 MSPS
	4.5	4.5	mW max	V _{DD} = 3 V. f _{SAMPLE} = 1 MSPS
Partial Power-Down (Static)	500	500	μW max	V _{DD} = 5 V
	300	300	μW max	V _{DD} = 3 V
Full Power-Down	5	5	μW max	V _{DD} = 5 V
	3	3	μW max	V _{DD} = 3 V

NOTES

¹Temperature ranges as follows: A, B Versions: -40°C to +85°C.²Sample tested @ 25°C to ensure compliance.³See Power Versus Throughput Rate section.

Specifications subject to change without notice.

AD7495—SPECIFICATIONS¹ (V_{DD} = 2.7 V to 5.25 V, V_{DRIVE} = 2.7 V to 5.25 V, f_{SCLK} = 20 MHz unless otherwise noted; T_A = T_{MIN} to T_{MAX}, unless otherwise noted.)

Parameter	A Version ¹	B Version ¹	Unit	Test Conditions/Comments
DYNAMIC PERFORMANCE				
Signal to Noise + Distortion (SINAD)	68	68	dB min	f _{IN} = 300 kHz Sine Wave, f _{SAMPLE} = 1 MSPS
Total Harmonic Distortion (THD)	-75	-75	dB max	f _{IN} = 300 kHz Sine Wave, f _{SAMPLE} = 1 MSPS
Peak Harmonic or Spurious Noise (SFDR)	-76	-76	dB max	f _{IN} = 300 kHz Sine Wave, f _{SAMPLE} = 1 MSPS
Intermodulation Distortion (IMD)				
Second Order Terms	-78	-78	dB typ	
Third Order Terms	-78	-78	dB typ	
Aperture Delay	10	10	ns typ	
Aperture Jitter	50	50	ps typ	
Full Power Bandwidth	8.3	8.3	MHz typ	@ 3 dB
Full Power Bandwidth	1.3	1.3	MHz typ	@ 0.1 dB
DC ACCURACY				
Resolution	12	12	Bits	
Integral Nonlinearity	±1.5	±1	LSB max	@ 5 V (typ @ 3 V)
	±0.5	±0.5	LSB typ	@ 25°C
Differential Nonlinearity	+1.5/-0.9	+1.5/-0.9	LSB max	@ 5 V Guaranteed No Missed Codes to 12 Bits (typ @ 3 V)
	±0.6	±0.6	LSB typ	@ 25°C
Offset Error	±8	±8	LSB max	Typically ±2.5 LSB
Gain Error	±7	±7	LSB max	Typically ±2.5 LSB
ANALOG INPUT				
Input Voltage Ranges	0 to 2.5	0 to 2.5	Volts	
DC Leakage Current	±1	±1	μA max	
Input Capacitance	20	20	pF typ	
REFERENCE OUTPUT				
REF OUT Output Voltage	2.4625/2.5375	2.4625/2.5375	V min/max	
REF OUT Impedance	10	10	Ω typ	
REF OUT Temperature Coefficient	50	50	ppm/°C typ	
LOGIC INPUTS				
Input High Voltage, V _{INH}	V _{DRIVE} - 1	V _{DRIVE} - 1	V min	
Input Low Voltage, V _{INL}	0.4	0.4	V max	
Input Current, I _{IN}	±1	±1	μA max	Typically 10 nA, V _{IN} = 0 V or V _{DRIVE}
Input Capacitance, C _{IN} ²	10	10	pF max	
LOGIC OUTPUTS				
Output High Voltage, V _{OH}	V _{DRIVE} - 0.2		V min	I _{SOURCE} = 200 μA; V _{DD} = 2.7 V to 5.25 V
Output Low Voltage, V _{OL}	0.4	0.4	V max	I _{SINK} = 200 μA
Floating-State Leakage Current	±10	±10	μA max	
Floating-State Output Capacitance ²	10	10	pF max	
Output Coding	Straight (Natural) Binary			

AD7475/AD7495—SPECIFICATIONS¹

AD7495—SPECIFICATIONS (continued)

Parameter	A Version ¹	B Version ¹	Unit	Test Conditions/Comments
CONVERSION RATE				
Conversion Time	800	800	ns max	16 SCLK Cycles with SCLK at 20 MHz
Track/Hold Acquisition Time	300	300	ns max	Sine Wave Input
	325	325	ns max	Full-Scale Step Input
Throughput Rate	1	1	MSPS max	See Serial Interface Section
POWER REQUIREMENTS				
V _{DD}	2.7/5.25	2.7/5.25	V min/max	
V _{DRIVE}	2.7/5.25	2.7/5.25	V min/max	
I _{DD}				Digital I/Ps = 0 V or V _{DRIVE}
Normal Mode (Static)	1	1	mA typ	V _{DD} = 2.7 V to 5.25 V. SCLK On or Off
Normal Mode (Operational)	2.6	2.6	mA max	V _{DD} = 4.75 V to 5.25 V. f _{SAMPLE} = 1 MSPS
	2	2	mA max	V _{DD} = 2.7 V to 3.6 V. f _{SAMPLE} = 1 MSPS
Partial Power-Down Mode	650	650	μA typ	f _{SAMPLE} = 100 kSPS
Partial Power-Down Mode	230	230	μA max	(Static)
Full Power-Down Mode	1	1	μA max	(Static) SCLK On or Off
Power Dissipation³				
Normal Mode (Operational)	13	13	mW max	V _{DD} = 5 V. f _{SAMPLE} = 1 MSPS
	6	6	mW max	V _{DD} = 3 V. f _{SAMPLE} = 1 MSPS
Partial Power-Down (Static)	1.15	1.15	mW max	V _{DD} = 5 V
	690	690	μW max	V _{DD} = 3 V
Full Power-Down	5	5	μW max	V _{DD} = 5 V
	3	3	μW max	V _{DD} = 3 V

NOTES

¹Temperature ranges as follows: A, B Versions: -40°C to +85°C.

²Sample tested @ 25°C to ensure compliance.

³See Power Versus Throughput Rate section.

Specifications subject to change without notice.

TIMING SPECIFICATIONS¹ (V_{DD} = 2.7 V to 5.25 V, V_{DRIVE} = 2.7 V to 5.25 V, REF IN = 2.5 V (AD7475); T_A = T_{MIN} to T_{MAX}, unless otherwise noted.)

Parameter	Limit at T _{MIN} , T _{MAX} AD7475/AD7495	Unit	Description
f _{SCLK} ²	10 20	kHz min MHz max	
t _{CONVERT}	16 × t _{SCLK} 800	ns max	t _{SCLK} = 1/f _{SCLK} f _{SCLK} = 20 MHz
t _{QUIET}	100	ns min	Minimum Quiet Time Required between Conversions
t ₂	10	ns min	CS to SCLK Setup Time
t ₃ ³	22	ns max	Delay from CS Until SDATA 3-State Disabled
t ₄ ³	40	ns max	Data Access Time after SCLK Falling Edge
t ₅	0.4 t _{SCLK}	ns min	SCLK Low Pulsewidth
t ₆	0.4 t _{SCLK}	ns min	SCLK High Pulsewidth
t ₇	10	ns min	SCLK to Data Valid Hold Time
t ₈ ⁴	10	ns min	SCLK Falling Edge to SDATA High Impedance
	45	ns max	SCLK Falling Edge to SDATA High Impedance
t ₉ ⁴	20	ns max	CS Rising Edge to SDATA High Impedance
t _{POWER-UP}	20	μs max	Power-Up Time from Full Power-Down AD7475
	650	μs max	Power-Up Time from Full Power-Down AD7495

NOTES

¹Sample tested at 25°C to ensure compliance. All input signals are specified with tr = tf = 5 ns (10% to 90% of V_{DRIVE}) and timed from a voltage level of 1.6 V.

²Mark/Space ratio for the SCLK input is 40/60 to 60/40.

³Measured with the load circuit of Figure 3 and defined as the time required for the output to cross 0.8 V or 2.0 V.

⁴t₈ and t₉ are derived from the measured time taken by the data outputs to change 0.5 V when loaded with the circuit of Figure 3. The measured number is then extrapolated back to remove the effects of charging or discharging the 50 pF capacitor. This means that the times, t₈ and t₉, quoted in the timing characteristics are the true bus relinquish time of the part and are independent of the bus loading.

Specifications subject to change without notice.

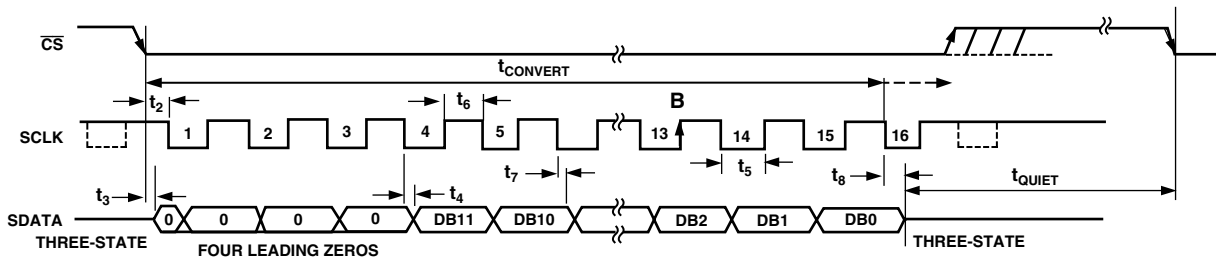

Figure 1. Serial Interface Timing Diagram

Timing Example 1

Having $f_{SCLK} = 20$ MHz and a throughput of 1 MSPS gives a cycle time of $t_2 + 12.5(1/f_{SCLK}) + t_{ACQ} = 1 \mu s$. With $t_2 = 10$ ns min, this leaves t_{ACQ} to be 365 ns. This 365 ns satisfies the requirement of 300 ns for t_{ACQ} . From Figure 2, t_{ACQ} comprises of $2.5(1/f_{SCLK}) + t_8 + t_{QUIET}$, where $t_8 = 45$ ns. This allows a value of 195 ns for t_{QUIET} , satisfying the minimum requirement of 100 ns.

Timing Example 2

Having $f_{SCLK} = 5$ MHz and a throughput of 315 KSPS, gives a cycle time of $t_2 + 12.5(1/f_{SCLK}) + t_{ACQ} = 3.174 \mu s$.

With $t_2 = 10$ ns min, this leaves t_{acq} to be 664 ns. This 664 ns satisfies the requirement of 300 ns for t_{ACQ} . From Figure 2, t_{ACQ} is comprised of $2.5(1/f_{SCLK}) + t_8 + t_{QUIET}$, $t_8 = 45$ ns. This allows a value of 119 ns for t_{QUIET} satisfying the minimum requirement of 100 ns. As in this example and with other slower clock values, the signal may already be acquired before the conversion is complete, but it is still necessary to leave 100 ns minimum t_{QUIET} between conversions. In Example 2 the signal should be fully acquired at approximately Point C in Figure 2.

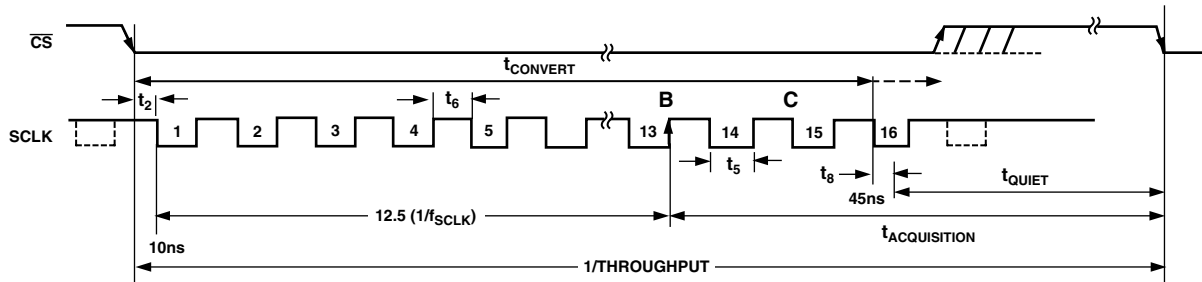

Figure 2. Serial Interface Timing Example

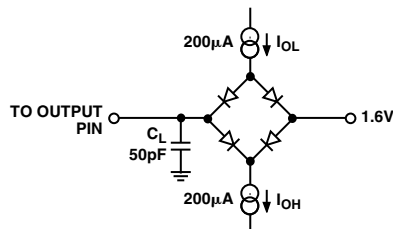

Figure 3. Load Circuit for Digital Output Timing Specifications

AD7475/AD7495

ABSOLUTE MAXIMUM RATINGS¹

(T_A = 25°C unless otherwise noted)

V _{DD} to GND	-0.3 V to +7 V
V _{DRIVE} to GND	-0.3 V to +7 V
Analog Input Voltage to GND	-0.3 V to V _{DD} + 0.3 V
Digital Input Voltage to GND	-0.3 V to +7 V
V _{DRIVE} to DV _{DD}	-0.3 V to DV _{DD} + 0.3 V
Digital Output Voltage to GND	-0.3 V to V _{DD} + 0.3 V
REF IN to GND	-0.3 V to V _{DD} + 0.3 V
Input Current to Any Pin Except Supplies ²	±10 mA
Operating Temperature Range	
Commercial (A, B Version)	-40°C to +85°C
Storage Temperature Range	-65°C to +150°C
Junction Temperature	150°C
SOIC, μSOIC Package, Power Dissipation	450 mW
θ _{JA} Thermal Impedance	157°C/W (SOIC)
	205.9°C/W (μSOIC)
θ _{JC} Thermal Impedance	56°C/W (SOIC)
	43.74°C/W (μSOIC)
Lead Temperature, Soldering	
Vapor Phase (60 secs)	215°C
Infrared (15 secs)	220°C
ESD	4 kV

NOTES

¹Stresses above those listed under Absolute Maximum Ratings may cause permanent damage to the device. This is a stress rating only; functional operation of the device at these or any other conditions above those listed in the operational sections of this specification is not implied. Exposure to absolute maximum rating conditions for extended periods may affect device reliability.

²Transient currents of up to 100 mA will not cause SCR latch-up.

ORDERING GUIDE

Model	Range	Linearity Error (LSB) ¹	Package Option ²	Branding Information
AD7495AR	-40°C to +85°C	±1.5	SO-8	AD7495AR
AD7495BR	-40°C to +85°C	±1	SO-8	AD7495BR
AD7495ARM	-40°C to +85°C	±1.5	RM-8	CCA
AD7495BRM	-40°C to +85°C	±1	RM-8	CCB
AD7475AR	-40°C to +85°C	±1.5	SO-8	AD7475AR
AD7475BR	-40°C to +85°C	±1	SO-8	AD7475BR
AD7475ARM	-40°C to +85°C	±1.5	RM-8	C9A
AD7475BRM	-40°C to +85°C	±1	RM-8	C9B
EVAL-AD7495CB ³	Evaluation Board			
EVAL-AD7475CB ³	Evaluation Board			
EVAL-CONTROL BRD ⁴	Controller Board			

NOTES

¹Linearity Error here refers to Integral Linearity Error.

²SO = SOIC; RM = μSOIC.

³This can be used as a standalone evaluation board or in conjunction with the EVAL-BOARD CONTROLLER for evaluation/demonstration purposes.

⁴This EVALUATION BOARD CONTROLLER is a complete unit allowing a PC to control and communicate with all Analog Devices evaluation boards ending in the CB designators.

CAUTION

ESD (electrostatic discharge) sensitive device. Electrostatic charges as high as 4000 V readily accumulate on the human body and test equipment and can discharge without detection. Although the AD7475/AD7495 features proprietary ESD protection circuitry, permanent damage may occur on devices subjected to high-energy electrostatic discharges. Therefore, proper ESD precautions are recommended to avoid performance degradation or loss of functionality.

PIN CONFIGURATIONS

AD7475 SOIC/μSOIC

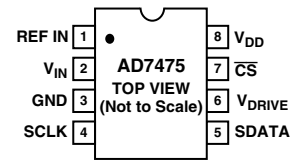

AD7495 SOIC/μSOIC

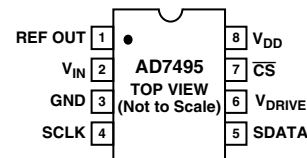

PIN FUNCTION DESCRIPTIONS

Pin No.	Mnemonic	Function
1	REF IN	Reference Input for the AD7475. An external reference must be applied to this input. The voltage range for the external reference is $2.5\text{ V} \pm 1\%$ for specified performance. A cap of a least $0.1\ \mu\text{F}$ should be placed on the REF IN pin.
	REF OUT	Reference Output for the AD7495. A minimum $100\ \text{nF}$ capacitance is required from this pin to GND. The internal reference can be taken from this pin but buffering is required before it is applied elsewhere in a system.
2	V_{IN}	Analog Input. Single-ended analog input channel. The input range is 0 to REF IN.
3	GND	Analog Ground. Ground reference point for all circuitry on the AD7475/AD7495. All analog input signals and any external reference signal should be referred to this GND voltage.
4	SCLK	Serial Clock. Logic input. SCLK provides the serial clock for accessing data from the part. This clock input is also used as the clock source for the AD7475/AD7495's conversion process.
5	SDATA	Data Out. Logic Output. The conversion result from the AD7475/AD7495 is provided on this output as a serial data stream. The bits are clocked out on the falling edge of the SCLK input. The data stream consists of four leading zeros followed by the 12 bits of conversion data which is provided MSB first.
6	V_{DRIVE}	Logic Power Supply Input. The voltage supplied at this pin determines at what voltage the serial interface of the AD7475/AD7495 will operate.
7	$\overline{\text{CS}}$	Chip Select. Active low logic input. This input provides the dual function of initiating conversions on the AD7475/AD7495 and also frames the serial data transfer.
8	V_{DD}	Power Supply Input. The V_{DD} range for the AD7475/AD7495 is from 2.7 V to 5.25 V .

TERMINOLOGY

Integral Nonlinearity

This is the maximum deviation from a straight line passing through the endpoints of the ADC transfer function. The endpoints of the transfer function are zero scale, a point $1/2$ LSB below the first code transition, and full scale, a point $1/2$ LSB above the last code transition.

Differential Nonlinearity

This is the difference between the measured and the ideal 1 LSB change between any two adjacent codes in the ADC.

Offset Error

This is the deviation of the first code transition ($00 \dots 000$) to ($00 \dots 001$) from the ideal, i.e., $\text{AGND} + 0.5$ LSB.

Gain Error

This is the deviation of the last code transition ($111 \dots 110$) to ($111 \dots 111$) from the ideal (i.e., $V_{\text{REF}} - 1.5$ LSB) after the offset error has been adjusted out.

Track/Hold Acquisition Time

The track/hold amplifier returns into track mode on the 13th SCLK rising edge (see Serial Interface section). The Track/Hold Acquisition Time is the minimum time required for the track-and-hold amplifier to remain in track mode for its output to reach and settle to within 0.5 LSB of the applied input signal, given a step change to the input signal.

Signal to (Noise + Distortion) Ratio

This is the measured ratio of signal to (noise + distortion) at the output of the A/D converter. The signal is the rms amplitude of the fundamental. Noise is the sum of all nonfundamental signals up to half the sampling frequency ($f_s/2$), excluding dc. The ratio is dependent on the number of quantization levels in the digitization process; the more levels, the smaller the quantization noise. The theoretical signal to (noise + distortion) ratio for an ideal N -bit converter with a sine wave input is given by:

$$\text{Signal to (Noise + Distortion)} = (6.02N + 1.76)\text{ dB}$$

Thus for a 12-bit converter, this is 74 dB .

Total Harmonic Distortion

Total harmonic distortion (THD) is the ratio of the rms sum of harmonics to the fundamental. For the AD7475/AD7495, it is defined as:

$$\text{THD}(\text{dB}) = 20 \log \frac{\sqrt{V_2^2 + V_3^2 + V_4^2 + V_5^2 + V_6^2}}{V_1}$$

where V_1 is the rms amplitude of the fundamental and V_2, V_3, V_4, V_5 and V_6 are the rms amplitudes of the second through the sixth harmonics.

Peak Harmonic or Spurious Noise

Peak harmonic or spurious noise is defined as the ratio of the rms value of the next largest component in the ADC output spectrum (up to $f_s/2$ and excluding dc) to the rms value of the fundamental. Normally, the value of this specification is determined by the largest harmonic in the spectrum, but for ADCs where the harmonics are buried in the noise floor, it will be a noise peak.

Intermodulation Distortion

With inputs consisting of sine waves at two frequencies, f_a and f_b , any active device with nonlinearities will create distortion products at sum and difference frequencies of $m f_a \pm n f_b$ where $m, n = 0, 1, 2, 3$, etc. Intermodulation distortion terms are those for which neither m nor n is equal to zero. For example, the second order terms include $(f_a + f_b)$ and $(f_a - f_b)$, while the third order terms include $(2f_a + f_b)$, $(2f_a - f_b)$, $(f_a + 2f_b)$ and $(f_a - 2f_b)$.

The AD7475/AD7495 are tested using the CCIF standard where two input frequencies near the top end of the input bandwidth are used. In this case, the second order terms are usually distanced in frequency from the original sine waves while the third order terms are usually at a frequency close to the input frequencies. As a result, the second and third order terms are specified separately. The calculation of the intermodulation distortion is as per the THD specification where it is the ratio of the rms sum of the individual distortion products to the rms amplitude of the sum of the fundamentals expressed in dBs.

AD7475/AD7495

AD7475/AD7495 TYPICAL PERFORMANCE CURVES
 TPC 1 shows a typical FFT plot for the AD7475 at 1 MHz sample rate and 100 kHz input frequency.

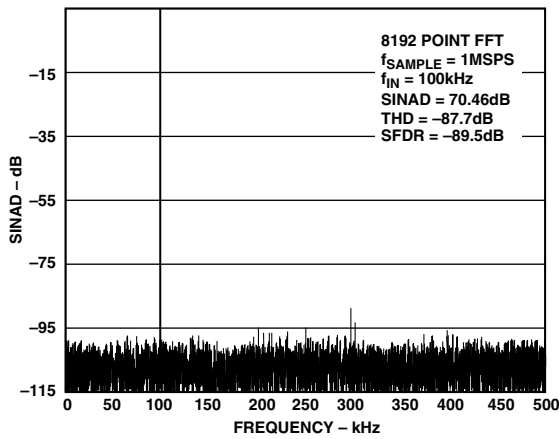

TPC 1. AD7475 Dynamic Performance

TPC 2 shows a typical FFT plot for the AD7495 at 1 MHz sample rate and 100 kHz input frequency.

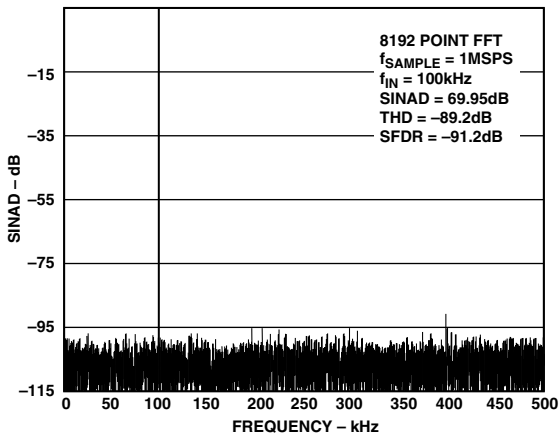

TPC 2. AD7495 Dynamic Performance

TPC 3 shows the signal-to-(noise + distortion) ratio performance versus input frequency for various supply voltages while sampling at 1 MSPS with an SCLK of 20 MHz.

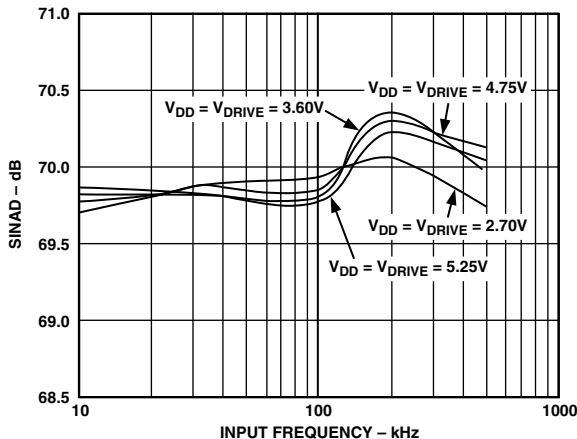

TPC 3. AD7495 SINAD vs. Input Frequency at 1 MSPS

CIRCUIT INFORMATION

The AD7475/AD7495 are fast, micropower, 12-bit, single-supply, A/D converters. The parts can be operated from a 2.7 V to 5.25 V supply. When operated from either a 5 V supply or a 3 V supply, the AD7475/AD7495 are capable of throughput rates of 1 MSPS when provided with a 20 MHz clock.

The AD7475/AD7495 provide the user with an on-chip track/hold, A/D converter, and a serial interface housed in either an 8-lead SOIC or μ SOIC package, which offers the user considerable space-saving advantages over alternative solutions. The AD7495 also has an on-chip 2.5 V reference. The serial clock input accesses data from the part but also provides the clock source for the successive-approximation A/D converter. The analog input range is 0 V to REF IN for the AD7475 and 0 V to REF OUT for the AD7495.

The AD7475/AD7495 also feature power-down options to allow power saving between conversions. The power-down feature is implemented across the standard serial interface as described in the Modes of Operation section.

CONVERTER OPERATION

The AD7475/AD7495 are 12-bit successive approximation analog-to-digital converters based around a capacitive DAC. The AD7475/AD7495 can convert analog input signals in the range 0 V to 2.5 V. Figures 4 and 5 show simplified schematics of the ADC. The ADC comprises of Control Logic, SAR and a Capacitive DAC, which are used to add and subtract fixed amounts of charge from the sampling capacitor to bring the comparator back into a balanced condition. Figure 4 shows the ADC during its acquisition phase. SW2 is closed and SW1 is in Position A. The comparator is held in a balanced condition and the sampling capacitor acquires the signal on V_{IN} .

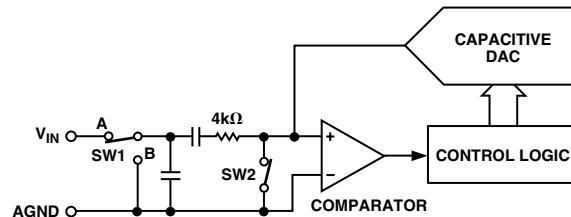

Figure 4. ADC Acquisition Phase

When the ADC starts a conversion (see Figure 5), SW2 will open and SW1 will move to position B causing the comparator to become unbalanced. The Control Logic and the Capacitive DAC are used to add and subtract fixed amounts of charge from the sampling capacitor to bring the comparator back into a balanced condition. When the comparator is rebalanced, the conversion is complete. The Control Logic generates the ADC output code. Figure 6 shows the ADC transfer function.

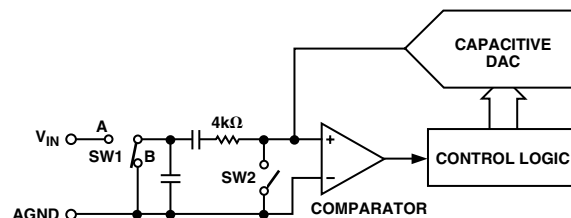

Figure 5. ADC Conversion Phase

ADC TRANSFER FUNCTION

The output coding of the AD7475/AD7495 is straight binary. The designed code transitions occur midway between successive integer LSB values (i.e., 1/2 LSB, 3/2 LSBs, etc.). The LSB size is $= V_{REF}/4096$. The ideal transfer characteristic for the AD7475/AD7495 is shown in Figure 6 below.

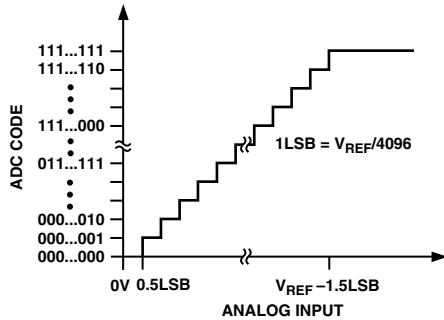

Figure 6. AD7475/AD7495 Transfer Characteristic

TYPICAL CONNECTION DIAGRAM

Figure 7 and Figure 8 show a typical connection diagram for the AD7475 and AD7495 respectively. In both setups the GND pin is connected to the analog ground plane of the system. In Figure 7 REF IN is connected to a decoupled 2.5 V supply from a reference source, the AD780, to provide an analog input range of 0 V to 2.5 V. Although the AD7475 is connected to a V_{DD} of 5 V, the serial interface is connected to a 3 V microprocessor. The V_{DRIVE} pin of the AD7475 is connected to the same 3 V supply of the microprocessor to allow a 3 V logic interface, see Digital Inputs Section. In Figure 8, the REF OUT pin of the AD7495 is connected to a buffer and then applied to a level-shifting circuit used on the analog input to allow a bipolar signal to be applied to the AD7495. A minimum 100 nF capacitance is required on the REF OUT pin to GND. The conversion result from both ADCs is output in a 16-bit word with four leading zeros followed by the MSB of the 12-bit result. For applications where power consumption is of concern, the power-down modes should be used between conversions or bursts of several conversions to improve power performance. See Modes of Operation section of the data sheet.

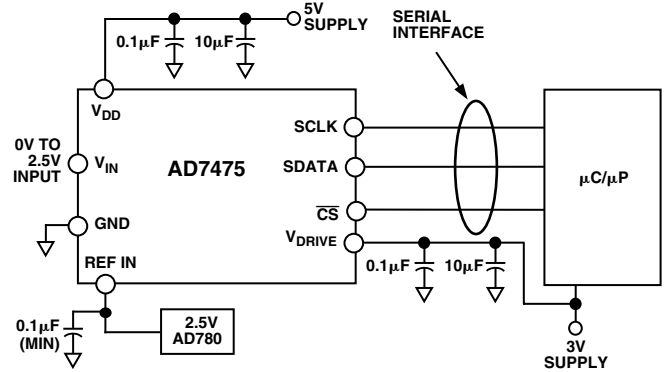

Figure 7. AD7475 Typical Connection Diagram

Analog Input

Figure 9 shows an equivalent circuit of the analog input structure of the AD7475/AD7495. The two diodes D1 and D2 provide ESD protection for the analog inputs. Care must be taken to ensure that the analog input signal never exceeds the supply rails by more than 200 mV. This will cause these diodes to become forward-biased and start conducting current into the substrate. 20 mA is the maximum current these diodes can conduct without causing irreversible damage to the part. The capacitor C1 in Figure 9 is typically about 4 pF and can primarily be attributed to pin capacitance. The resistor R1 is a lumped component made up of the on resistance of a switch. This resistor is typically about 100 Ω . The capacitor C2 is the ADC sampling capacitor and has a capacitance of 16 pF typically. For ac applications, removing high frequency components from the analog input signal is recommended by use of an RC low-pass filter on the relevant analog input pin. In applications where harmonic distortion and signal to noise ratio are critical, the analog input should be driven from a low impedance source. Large source impedances will significantly affect the ac performance of the ADC. This may necessitate the use of an input buffer amplifier. The choice of the op amp will be a function of the particular application.

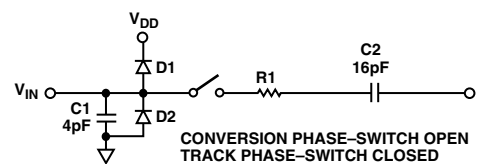

Figure 9. Equivalent Analog Input Circuit

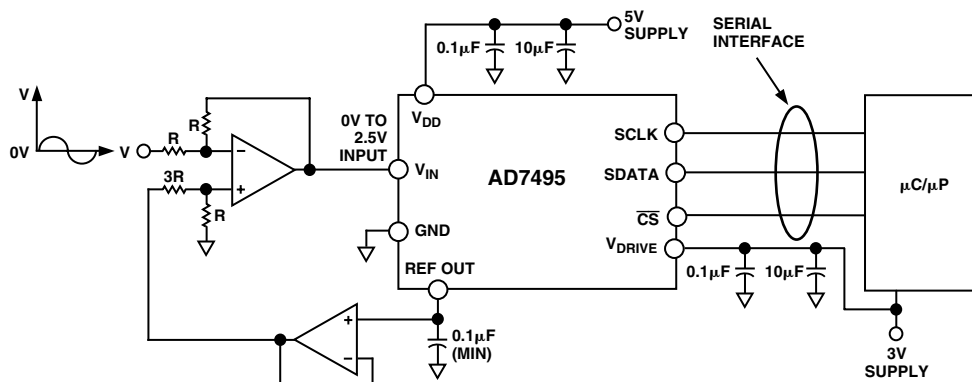

Figure 8. AD7495 Typical Connection Diagram

AD7475/AD7495

When no amplifier is used to drive the analog input, the source impedance should be limited to low values. The maximum source impedance will depend on the amount of total harmonic distortion (THD) that can be tolerated. The THD will increase as the source impedance increases and performance will degrade. Figure 10 shows a graph of the total harmonic distortion versus source impedance for various analog input frequencies.

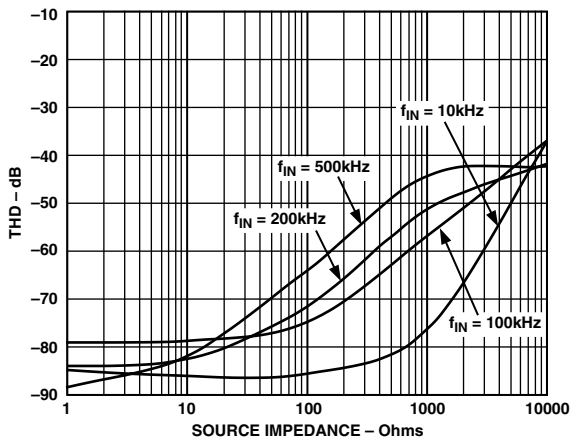

Figure 10. THD vs. Source Impedance for Various Analog Input Frequencies

Figure 11 shows a graph of total harmonic distortion versus analog input frequency for various supply voltages while sampling at 1 MSPS with an SCLK of 20 MHz.

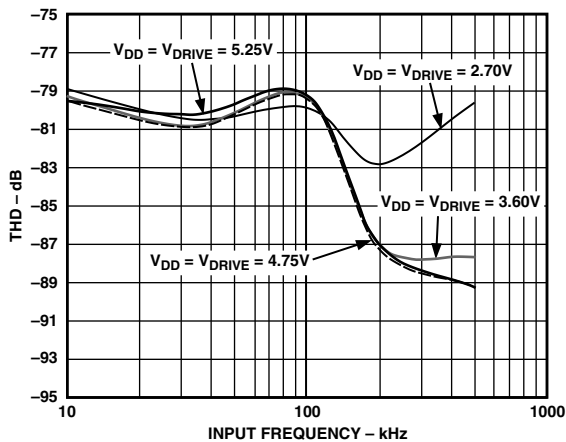

Figure 11. THD vs. Analog Input Frequency for Various Supply Voltages

Digital Inputs

The digital inputs applied to the AD7475/AD7495 are not limited by the maximum ratings which limit the analog inputs. Instead, the digital inputs applied can go to 7 V and are not restricted by the $V_{DD} + 0.3$ V limit as on the analog inputs.

Another advantage of SCLK and \overline{CS} not being restricted by the $V_{DD} + 0.3$ V limit is the fact that power supply sequencing issues are avoided. If \overline{CS} or SCLK are applied before V_{DD} , there is no risk of latch-up as there would be on the analog inputs if a signal greater than 0.3 V were applied prior to V_{DD} .

V_{DRIVE}

The AD7475/AD7495 also has the V_{DRIVE} feature. V_{DRIVE} controls the voltage at which the serial interface operates. V_{DRIVE}

allows the ADC to easily interface to both 3 V and 5 V processors. For example, if the AD7475/AD7495 were operated with a V_{DD} of 5 V, and the V_{DRIVE} pin could be powered from a 3 V supply. The AD7475/AD7495 has better dynamic performance with a V_{DD} of 5 V while still being able to interface to 3 V digital parts.

Care should be taken to ensure V_{DRIVE} does not exceed V_{DD} by more than 0.3 V. (See Absolute Maximum Ratings.)

Reference Section

An external reference source should be used to supply the 2.5 V reference to the AD7475. Errors in the reference source will result in gain errors in the AD7475 transfer function and will add the specified full-scale errors on the part. A capacitor of at least 0.1 μ F should be placed on the REF IN pin. Suitable reference sources for the AD7475 include the AD780, the AD680, and the AD1852.

The AD7495 contains an on-chip 2.5 V reference. As shown in Figure 12, the voltage that appears at the REF OUT pin is internally buffered before being applied to the ADC, the output impedance of this buffer is typically 10 Ω . The reference is capable of sourcing up to 2 mA. The REF OUT pin should be decoupled to AGND using a 100 nF or greater capacitor.

If the 2.5 V internal reference is to be used to drive another device that is capable of glitching the reference at critical times, then the reference will have to be buffered before driving the device. To ensure optimum performance of the AD7495 it is recommended that the Internal Reference not be over driven. If the use of an external reference is required the AD7475 should be used.

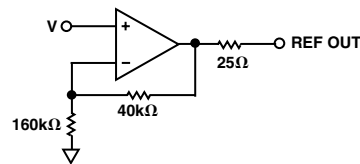

Figure 12. AD7495 Reference Circuit

MODES OF OPERATION

The mode of operation of the AD7475/AD7495 is selected by controlling the (logic) state of the \overline{CS} signal during a conversion. There are three possible modes of operation, Normal Mode, Partial Power-Down Mode, and Full Power-Down Mode. The point at which \overline{CS} is pulled high after the conversion has been initiated will determine which power-down mode, if any, the device will enter. Similarly, if already in a power-down mode, \overline{CS} can control whether the device will return to Normal operation or remain in power-down. These modes of operation are designed to provide flexible power management options. These options can be chosen to optimize the power dissipation/throughput rate ratio for differing application requirements.

Normal Mode

This mode is intended for fastest throughput rate performance as the user does not have to worry about any power-up times with the AD7475/AD7495 remaining fully powered all the time. Figure 13 shows the general diagram of the operation of the AD7475/AD7495 in this mode.

The conversion is initiated on the falling edge of \overline{CS} as described in the Serial Interface section. To ensure the part remains fully powered up at all times, \overline{CS} must remain low until at least 10 SCLK falling edges have elapsed after the falling edge of \overline{CS} . If \overline{CS} is brought high any time after the 10th SCLK falling edge, but

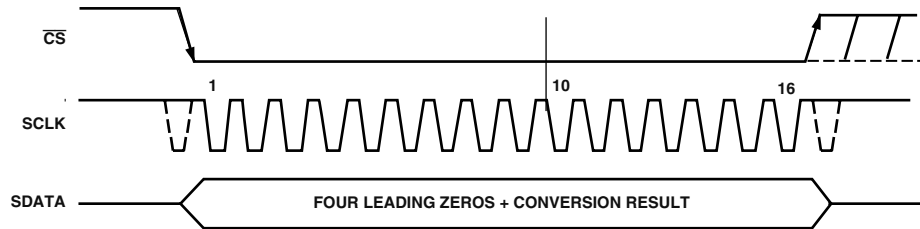

Figure 13. Normal Mode Operation

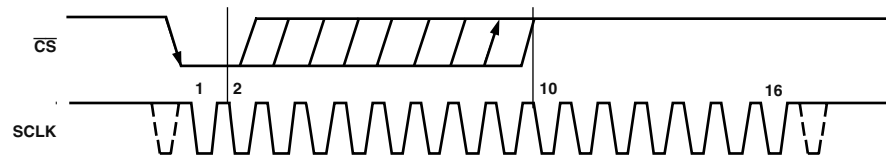

Figure 14. Entering Partial Power-Down Mode

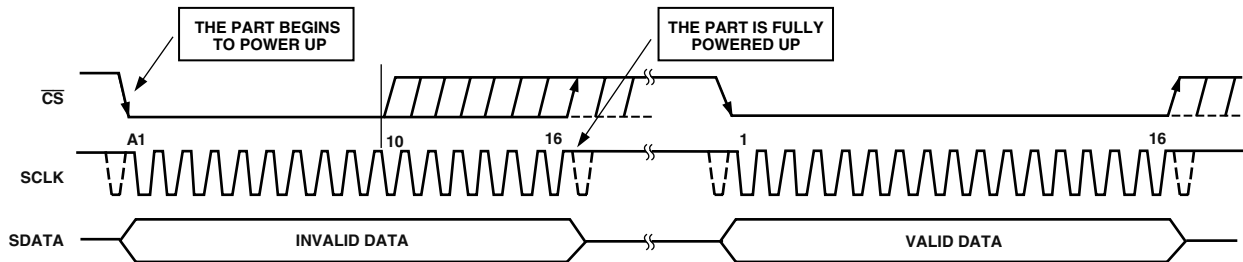

Figure 15. Exiting Partial Power-Down Mode

before the 16th SCLK falling edge, the part will remain powered up but the conversion will be terminated and SDATA will go back into three-state. Sixteen serial clock cycles are required to complete the conversion and access the conversion result. \overline{CS} may idle high until the next conversion or may idle low until sometime prior to the next conversion (effectively idling \overline{CS} low).

Once a data transfer is complete (SDATA has returned to three-state), another conversion can be initiated after the quiet time, t_{QUIET} , has elapsed by bringing \overline{CS} low again.

Partial Power-Down Mode

This mode is intended for use in applications where slower throughput rates are required; either the ADC is powered down between each conversion, or a series of conversions may be performed at a high throughput rate and then the ADC is powered down for a relatively long duration between these bursts of several conversions. When the AD7475 is in partial power-down, all analog circuitry is powered down except for the bias current generator; and, in the case of the AD7495, all analog circuitry is powered down except for the on-chip reference and reference buffer.

To enter partial power-down, the conversion process must be interrupted by bringing \overline{CS} high anywhere after the second falling edge of SCLK and before the tenth falling edge of SCLK as shown in Figure 14. Once \overline{CS} has been brought high in this window of SCLKs, the part will enter partial power-down, and the conversion that was initiated by the falling edge of \overline{CS} will be terminated, and SDATA will go back into three-state. If \overline{CS} is brought high before the second SCLK falling edge, the part will remain in Normal Mode and will not power down. This will avoid accidental power-down due to glitches on the \overline{CS} line.

In order to exit this mode of operation and power the AD7475/AD7495 up again, a dummy conversion is performed. On the

falling edge of \overline{CS} the device will begin to power up, and will continue to power up as long as \overline{CS} is held low until after the falling edge of the tenth SCLK. The device will be fully powered up once 16 SCLKs have elapsed, and valid data will result from the next conversion as shown in Figure 15. If \overline{CS} is brought high before the second falling edge of SCLK, the AD7475/AD7495 will go back into partial power-down again. This avoids accidental power-up due to glitches on the \overline{CS} line; although the device may begin to power up on the falling edge of \overline{CS} , it will power down again on the rising edge of \overline{CS} . If in partial power-down and \overline{CS} is brought high between the second and tenth falling edges of SCLK, the device will enter full power-down mode.

Power-Up Time

The power-up time of the AD7475/AD7495 from partial power-down is typically 1 μs , which means that with any frequency of SCLK up to 20 MHz, one dummy cycle will always be sufficient to allow the device to power up from partial power-down. Once the dummy cycle is complete, the ADC will be fully powered up and the input signal will be acquired properly. The quiet time t_{QUIET} must still be allowed from the point where the bus goes back into three-state after the dummy conversion, to the next falling edge of \overline{CS} . When running at 1 MSPS throughput rate, the AD7475/AD7495 will power up and acquire a signal within ± 0.5 LSB in one dummy cycle, i.e., 1 μs .

When powering up from the power-down mode with a dummy cycle, as in Figure 15, the track-and-hold that was in hold mode while the part was powered down, returns to track mode after the first SCLK edge the part receives after the falling edge of \overline{CS} . This is shown as Point A in Figure 15. Although at any SCLK frequency one dummy cycle is sufficient to power the device up and acquire V_{IN} , it does not necessarily mean that a full dummy

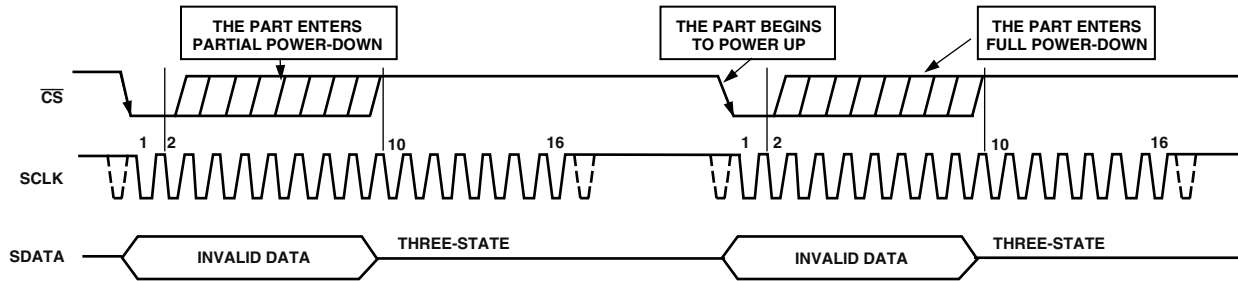

Figure 16. Entering Full Power-Down Mode

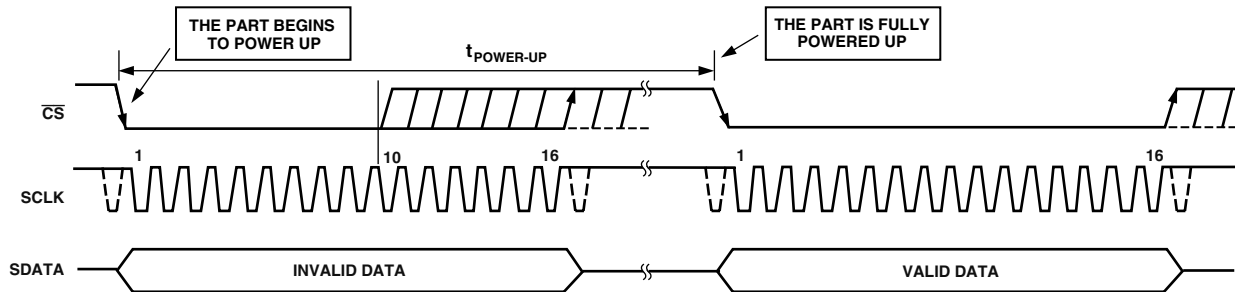

Figure 17. Exiting Full Power-Down Mode

cycle of 16 SCLKs must always elapse to power up the device and fully acquire V_{IN} ; 1 μ s will be sufficient to power the device up and acquire the input signal. If, for example, a 5 MHz SCLK frequency was applied to the ADC, the cycle time would be 3.2 μ s. In one dummy cycle, 3.2 μ s, the part would be powered up and V_{IN} fully acquired. However, after 1 μ s with a 5 MHz SCLK, only 5 SCLK cycles would have elapsed. At this stage, the ADC would be fully powered up and the signal acquired. So, in this case the \overline{CS} can be brought high after the tenth SCLK falling edge and brought low again after a time t_{QUIET} to initiate the conversion.

Full Power-Down Mode

This mode is intended for use in applications where slower throughput rates are required than that in the partial power-down mode, as power up from a full power-down would not be complete in just one dummy conversion. This mode is more suited to applications where a series of conversions performed at a relatively high throughput rate would be followed by a long period of inactivity and hence power-down. When the AD7475/AD7495 is in full power-down, all analog circuitry is powered down.

Full power-down is entered in a way similar to partial power-down, except the timing sequence shown in Figure 14 must be executed twice. The conversion process must be interrupted in a similar fashion by bringing \overline{CS} high anywhere after the second falling edge of SCLK and before the tenth falling edge of SCLK. The device will enter partial power-down at this point. To reach full power-down, the next conversion cycle must be interrupted in the same way as shown in Figure 16. Once \overline{CS} has been brought high in this window of SCLKs, then the part will power down completely.

NOTE: It is not necessary to complete the 16 SCLKs once \overline{CS} has been brought high to enter a power-down mode.

To exit full power-down, and power the AD7475/AD7495 up again, a dummy conversion is performed as when powering up from partial power-down. On the falling edge of \overline{CS} the device will begin to power up, and will continue to power up as

long as \overline{CS} is held low until after the falling edge of the tenth SCLK. The power-up time is longer than one dummy conversion cycle however, and this time, $t_{POWER-UP}$, must elapse before a conversion can be initiated as shown in Figure 17. (See Timing Specifications.)

When power supplies are first applied to the AD7475/AD7495, the ADC may power up in either of the power-down modes or normal mode. Because of this, it is best to allow a dummy cycle to elapse to ensure the part is fully powered up before attempting a valid conversion. Likewise, if it is intended to keep the part in the partial power-down mode immediately after the supplies are applied, then two dummy cycles must be initiated. The first dummy cycle must hold \overline{CS} low until after the tenth SCLK falling edge, Figure 13; in the second cycle \overline{CS} must be brought high before the tenth SCLK edge but after the second SCLK falling edge, Figure 14. Alternatively, if it is intended to place the part in full power-down mode when the supplies have been applied, then three dummy cycles must be initiated. The first dummy cycle must hold \overline{CS} low until after the tenth SCLK edge, Figure 13; the second and third dummy cycle place the part in full power-down, Figure 16. See Modes of Operation section. Once supplies are applied to the AD7475/AD7495, enough time must be allowed, for the AD7475, for the external reference to power up and charge the reference capacitor to its final value. For the AD7495, enough time should be allowed for the internal reference buffer to charge the reference capacitor. Then, to place the AD7475/AD7495 in normal mode, a dummy cycle, 1 μ s, should be initiated. If the first valid conversion is then performed directly after the dummy conversion, care must be taken to ensure that adequate acquisition time has been allowed. As mentioned earlier, when powering up from the power-down mode, the part will return to track upon the first SCLK edge applied after the falling edge of \overline{CS} . However, when the ADC powers up initially after supplies are applied, the track-and-hold will already be in track. This means (assuming one has the facility to monitor the ADC supply current) if the ADC powers up

in the desired mode of operation, and thus a dummy cycle is not required to change mode, then neither is a dummy cycle required to place the track-and-hold into track. If no current monitoring facility is available, the relevant dummy cycle(s) should be performed to ensure the part is in the required mode.

POWER VERSUS THROUGHPUT RATE

By using the partial power-down mode on the AD7475/AD7495 when not converting, the average power consumption of the ADC decreases at lower throughput rates. Figure 18 shows how, as the throughput rate is reduced, the part remains in its partial power-down state longer and the average power consumption over time drops accordingly.

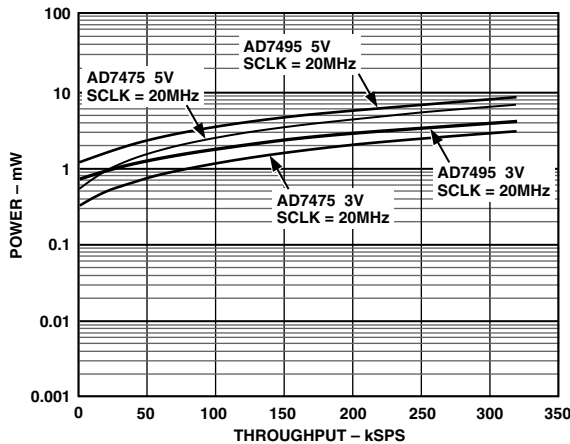

Figure 18. AD7495 Power vs. Throughput for Partial Power-Down

For example if the AD7495 is operated in a continuous sampling mode with a throughput rate of 100 kSPS and an SCLK of 20 MHz ($V_{DD} = 5\text{ V}$), and the device is placed in partial power-down mode between conversions, then the power consumption is calculated as follows. The maximum power dissipation during normal operation is 13 mW ($V_{DD} = 5\text{ V}$). If the power-up time from partial power-down is one dummy cycle, i.e., 1 μs , and the remaining conversion time is another cycle, i.e., 1 μs , then the AD7495 can be said to dissipate 13 mW for 2 μs during each conversion cycle. For the remainder of the conversion cycle, 8 μs , the part remains in partial power-down mode. The AD7495 can be said to dissipate 1.15 mW for the remaining 8 μs of the conversion cycle. If the throughput rate is 100 kSPS, the cycle time is 10 μs and the average power dissipated during each cycle is $(2/10) \times (13\text{ mW}) + (8/10) \times (1.15\text{ mW}) = 3.52\text{ mW}$. If $V_{DD} = 3\text{ V}$, SCLK = 20 MHz and the device is again in partial power-down mode between conversions, the power dissipated during normal operation is 6 mW. The AD7495 can be said to dissipate 6 mW for 2 μs during each conversion cycle and 0.69 mW for the

remaining 8 μs where the part is in partial power-down. With a throughput rate of 100 kSPS, the average power dissipated during each conversion cycle is $(2/10) \times (6\text{ mW}) + (8/10) \times (0.69\text{ mW}) = 1.752\text{ mW}$. Figure 18 shows the power versus throughput rate when using the partial power-down mode between conversions with both 5 V and 3 V supplies for both the AD7475 and AD7495. For the AD7475, partial power-down current is lower than that of the AD7495.

Full power-down mode is intended for use in applications with slower throughput rates than required for the partial power-down mode. It is necessary to leave 650 μs for the AD7495 to be fully powered up from full power-down before initiating a conversion. Current consumptions between conversions is typically less than 1 μA .

Figure 19 shows a typical graph of current versus throughput for the AD7495 while operating in different modes. At slower throughput rates, e.g., 10 SPS to 1 kSPS, the AD7495 was operated in Full Power-Down mode. As the throughput rate increased, up to 100 kSPS, the AD7495 was operated in Partial Power-Down mode, with the part being powered down between conversions. With throughput rates from 100 kSPS to 1 MSPS, the part operated in Normal mode, remaining fully powered up at all times.

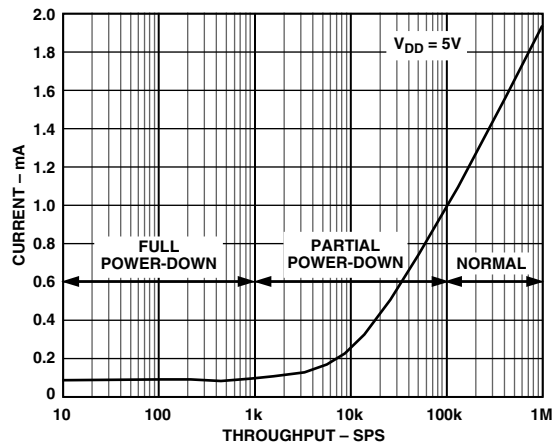

Figure 19. Typical AD7495 Current vs. Throughput

SERIAL INTERFACE

Figure 20 shows the detailed timing diagram for serial interfacing to the AD7475/AD7495. The serial clock provides the conversion clock and also controls the transfer of information from the AD7475/AD7495 during conversion.

$\overline{\text{CS}}$ initiates the data transfer and conversion process. The falling edge of $\overline{\text{CS}}$ puts the track and hold into hold mode, takes the bus out of three-state, and the analog input is sampled at this point.

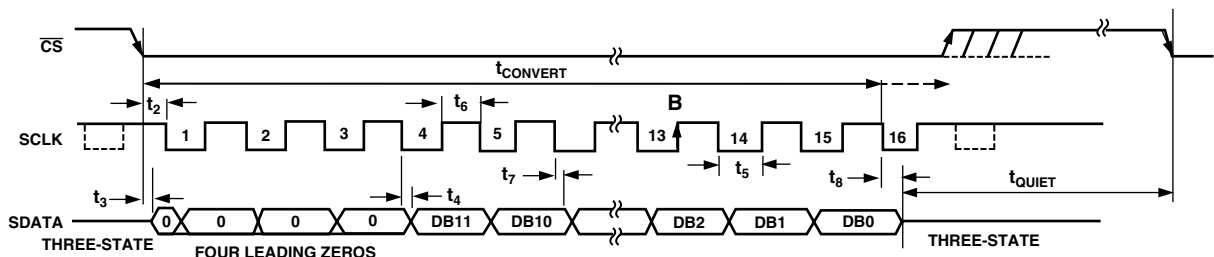

Figure 20. Serial Interface Timing Diagram

AD7475/AD7495

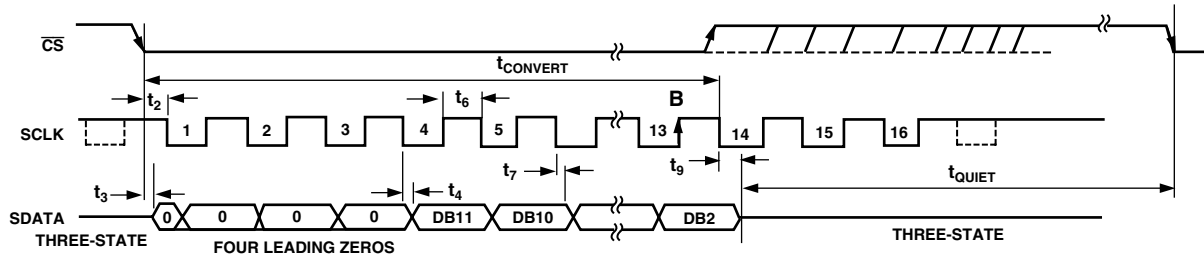

Figure 21. Serial Interface Timing Diagram—Conversion Termination

The conversion is also initiated at this point and will require 16 SCLK cycles to complete. Once 13 SCLK falling edges have elapsed, the track and hold will go back into track on the next SCLK rising edge as shown in Figure 20 at Point B. On the 16th SCLK falling edge the SDATA line will go back into three-state. If the rising edge of CS occurs before 16 SCLKs have elapsed, the conversion will be terminated and the SDATA line will go back into three-state, as shown in Figure 21, otherwise SDATA returns to three-state on the 16th SCLK falling edge as shown in Figure 20.

Sixteen serial clock cycles are required to perform the conversion process and to access data from the AD7475/AD7495. \overline{CS} going low provides the first leading zero to be read in by the microcontroller or DSP. The remaining data is then clocked out by subsequent SCLK falling edges beginning with the 2nd leading zero, thus the first falling clock edge on the serial clock has the second leading zero provided. The final bit in the data transfer is valid on the sixteenth falling edge, having been clocked out on the previous (15th) falling edge.

In applications with a slower SCLK, it may be possible to read in data on each SCLK rising edge, although the first leading zero will still have to be read on the first SCLK falling edge after the \overline{CS} falling edge. Therefore, the first rising edge of SCLK after the \overline{CS} falling edge would provide the second leading zero and the 15th rising SCLK edge would have DB0 provided. This method may not work with most Micros/DSPs, but could possibly be used with FPGAs and ASICs.

MICROPROCESSOR INTERFACING

The serial interface on the AD7475/AD7495 allows the parts to be directly connected to a range of many different microprocessors. This section explains how to interface the AD7475/AD7495 with some of the more common microcontroller and DSP serial interface protocols.

AD7475/AD7495 to TMS320C5x/C54x

The serial interface on the TMS320C5x/C54x uses a continuous serial clock and frame synchronization signals to synchronize the data transfer operations with peripheral devices like the AD7475/AD7495. The \overline{CS} input allows easy interfacing between the TMS320C5x/C54x and the AD7475/AD7495 without any glue logic required. The serial port of the TMS320C5x/C54x is set up to operate in burst mode with internal CLKX (Tx serial clock) and FSX (Tx frame sync). The serial port control register (SPC) must have the following setup: FO = 0, FSM = 1, MCM = 1 and TXM = 1. The format bit, FO, may be set to 1 to set the word length to 8 bits, in order to implement the power-down modes on the AD7475/AD7495.

The connection diagram is shown in Figure 22. It should be noted that for signal processing applications, it is imperative that the frame synchronization signal from the TMS320C5x/C54x provide equidistant sampling. The V_{DRIVE} pin of the AD7475/AD7495 takes the same supply voltage as that of the TMS320C5x/C54x. This allows the ADC to operate at a higher voltage than the serial interface, i.e., TMS320C5x/C54x, if necessary.

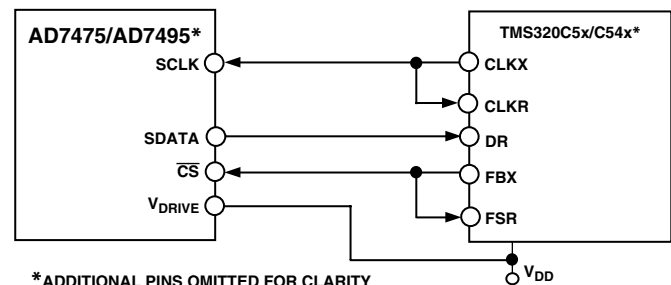

Figure 22. Interfacing to the TMS320C5x/C54x

AD7475/AD7495 to ADSP-21xx

The ADSP-21xx family of DSPs are interfaced directly to the AD7475/AD7495 without any glue logic required. The V_{DRIVE} pin of the AD7475/AD7495 takes the same supply voltage as that of the ADSP-21xx. This allows the ADC to operate at a higher voltage than the serial interface, i.e., ADSP-21xx, if necessary.

The SPORT control register should be set up as follows:

- TFSW = RFSW = 1, Alternate Framing
- INVRFS = INVTFS = 1, Active Low Frame Signal
- DTYPE = 00, Right Justify Data
- SLEN = 1111, 16-Bit Data Words
- ISCLK = 1, Internal Serial Clock
- TFSR = RFSR = 1, Frame Every Word
- IRFS = 0,
- ITFS = 1.

To implement the power-down modes SLEN should be set to 1001 to issue an 8-bit SCLK burst.

The connection diagram is shown in Figure 23. The ADSP-21xx has the TFS and RFS of the SPORT tied together, with TFS set as an output and RFS set as an input. The DSP operates in Alternate Framing Mode and the SPORT control register is set up as described. The Frame synchronizations signal generated on the TFS is tied to \overline{CS} and as with all signal processing applications equidistant sampling is necessary. However, in this example, the timer interrupt is used to control the sampling rate of the ADC and under certain conditions, equidistant sampling may not be achieved.

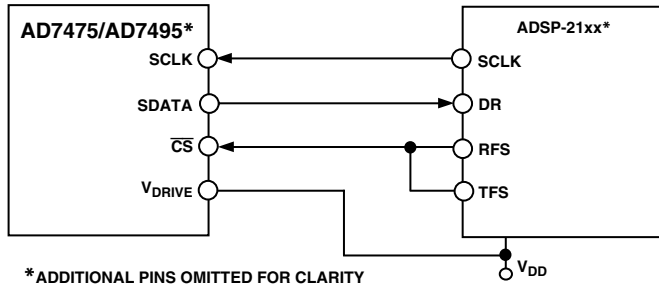

Figure 23. Interfacing to the ADSP-21xx

The Timer registers etc., are loaded with a value that will provide an interrupt at the required sample interval. When an interrupt is received, a value is transmitted with TFS/DT (ADC control word). The TFS is used to control the RFS and hence the reading of data. The frequency of the serial clock is set in the SCLKDIV register. When the instruction to transmit with TFS is given, (i.e., AX0 = TX0), the state of the SCLK is checked. The DSP will wait until the SCLK has gone high, low, and high before transmission will start. If the timer and SCLK values are chosen such that the instruction to transmit occurs on or near the rising edge of SCLK, the data may be transmitted or it may wait until the next clock edge.

For example, the ADSP-2111 has a master clock frequency of 16 MHz. If the SCLKDIV register is loaded with the value 3, an SCLK of 2 MHz is obtained, and eight master clock periods will elapse for every 1 SCLK period. If the timer registers are loaded with the value 803, 100.5 SCLKs will occur between interrupts and subsequently between transmit instructions. This situation will result in nonequidistant sampling as the transmit instruction is occurring on a SCLK edge. If the number of SCLKs between interrupts is a whole integer figure of N, equidistant sampling will be implemented by the DSP.

AD7475/AD7495 to DSP56xxx

The connection diagram in Figure 24 shows how the AD7475/AD7495 can be connected to the SSI (Synchronous Serial Interface) of the DSP56xxx family of DSPs from Motorola. The SSI is operated in Synchronous Mode (SYN bit in CRB = 1) with internally generated 1-bit clock period frame sync for both Tx and Rx (bits FSL1 = 1 and FSL0 = 0 in CRB). Set the word length to 16 by setting bits WL1 = 1 and WL0 = 0 in CRA. To

implement the power-down modes on the AD7475/AD7495 then the word length can be changed to eight bits by setting bits WL1 = 0 and WL0 = 0 in CRA. It should be noted that for signal processing applications, it is imperative that the frame synchronization signal from the DSP56xxx provide equidistant sampling. The V_{DRIVE} pin of the AD7475/AD7495 takes the same supply voltage as that of the DSP56xxx. This allows the ADC to operate at a voltage higher than the serial interface, i.e., DSP56xxx, if necessary.

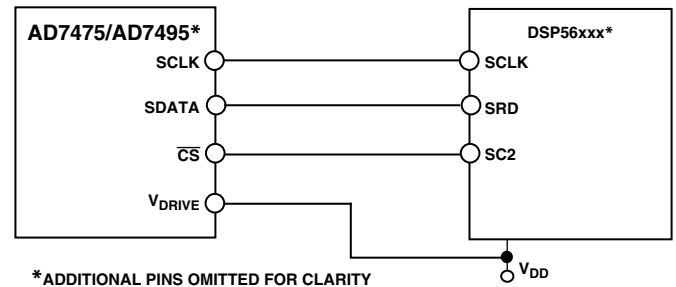

Figure 24. Interfacing to the DSP56xxx

AD7475/AD7495 to MC68HC16

The Serial Peripheral Interface (SPI) on the MC68HC16 is configured for Master Mode (MSTR = 1), Clock Polarity Bit (CPOL) = 1 and the Clock Phase Bit (CPHA) = 0. The SPI is configured by writing to the SPI Control Register (SPCR), see 68HC16 user manual. The serial transfer will take place as a 16-bit operation when the SIZE bit in the SPCR register is set to SIZE = 1. To implement the power-down modes with an 8-bit transfer set SIZE = 0. A connection diagram is shown in Figure 25. The V_{DRIVE} pin of the AD7475/AD7495 takes the same supply voltage as that of the MC68HC16. This allows the ADC to operate at a higher voltage than the serial interface, i.e., MC68HC16, if necessary.

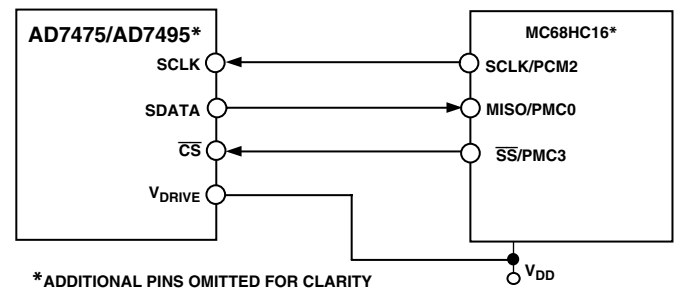
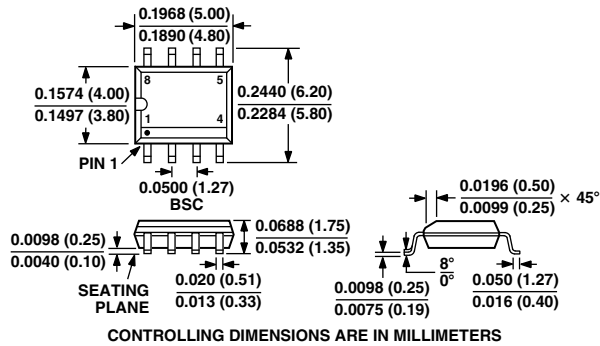

Figure 25. Interfacing to the MC68HC16

OUTLINE DIMENSIONS

Dimensions shown in inches and (mm).

8-Lead SOIC (SO-8)



8-Lead microSOIC (RM-8)

