

Dual Input, High Speed, Dual Channel Power MOSFET Driver



The EL7242/EL7252 dual input, 2-channel drivers achieve the same excellent switching performance of the

EL7212 family while providing added flexibility. The 2-input logic and configuration is applicable to numerous power MOSFET drive circuits. As with other Elantec drivers, the EL7242/EL7252 are excellent for driving large capacitive loads with minimal delay and switching times. "Shoot-thru" protection and latching circuits can be implemented by simply "cross-coupling" the 2-channels.

Pinouts

**EL7242
(8-PIN PDIP, SOIC)
TOP VIEW**

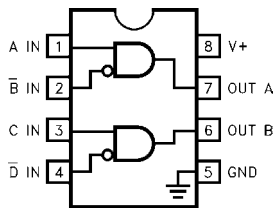

**EL7252
(8-PIN PDIP, SOIC)
TOP VIEW**

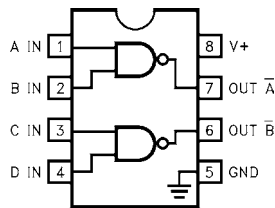

Manufactured under U.S. Patent Nos. 5,334,883, #5,341,047

Features

- Logic AND/NAND input
- 3V and 5V Input compatible
- Clocking speeds up to 10MHz
- 20ns Switching/delay time
- 2A Peak drive
- Isolated drains
- Low output impedance
- Low quiescent current
- Wide operating voltage — 4.5V16V

Applications

- Short circuit protected switching
- Under-voltage shut-down circuits
- Switch-mode power supplies
- Motor controls
- Power MOSFET switching
- Switching capacitive loads
- Shoot-thru protection
- Latching drivers

Ordering Information

PART NUMBER	TEMP. RANGE	PACKAGE	PKG. NO.
EL7242CN	-40°C to +85°C	8-Pin PDIP	MDP0031
EL7242CS	-40°C to +85°C	8-Pin SOIC	MDP0027
EL7252CN	-40°C to +85°C	8-Pin PDIP	MDP0031
EL7252CS	-40°C to +85°C	8-Pin SOIC	MDP0027

EL7242, EL7252

Absolute Maximum Ratings ($T_A = 25^\circ\text{C}$)

Supply (V+ to Gnd) 16.5V
 Input Pins -0.3V to +0.3V above V+
 Combined Peak Output Current4A
 Storage Temperature Range -65°C to +150°C

Ambient Operating Temperature -40°C to +85°C
 Operating Junction Temperature 125°C
 Power Dissipation
 SOIC570mW
 PDIP1050mW

CAUTION: Stresses above those listed in "Absolute Maximum Ratings" may cause permanent damage to the device. This is a stress only rating and operation of the device at these or any other conditions above those indicated in the operational sections of this specification is not implied.

IMPORTANT NOTE: All parameters having Min/Max specifications are guaranteed. Typical values are for information purposes only. Unless otherwise noted, all tests are at the specified temperature and are pulsed tests, therefore: $T_J = T_C = T_A$

DC Electrical Specifications $T_A = 25^\circ\text{C}$, $V = 15\text{V}$ unless otherwise specified

PARAMETER	DESCRIPTION	TEST CONDITIONS	MIN	TYP	MAX	UNITS
INPUT						
V_{IH}	Logic "1" Input Voltage		2.4			V
I_{IH}	Logic "1" Input Current	@V+		0.1	10	μA
V_{IL}	Logic "0" Input Voltage				0.8	V
I_{IL}	Logic "0" Input Current	@0V		0.1	10	μA
V_{HVS}	Input Hysteresis			0.3		V
OUTPUT						
R_{OH}	Pull-Up Resistance	$I_{OUT} = -100\text{mA}$		3	6	Ω
R_{OL}	Pull-Down Resistance	$I_{OUT} = +100\text{mA}$		4	6	Ω
I_{PK}	Peak Output Current	Source Sink		2 2		A
I_{DC}	Continuous Output Current	Source/Sink	100			mA
POWER SUPPLY						
I_S	Power Supply Current	Inputs High		1	2.5	mA
V_S	Operating Voltage		4.5		16	V

AC Electrical Specifications $T_A = 25^\circ\text{C}$, $V = 15\text{V}$ unless otherwise specified

PARAMETER	DESCRIPTION	TEST CONDITIONS	MIN	TYP	MAX	UNITS
SWITCHING CHARACTERISTICS						
t_R	Rise Time	$C_L = 500\text{pF}$ $C_L = 1000\text{pF}$			10 20	ns
t_F	Fall Time	$C_L = 500\text{pF}$ $C_L = 1000\text{pF}$			10 20	ns
t_{D-ON}	Turn-On Delay Time			20	25	ns
t_{D-OFF}	Turn-Off Delay Time			20	25	ns

Timing Table

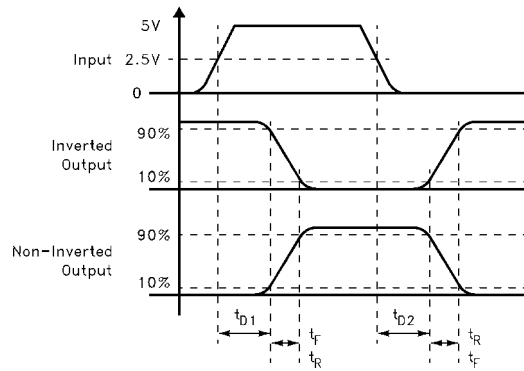

Standard Test Configuration

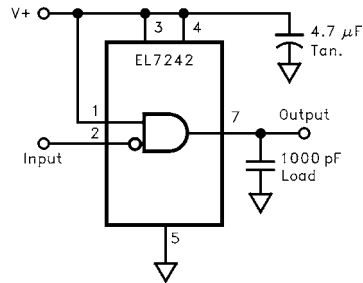

Simplified Schematic

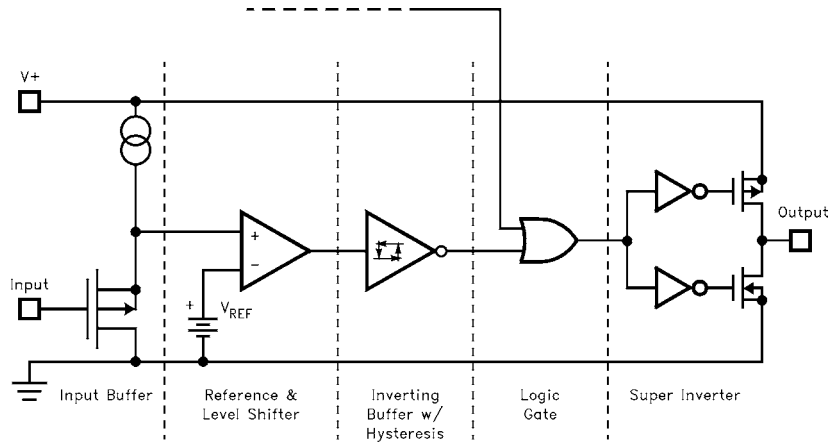

Typical Performance Curves

Max Power/Derating Curves

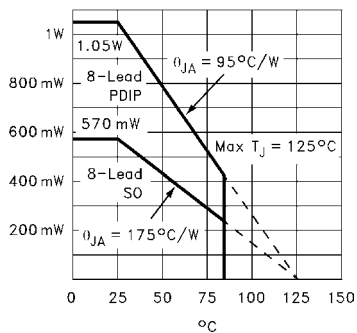

Switch Threshold vs Supply Voltage

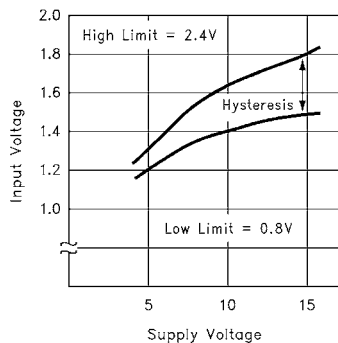

Peak Drive vs Supply Voltage

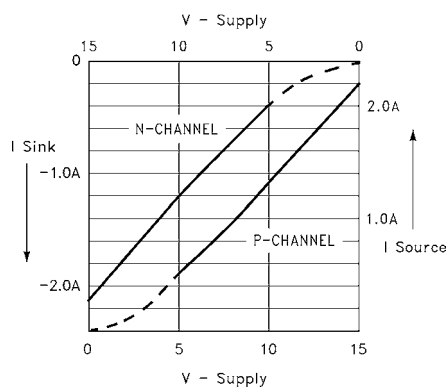

Input Current vs Voltage

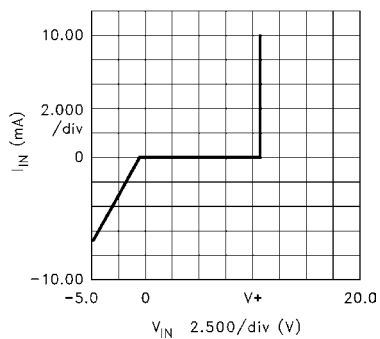

Quiescent Supply Current

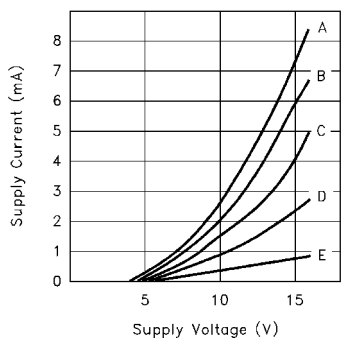

CASE:

A	ALL INPUTS GND
B	3 INPUTS GND
C	2 INPUTS GND
D	1 INPUT GND
E	ALL INPUTS V+

"ON" Resistance vs Supply Voltage

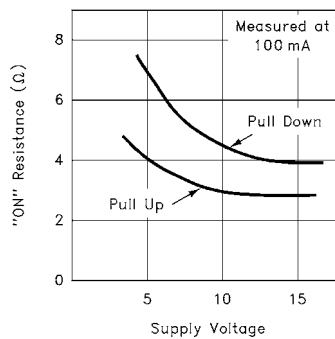

Typical Performance Curves (Continued)

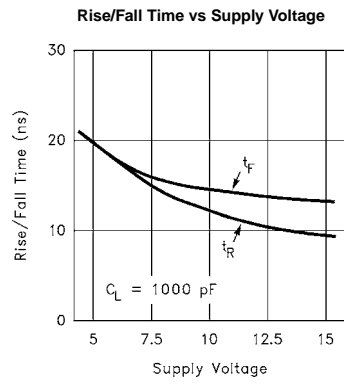
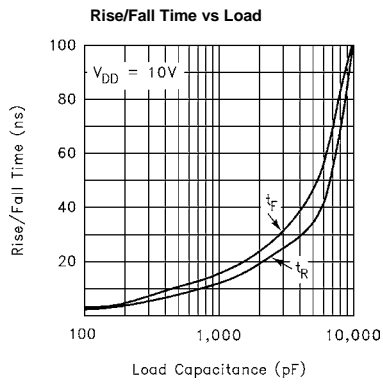
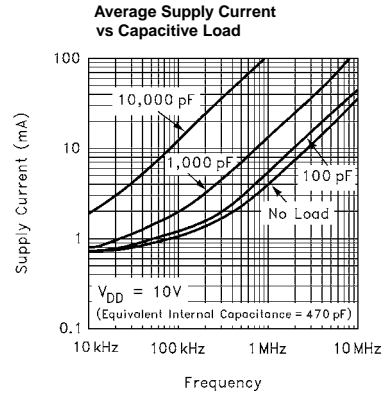
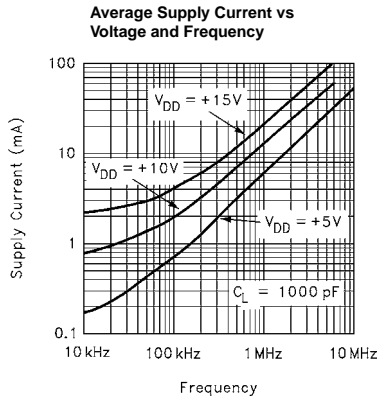

Typical Performance Curves (Continued)

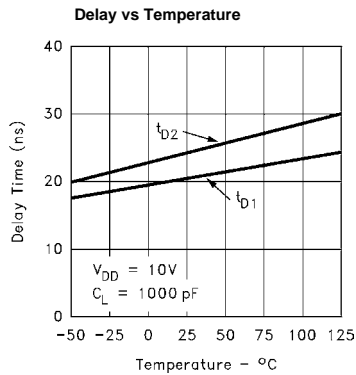
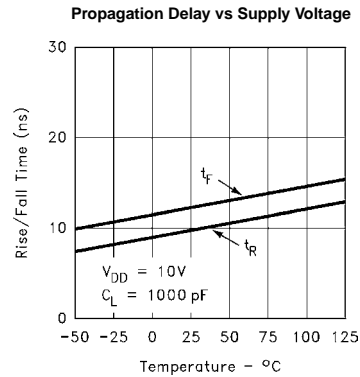
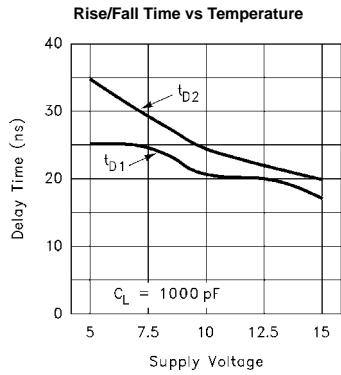

All Intersil U.S. products are manufactured, assembled and tested utilizing ISO9000 quality systems. Intersil Corporation's quality certifications can be viewed at www.intersil.com/design/quality

Intersil products are sold by description only. Intersil Corporation reserves the right to make changes in circuit design, software and/or specifications at any time without notice. Accordingly, the reader is cautioned to verify that data sheets are current before placing orders. Information furnished by Intersil is believed to be accurate and reliable. However, no responsibility is assumed by Intersil or its subsidiaries for its use; nor for any infringements of patents or other rights of third parties which may result from its use. No license is granted by implication or otherwise under any patent or patent rights of Intersil or its subsidiaries.

For information regarding Intersil Corporation and its products, see www.intersil.com