

# PQ3RF23/PQ3RF33

3.3V Output, High Output Current (2A, 3.5A) Type Low Power-loss Voltage Regulators

## ■ Features

- 3.3V output
- High output current  
2A type : PQ3RF23  
3.5A type : PQ3RF33
- Compact resin full-mold package (TO-220 package)
- Low power-loss (Dropout voltage : MAX. 0.5V)
- High-precision output voltage type  
Output voltage precision :  $\pm 2.5\%$
- Built-in ON/OFF control function
- Built-in overcurrent protection, overheat protection function

## ■ Applications

- Power supplies for various electronic equipment such as personal computers

## ■ Outline Dimensions

(Unit : mm)

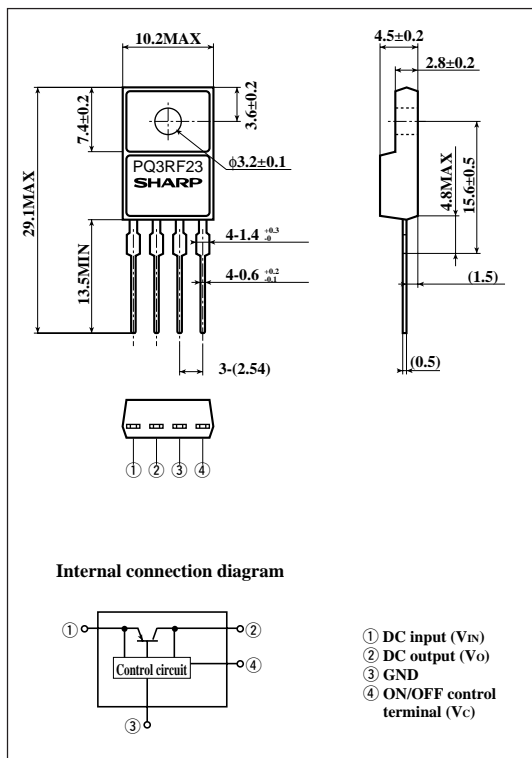

## ■ Absolute Maximum Ratings

( $T_a=25^\circ\text{C}$ )

Parameter	Symbol	Rating	Unit
*1 Input voltage	$V_{IN}$	10	V
*1 ON/OFF control terminal voltage	$V_C$	10	V
Output current	$I_O$	PQ3RF23	2
		PQ3RF33	3.5
Power dissipation (No heat sink)	$P_{D1}$	PQ3RF23	1.5
		PQ3RF33	1.8
Power dissipation (With infinite heat sink)	$P_{D2}$	18	W
*2 Junction temperature	$T_J$	150	$^\circ\text{C}$
Operating temperature	$T_{opr}$	-20 to +80	$^\circ\text{C}$
Storage temperature	$T_{stg}$	-40 to +150	$^\circ\text{C}$
Soldering temperature	$T_{sol}$	260(For 10s.)	$^\circ\text{C}$

\*1 All are open except GND and applicable terminals.

\*2 Overheat protection may operate at  $125 < T_J < 150^\circ\text{C}$ .

· Please refer to the chapter "Handling Precautions".

**SHARP**

" In the absence of confirmation by device specification sheets, SHARP takes no responsibility for any defects that may occur in equipment using any SHARP devices shown in catalogs, data books, etc. Contact SHARP in order to obtain the latest version of the device specification sheets before using any SHARP's device. "

■ Electrical Characteristics

(Unless otherwise specified, conditions shall be  $I_o=1.0A$ [PQ3RF23]/ $I_o=1.5A$ [PQ3RF33],  $V_{IN}=5V$ ,  $T_a=25^{\circ}C$ )

Parameter	Symbol	Conditions	MIN.	TYP.	MAX.	Unit
Output voltage	$V_o$	-	3.218	3.3	3.382	V
Load regulation	$R_{egL}$	$I_o=5mA$ to 2.0A	-	0.2	2	%
		$I_o=5mA$ to 3.5A	-	0.2	2	
Line regulation	$R_{egI}$	$V_{IN}=4$ to 10V	-	0.5	2.5	%
Temperature coefficient of output voltage	$TcV_o$	$T_j=0$ to 125 $^{\circ}C$	-	$\pm 0.02$	-	%/ $^{\circ}C$
Ripple rejection	RR	-	45	55	-	dB
Dropout voltage	$V_{i-o}$	*3, $I_o=2.0A$	-	-	0.5	V
		*3, $I_o=3.0A$	-	-	0.5	
*4 ON-state voltage for control	$V_{C(ON)}$	-	2	-	-	V
ON-state current for control	$I_{C(ON)}$	$V_C=2.7V$	-	-	20	$\mu A$
OFF-state voltage for control	$V_{C(OFF)}$	-	-	-	0.8	V
OFF-state current for control	$I_{C(OFF)}$	$V_C=0.4V$	-	-	-0.4	mA
Quiescent current	$I_q$	$I_o=0A$	-	-	10	mA

\*3 Input voltage shall be the value when output voltage is 95% in comparison with the initial value.

\*4 In case of opening control terminal ④, output voltage turns on.

Fig.1 Test Circuit

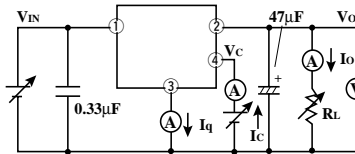

Fig.2 Test Circuit of Ripple Rejection

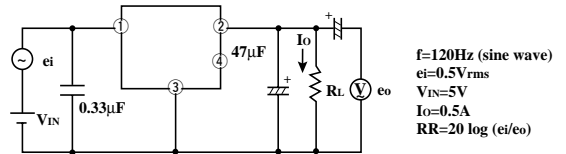
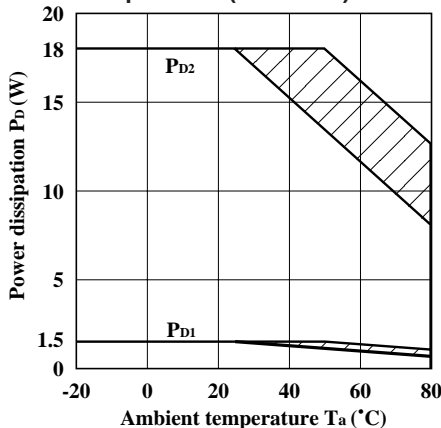
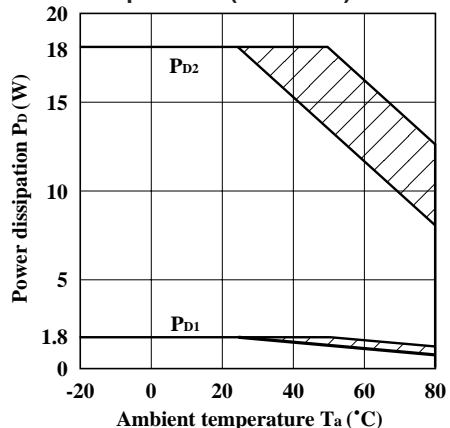

Fig.3 Power Dissipation vs. Ambient Temperature (PQ3RF23)



Note) Oblique line portion: Overheat protection may operate in this area.

Fig.4 Power dissipation vs. Ambient temperature (PQ3RF33)



Note) Oblique line portion: Overheat protection may operate in this area.

Fig.5 Overcurrent Protection Characteristics (PQ3RF23)

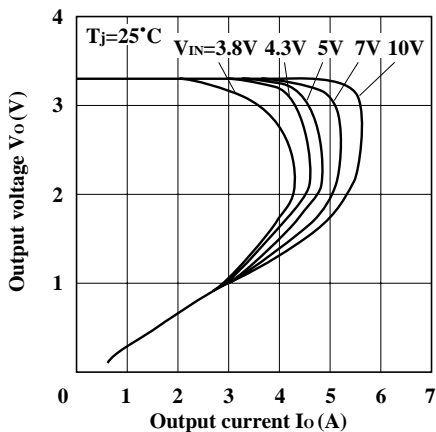

Fig.6 Overcurrent Protection Characteristics (PQ3RF33)

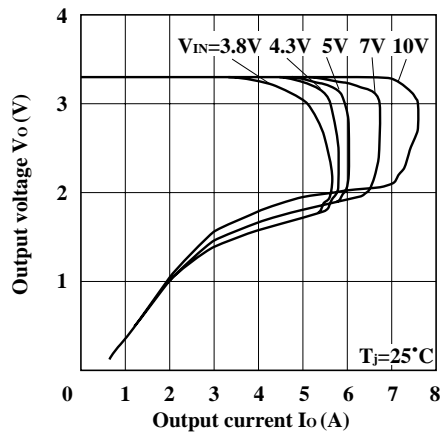

Fig.7 Output Voltage Deviation vs. Junction Temperature (PQ3RF23)

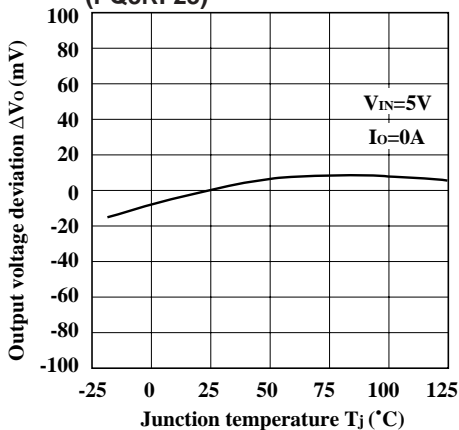

Fig.8 Output Voltage Deviation vs. Junction Temperature (PQ3RF33)

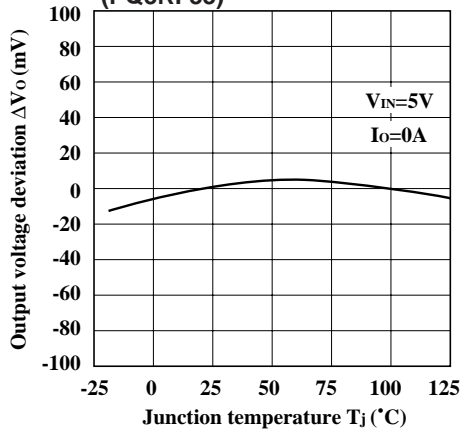

Fig.9 Output Voltage vs. Input Voltage (PQ3RF23)

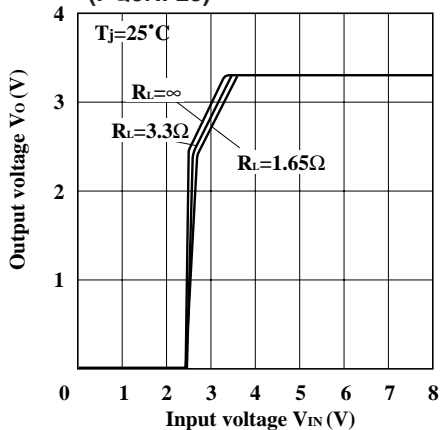

Fig.10 Output Voltage vs. Input Voltage (PQ3RF33)

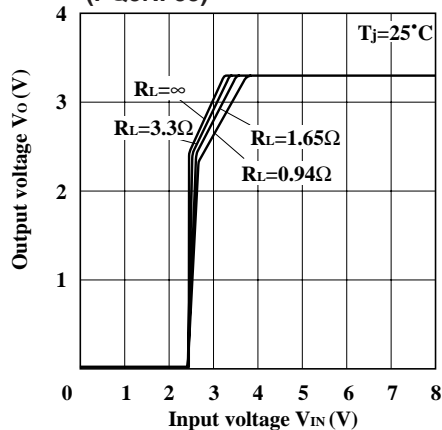

Fig.11 Circuit Operating Current vs. Input Voltage (PQ3RF23)

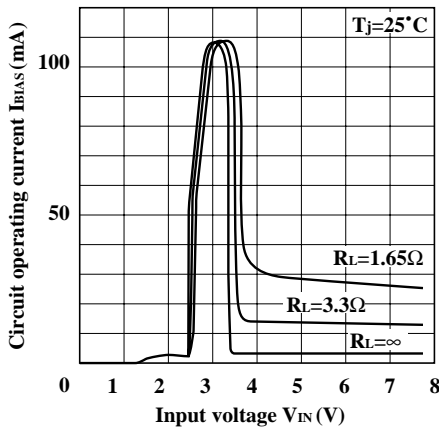

Fig.12 Circuit Operating Current vs. Input Voltage (PQ3RF33)

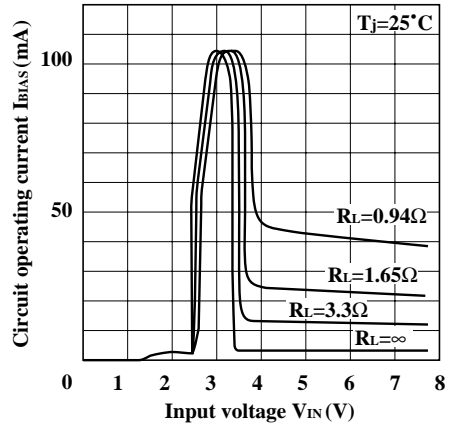

Fig.13 Dropout Voltage vs. Junction Temperature (PQ3RF23)

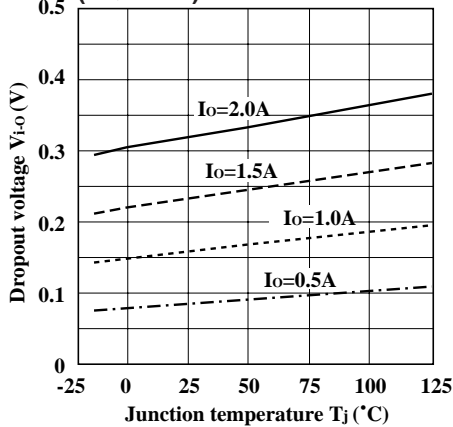

Fig.14 Dropout Voltage vs. Junction Temperature (PQ3RF33)

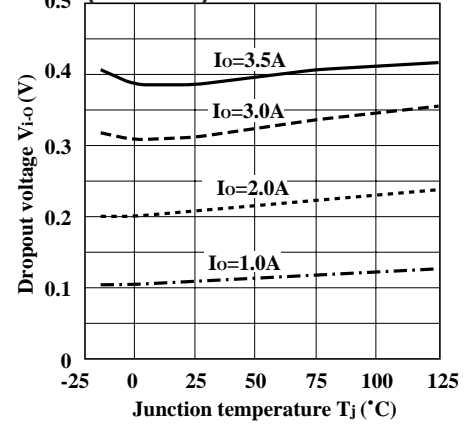

Fig.15 Quiescent Current vs. Junction Temperature (PQ3RF23)

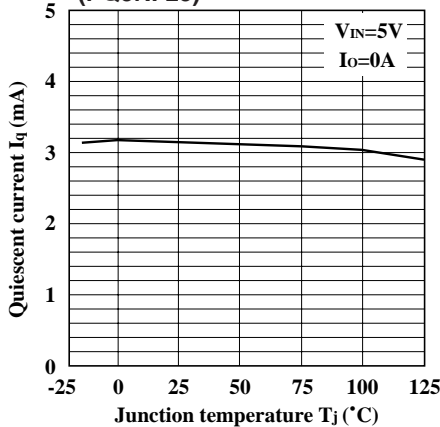

Fig.16 Quiescent Current vs. Junction Temperature (PQ3RF33)

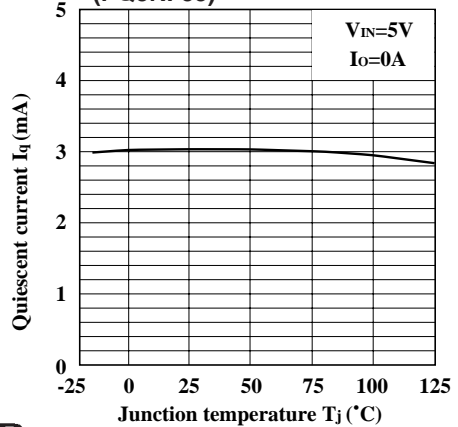

Fig.17 Ripple Rejection vs. Input Ripple Frequency (PQ3RF23)

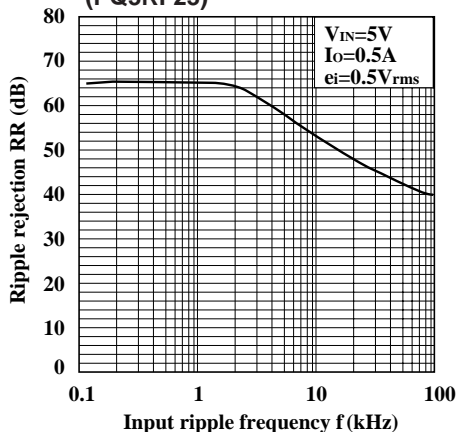

Fig.18 Ripple Rejection vs. Input Ripple Frequency (PQ3RF33)

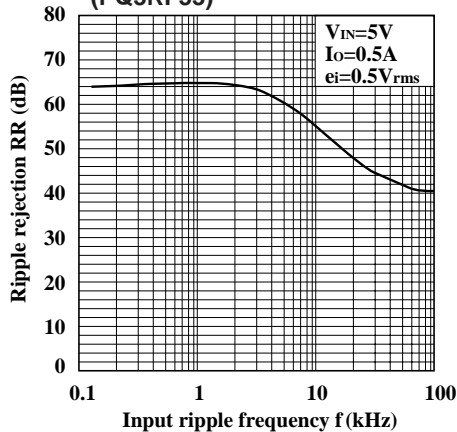

Fig.19 Ripple Rejection vs. Output Current (PQ3RF23)

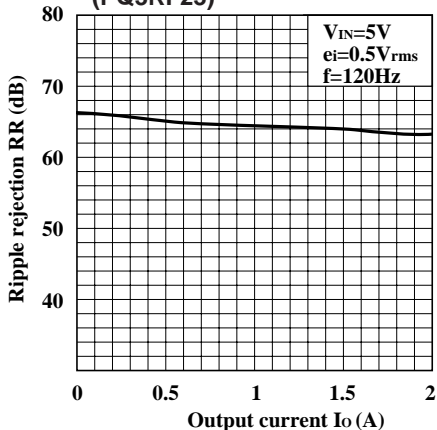

Fig.20 Ripple Rejection vs. Output Current (PQ3RF33)

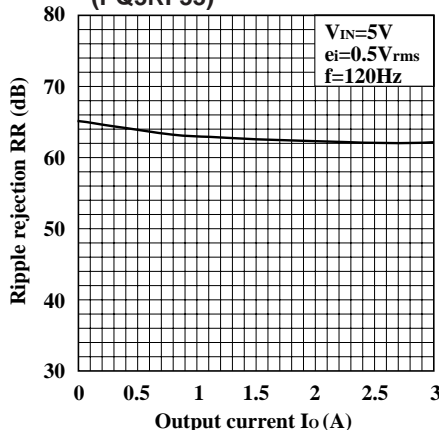

Fig.21 Output Peak Current vs. Junction Temperature (PQ3RF23)

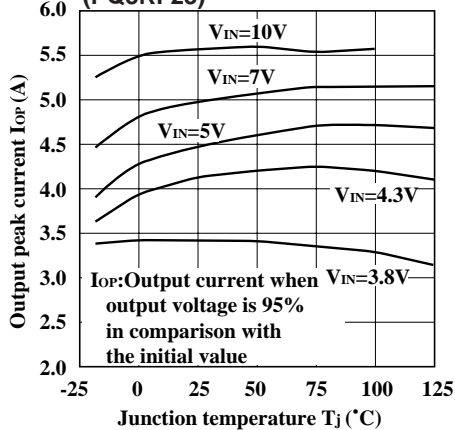
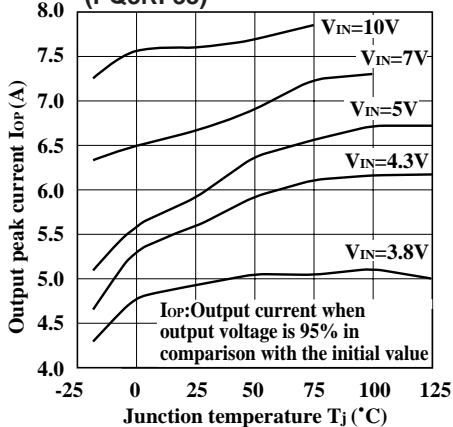

Fig.22 Output Peak Current vs. Junction Temperature (PQ3RF33)



■ Typical Application

