

**Description**

- Capacitor Microphone application

**Features**

- Especially suited for use in audio, telephone capacitor microphones
- Excellent voltage characteristic
- Excellent transient characteristic

**Ordering Information**

Type NO.	Marking	Package Code
STK596K	J□	SOT-623F

□: I<sub>DSS</sub> Rank

**Outline Dimensions**

unit : mm

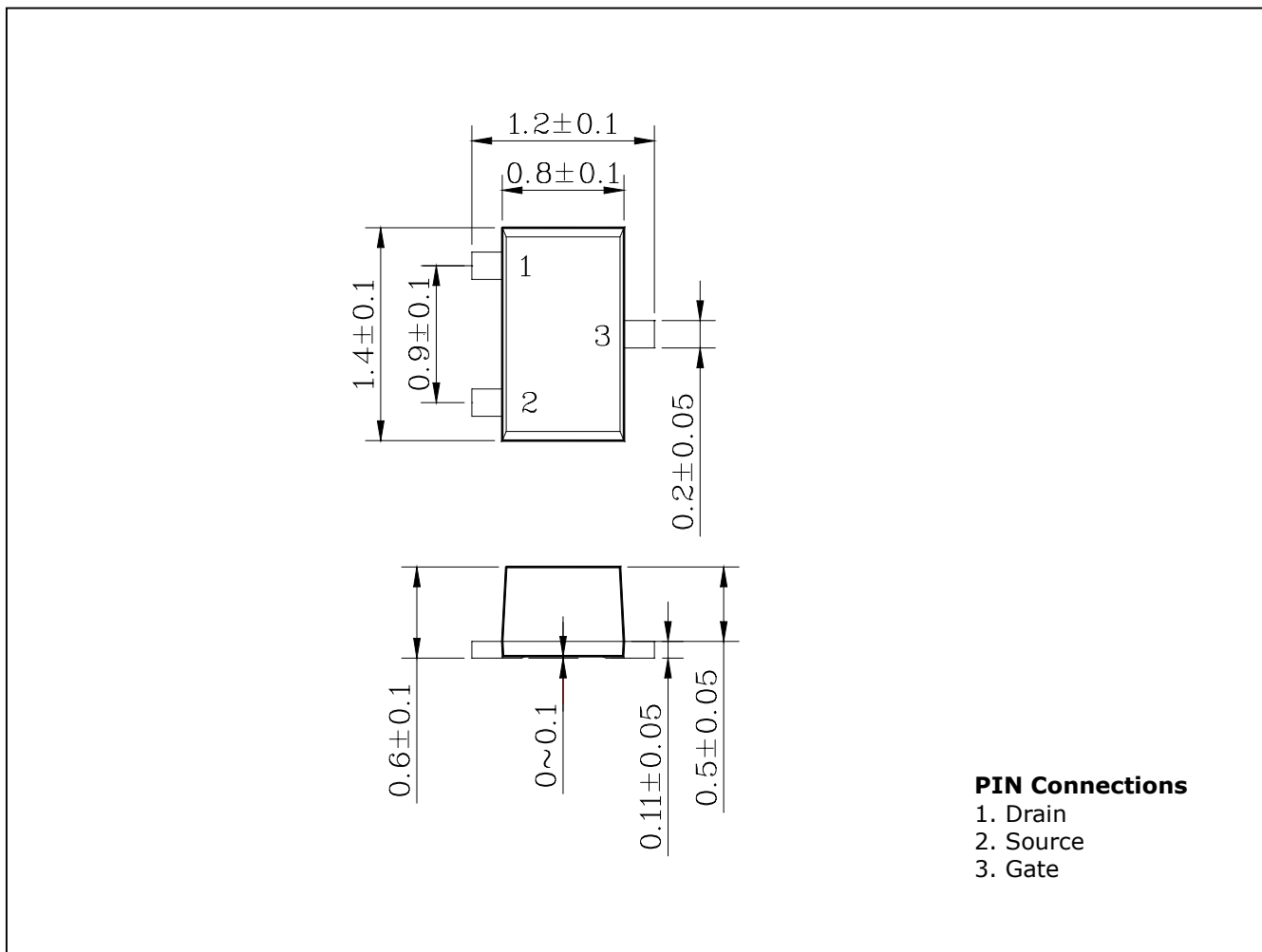

## Absolute maximum ratings

(Ta=25°C)

Characteristic	Symbol	Rating	Unit
Gate-Drain voltage	$V_{GDO}$	-20	V
Gate Current	$I_G$	10	mA
Drain Current	$I_D$	1	mA
Power dissipation	$P_D$	100	mW
Junction Temperature	$T_J$	150	°C
Storage Temperature range	$T_{stg}$	-55~150	°C

## Electrical Characteristics

(Ta=25°C)

Characteristic	Symbol	Test Condition	Min.	Typ.	Max.	Unit
Gate-drain breakdown voltage	$V_{(BR)GDO}$	$I_G = -100\mu A$	-20			V
Cutoff voltage	$V_{GS(off)}$	$V_{DS} = 5V, I_D = 1\mu A$		-0.6	-1.5	V
Zero Voltage Drain current	$I_{DSS}$	$V_{DS} = 5V, V_{GS} = 0$	100		800	$\mu A$
Forward transfer admittance	$ y_{fs} $	$V_{DS} = 5V, V_{GS} = 0, f = 1KHz$	0.4	1.2		mS
Input capacitance	$C_{iss}$	$V_{DS} = 5V, V_{GS} = 0, f = 1MHz$		3.5		pF
Reverse Transfer capacitance	$C_{rss}$	$V_{DS} = 5V, V_{GS} = 0, f = 1MHz$		0.65		pF
Output Noise Voltage	$V_{NO}$	$V_{IN} = 0, A \text{ CURVE}$			-1 1 0	dB

## $I_{DSS}$ Classification

Classification	A	B	C	D	E
$I_{DSS}[\mu A]$	100 ~ 170	150 ~ 240	210 ~ 350	320 ~ 480	440 ~ 800

### Noise Voltage Test Circuit

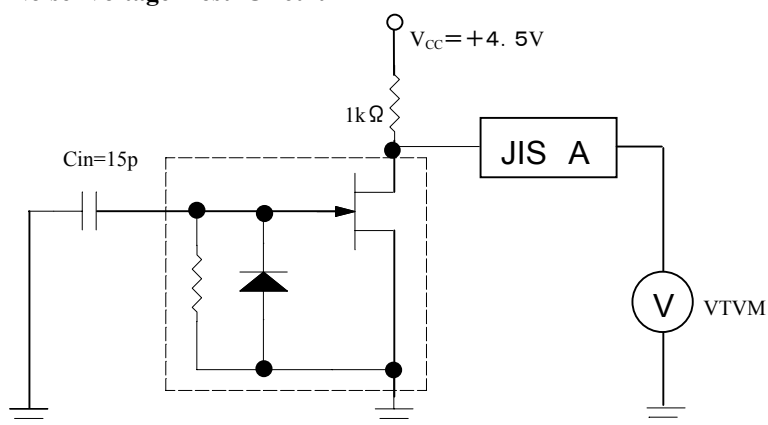

Electrical Characteristic Curves

Fig. 1  $I_D - V_{DS}$

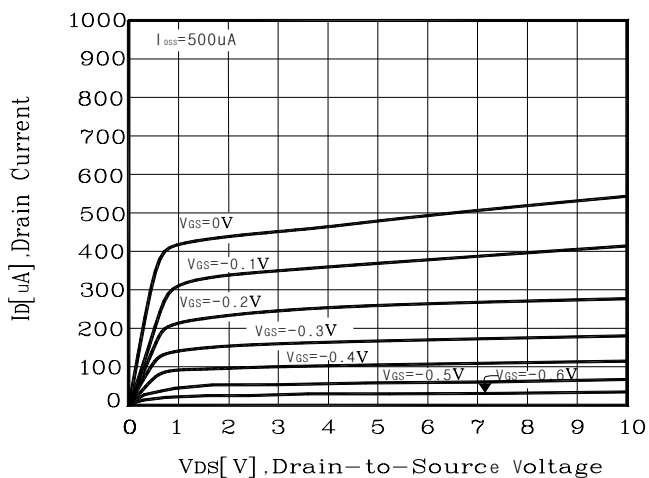

Fig. 2  $I_D - V_{DS}$

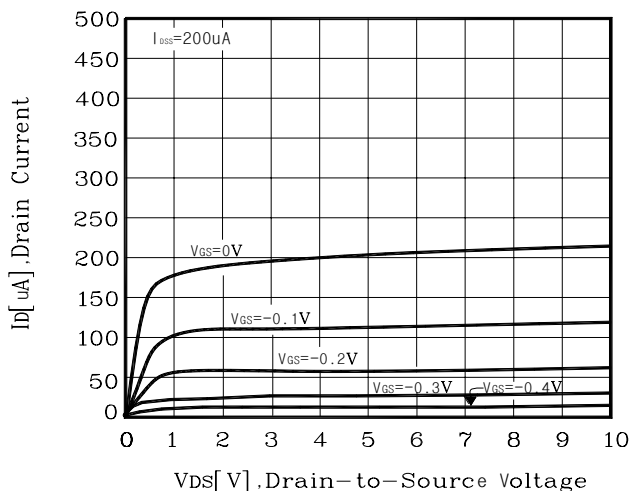

Fig. 3  $I_D - V_{GS}$

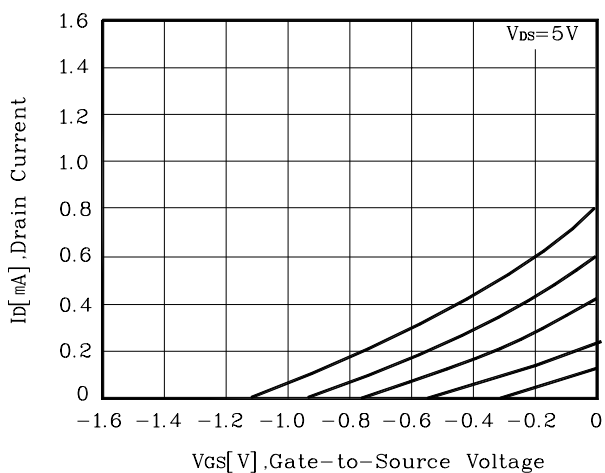

Fig. 4  $|Y_{fs}| - I_{DSS}$

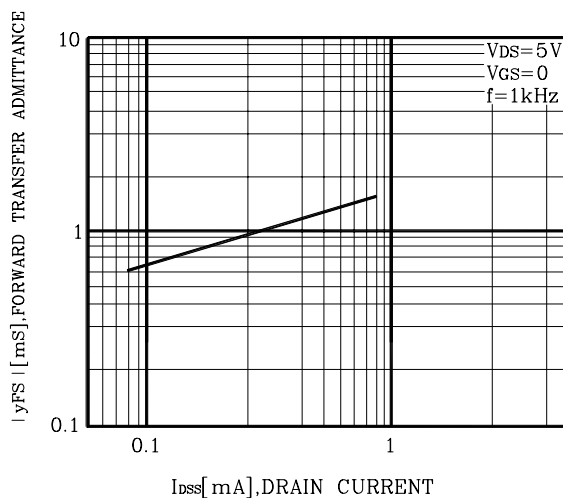

Fig. 5  $V_{GS(Off)} - I_{DSS}$

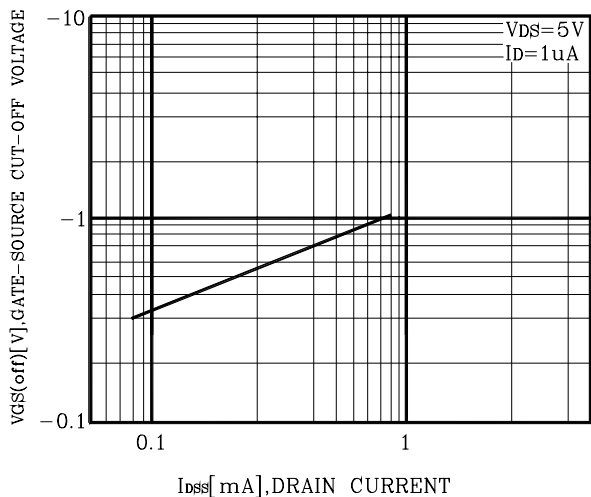
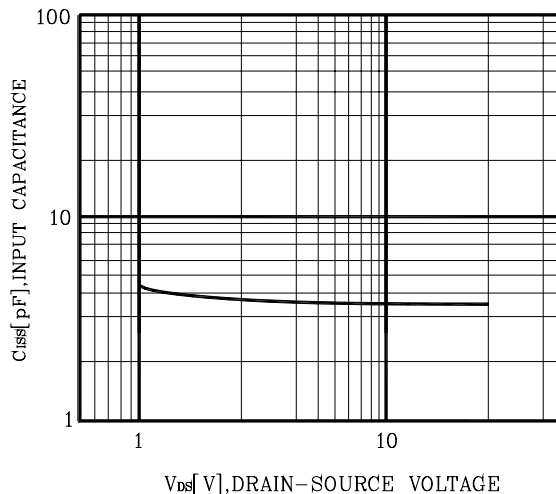

Fig. 6  $C_{iss} - V_{DS}$



Electrical Characteristic Curves

Fig. 7  $C_{rss}$  -  $V_{DS}$

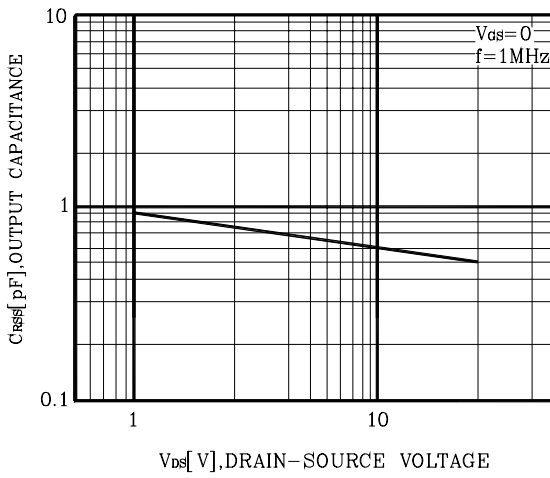

Fig. 8  $P_D$  -  $T_a$

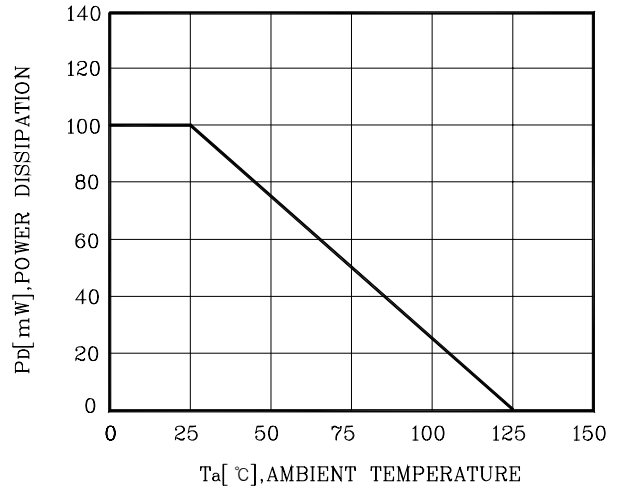
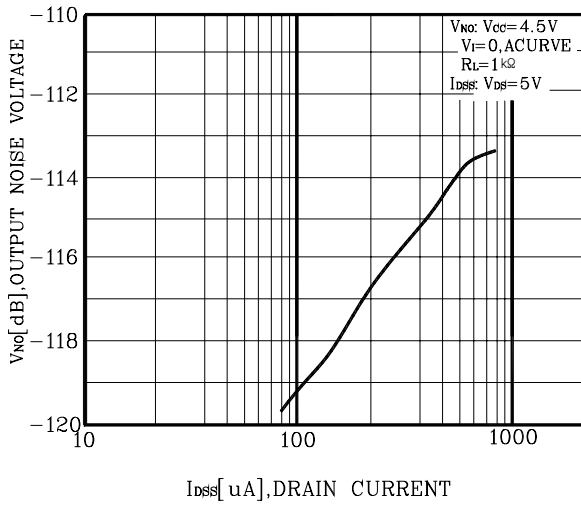

Fig. 9  $V_{NO}$  -  $I_{DSS}$



**These AUK products are intended for usage in general electronic equipments(Office and communication equipment, measuring equipment, domestic electrification, etc.).**

**Please make sure that you consult with us before you use these AUK products in equipments which require high quality and/or reliability, and in equipments which could have major impact to the welfare of human life(atomic energy control, airplane, spaceship, traffic signal, combustion central, all types of safety device, etc.).**

**AUK cannot accept liability to any damage which may occur in case these AUK products were used in the mentioned equipments without prior consultation with AUK.**