

1.5GHz/1.9GHz MIXER GaAs MMIC

■GENERAL DESCRIPTION

NJG1553F is a mixer GaAs MMIC featured low distortion, high conversion gain and low noise figure.

This mixer includes a local amplifier, and ideally suitable for 1.5/1.9GHz band digital mobile phone and PHS handsets.

The very small MTP package is adopted.

■PACKAGE OUTLINE

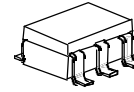

NJG1553F

■FEATURES

- Low voltage operation +2.7V
- High conversion gain 9dB typ. @ $f_{RF}= 1489.0\text{MHz}$, $P_{LO}= -10\text{dBm}$, $P_{RF}= -30\text{dBm}$
7dB typ. @ $f_{RF}= 1900\text{MHz}$, $P_{LO}= -10\text{dBm}$, $P_{RF}= -30\text{dBm}$
- High Input IP3 -1dBm typ. @ $f_{RF1}= 1489.0\text{MHz}$, $f_{RF2}= 1489.1\text{MHz}$
 $P_{LO}= -10\text{dBm}$, $P_{RF}= -30\text{dBm}$
4dBm typ. @ $f_{RF1}= 1900.0\text{MHz}$, $f_{RF2}= 1900.1\text{MHz}$
 $P_{LO}= -10\text{dBm}$, $P_{RF}= -25\text{dBm}$
- Low noise figure 6dB typ. @ $f_{RF}= 1489.0\text{MHz}$, $P_{LO}= -10\text{dBm}$
9dB typ. @ $f_{RF}= 1900\text{MHz}$, $P_{LO}= -10\text{dBm}$
- Package MTP6 (Mount Size: 2.8 x 2.9 x 1.2mm)

■PIN CONFIGURATION

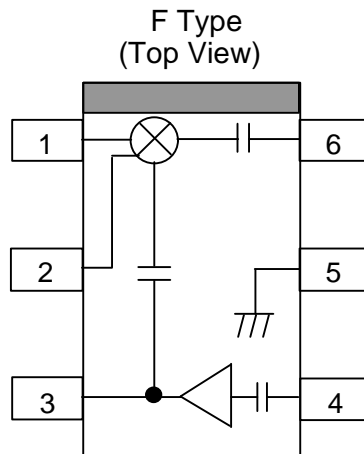

PIN Connection

1. IFOUT
2. BPC
3. VLO
4. LOIN
5. GND
6. RFIN

NOTE :The portion above shows orientation mark printed on the package surface.

NJG1553F

■ABSOLUTE MAXIMUM RATINGS

($T_a=25^{\circ}\text{C}$, $Z_s=Z_l=50\Omega$)

PARAMETERS	SYMBOL	CONDITIONS	RATINGS	UNITS
Mixer Supply Voltage	V_{MIX}		5	V
Local Amplifier Supply Voltage	V_{LO}		5	V
Mixer RF Input Power	P_{RFIN}	$V_{\text{MIX}}=2.7\text{V}$, $V_{\text{LO}}=2.7\text{V}$	10	dBm
Mixer LO Input Power	P_{LOIN}	$V_{\text{MIX}}=2.7\text{V}$, $V_{\text{LO}}=2.7\text{V}$	10	dBm
Power Dissipation	P_{D}		150	mW
Operating Temperature	T_{opr}		-30~+85	$^{\circ}\text{C}$
Storage Temperature	T_{stg}		-40~+150	$^{\circ}\text{C}$

■RECOMMENDED OPERATING RANGE

PARAMETER	SYMBOL	MIN	TYP	MAX	UNITS
Mixer Supply Voltage	V_{MIX}	2.5	2.7	4.5	V
Local Amplifier Supply Voltage	V_{LO}	2.5	2.7	4.5	V

■ELECTRICAL CHARACTERISTICS (DC)

($T_a=25^{\circ}\text{C}$, $V_{\text{MIX}}=2.7\text{V}$, $V_{\text{LO}}=2.7\text{V}$)

PARAMETERS	SYMBOL	CONDITIONS	MIN	TYP	MAX	UNITS
Mixer Current	I_{MIX}	$P_{\text{RF}}=\text{OFF}$, $P_{\text{LO}}=\text{OFF}$	-	5.0	7.0	mA
Local Amplifier Current	I_{LO}	$P_{\text{RF}}=\text{OFF}$, $P_{\text{LO}}=\text{OFF}$	-	2.0	3.2	mA

■ELECTRICAL CHARACTERISTICS (RF 1.5GHz band)

(T_a=25°C, V_{MIX}=2.7V, V_{LO}=2.7V, f_{IF}=130MHz, P_{LO}=-10dBm
Application 1.5GHz, f_{LO}=1619MHz)

PARAMETERS	SYMBOL	CONDITIONS	MIN	TYP	MAX	UNITS
Conversion Gain	G _{C1}	f _{RF} =1489MHz, P _{RF} =-30dBm	6.0	9.0	-	dB
3rd Order Intercept Point	IIP3_1	f _{RF} =1489.0MHz+1489.1MHz	-	-1.0	-	dBm
Noise Figure	NF1	f _{RF} =1489.0MHz	-	6.0	8.0	dB

■ELECTRICAL CHARACTERISTICS (RF 1.9GHz band)

(T_a=25°C, V_{MIX}=2.7V, V_{LO}=2.7V, f_{IF}=240MHz, P_{LO}=-10dBm
Application 1.9GHz, f_{LO}=1660MHz)

PARAMETERS	SYMBOL	CONDITIONS	MIN	TYP	MAX	UNITS
Conversion Gain	G _{C2}	f _{RF} =1900MHz, P _{RF} =-30dBm	4.0	7.0	-	dB
3rd Order Intercept Point	IIP3_2	f _{RF} =1900.0MHz+1900.1MHz	-	4.0	-	dBm
Noise Figure	NF2	f _{RF} =1900.0MHz	-	9.0	11.0	dB

NJG1553F

■ TYPICAL CHARACTERISTICS (Application 1 1.5GHz, $f_{LO}=1619\text{MHz}$)

Conversion Gain , Noise Figure vs. LO Power

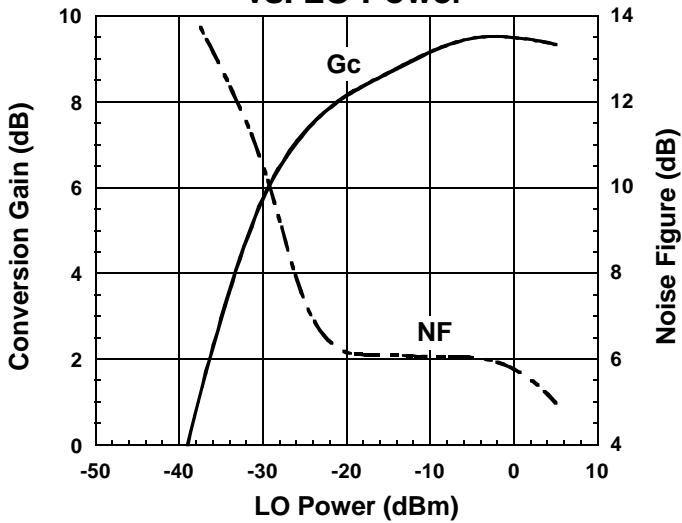

Condition
 $f_{IF}=130\text{MHz}$
 $f_{RF}=1489\text{MHz}, P_{RF}=-30\text{dBm}$
 $f_{LO}=1619\text{MHz}$
 $V_{MIX}=V_{LO}=2.7\text{V}$

IF , IM3 , IM5 vs. RF Power

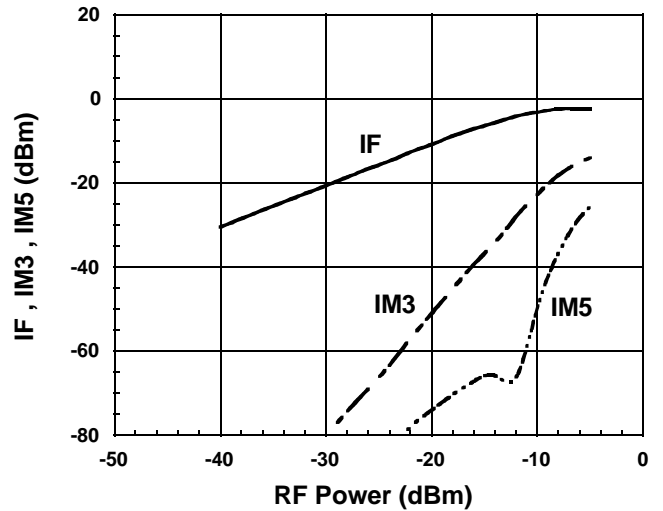

Condition
 $f_{IF}=130\text{MHz}$
 $f_{RF1}=1489.0\text{MHz}$
 $f_{RF2}=1489.1\text{MHz}$
 $f_{LO}=1619\text{MHz}, P_{LO}=-10\text{dBm}$
 $V_{MIX}=V_{LO}=2.7\text{V}$

Conversion Gain , Noise Figure , Input-IP3 vs. V_{MIX} , V_{LO}

Input-IP3 vs. LO Power

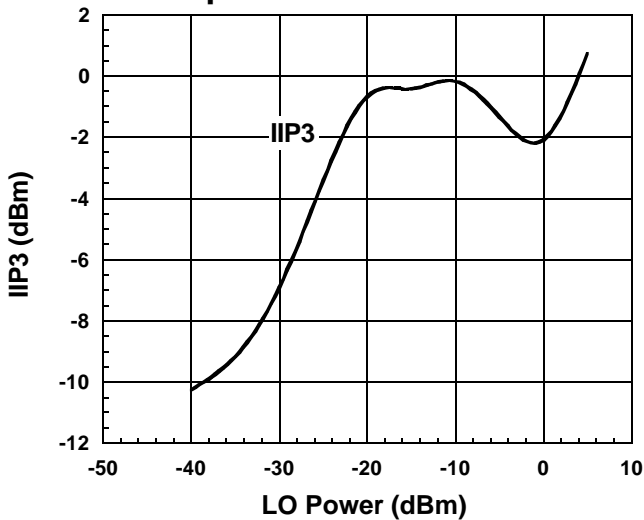

Condition
 $f_{IF}=130\text{MHz}$
 $f_{RF1}=1489.0\text{MHz}, P_{RF}=-30\text{dBm}$
 $f_{RF2}=1489.1\text{MHz}$
 $f_{LO}=1619\text{MHz}$
 $V_{MIX}=V_{LO}=2.7\text{V}$

$$IIP3 = \frac{3IF - IM3}{2} - G_c$$
 @ $P_{RF}=-30\text{dBm}$

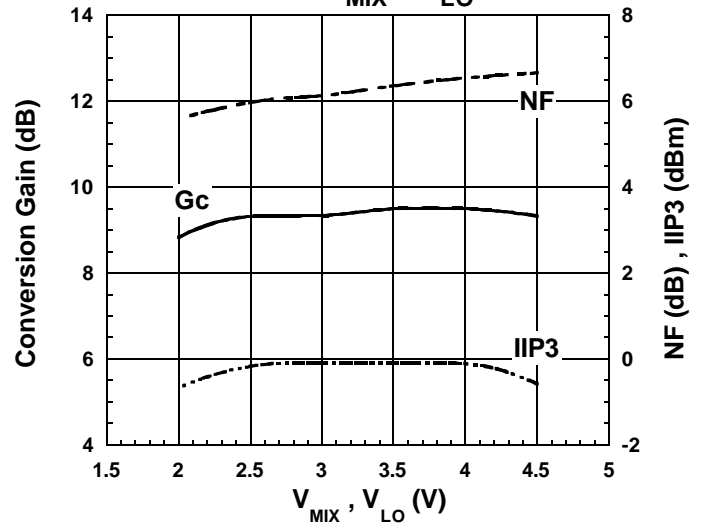

Condition
 $f_{IF}=130\text{MHz}$
 $f_{RF1}=1489.0\text{MHz}, P_{RF}=-30\text{dBm}$
 $f_{RF2}=1489.1\text{MHz}$
 $f_{LO}=1619\text{MHz}, P_{LO}=-10\text{dBm}$

$$IIP3 = \frac{3IF - IM3}{2} - G_c$$
 @ $P_{RF}=-30\text{dBm}$

■ TYPICAL CHARACTERISTICS (Continued)

**Conversion Gain vs. LO Power
Temperature Response**

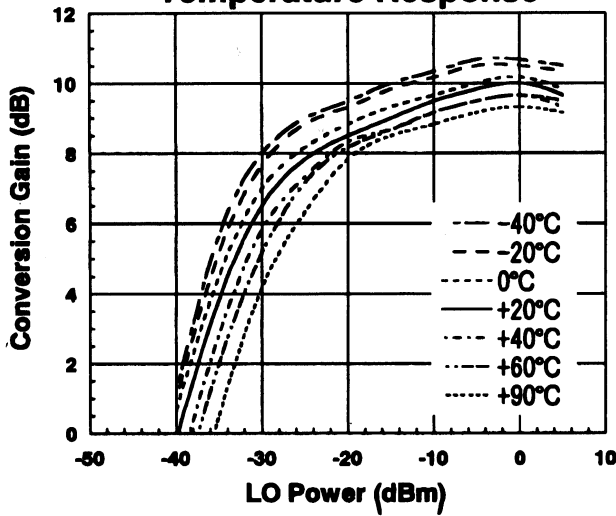

Condition
 $f_{IF}=130\text{MHz}$
 $f_{RF}=1489\text{MHz}, P_{RF}=-30\text{dBm}$
 $f_{LO}=1619\text{MHz}$
 $V_{MIX}=V_{LO}=2.7\text{V}$

**Noise Figure vs. LO Power
Temperature Response**

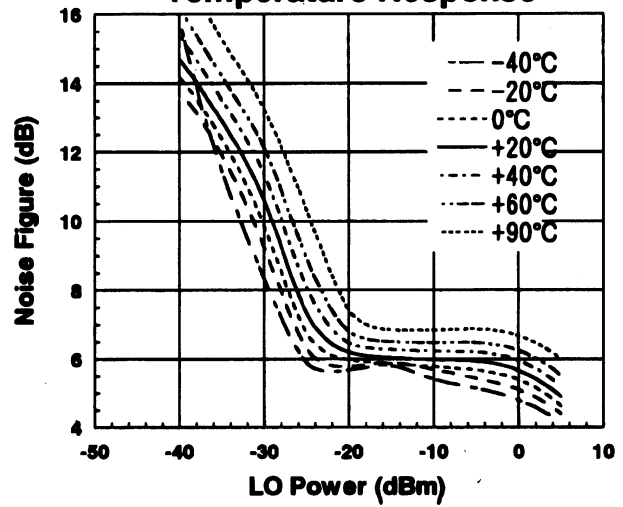

Condition
 $f_{IF}=130\text{MHz}$
 $f_{RF}=1489\text{MHz}$
 $f_{LO}=1619\text{MHz}$
 $V_{MIX}=V_{LO}=2.7\text{V}$

**Input-IP3 vs. LO Power
Temperature Response**

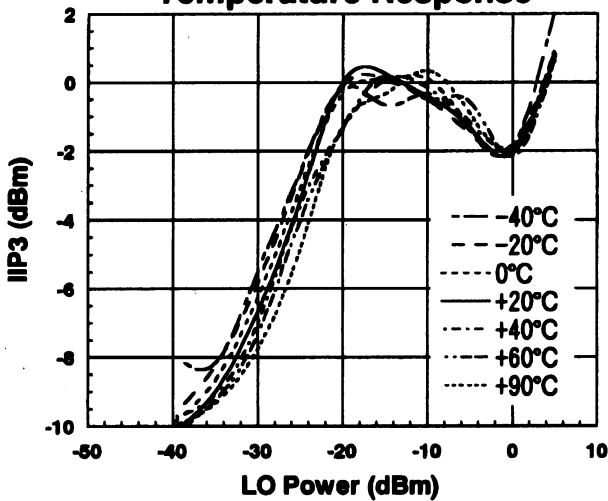

Condition
 $f_{IF}=130\text{MHz}$
 $f_{RF1}=1489.0\text{MHz}, P_{RF}=-30\text{dBm}$
 $f_{RF2}=1489.1\text{MHz}$
 $f_{LO}=1619\text{MHz}$
 $V_{MIX}=V_{LO}=2.7\text{V}$

$$IIP3 = \frac{3IF-IM3}{2} - G_c$$

@ $P_{RF}=-30\text{dBm}$

**Conversion Gain , Noise Figure
vs. RF Frequency**

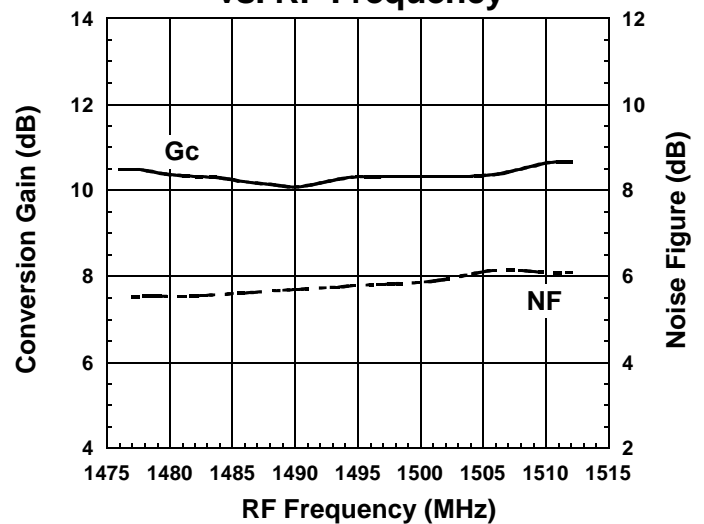

Condition
 $f_{IF}=130\text{MHz}$
 $P_{RF}=-30\text{dBm}$
 $P_{LO}=-10\text{dBm}$
 $V_{MIX}=V_{LO}=2.7\text{V}$
 Upper LOCAL

■ TYPICAL CHARACTERISTICS (Continued)

Conversion Gain vs. V_{MIX} , V_{LO}

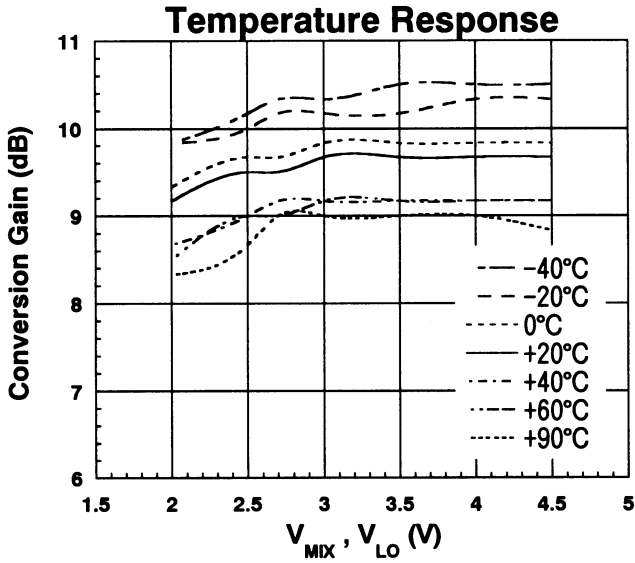

Condition
 $f_{IF}=130\text{MHz}$
 $f_{RF}=1489\text{MHz}, P_{RF}=-30\text{dBm}$
 $f_{LO}=1619\text{MHz}, P_{LO}=-10\text{dBm}$

Noise Figure vs. V_{MIX} , V_{LO}

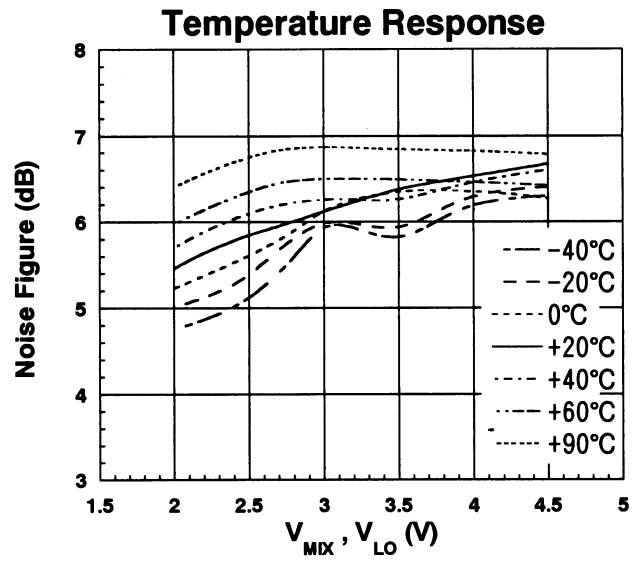

Condition
 $f_{IF}=130\text{MHz}$
 $f_{RF}=1489\text{MHz}$
 $f_{LO}=1619\text{MHz}, P_{LO}=-10\text{dBm}$

Input-IP3 vs. V_{MIX} , V_{LO}

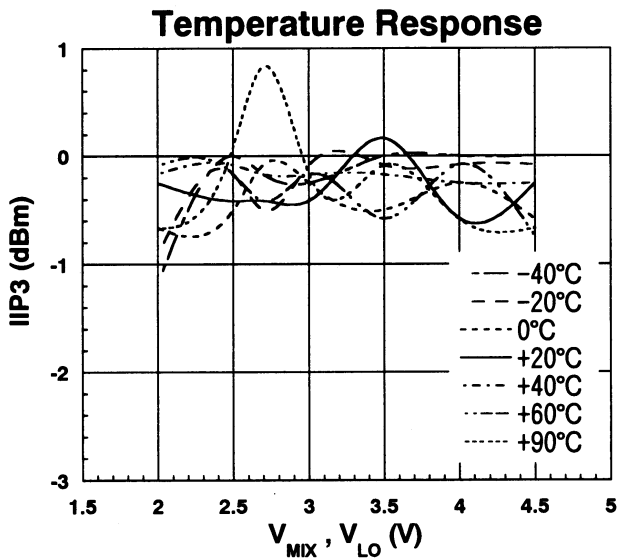

Condition
 $f_{IF}=130\text{MHz}$
 $f_{RF1}=1489.0\text{MHz}, P_{RF}=-30\text{dBm}$
 $f_{RF2}=1489.1\text{MHz}$
 $f_{LO}=1619\text{MHz}, f_{LO}=-10\text{dBm}$

$$IP3 = \frac{3IF-IM3}{2} - G_c$$

@ $P_{RF}=-30\text{dBm}$

TYPICAL CHARACTERISTICS (Continued)

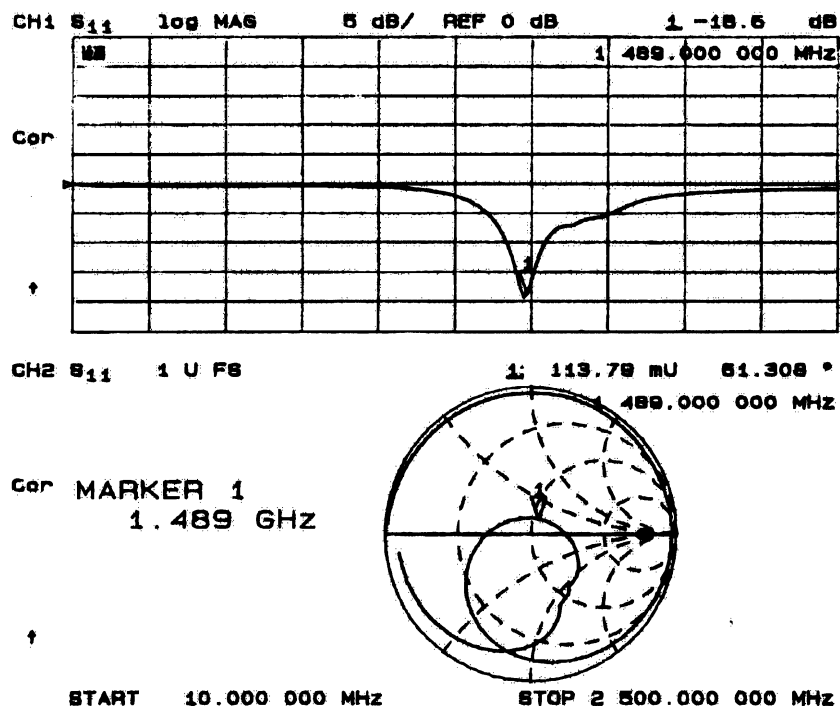

RFIN PORT EXTERNAL MATCHING NETWORK IMPEDANCE PLOT

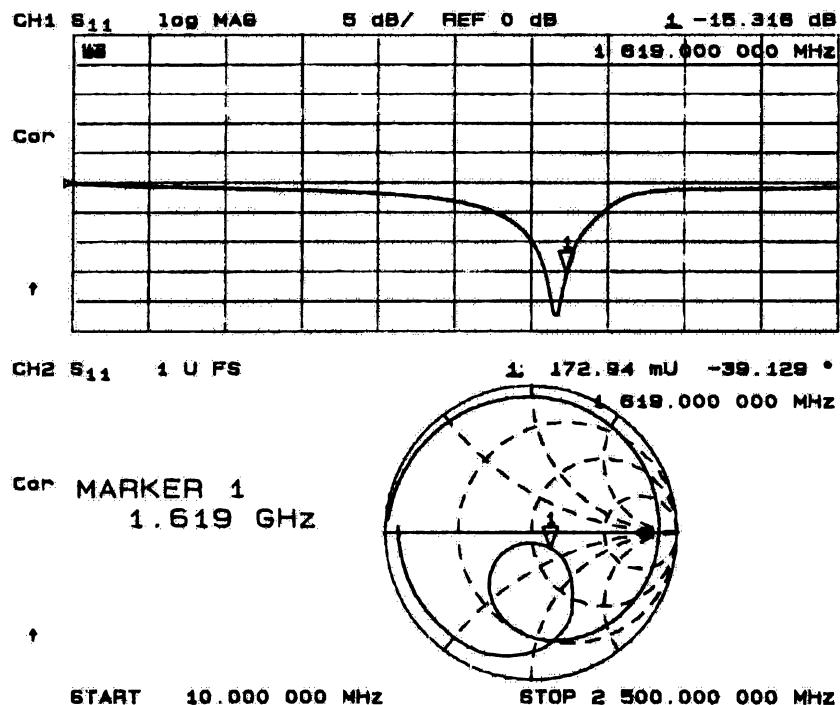

LOIN PORT EXTERNAL MATCHING NETWORK IMPEDANCE PLOT

NJG1553F

TYPICAL CHARACTERISTICS (Continued)

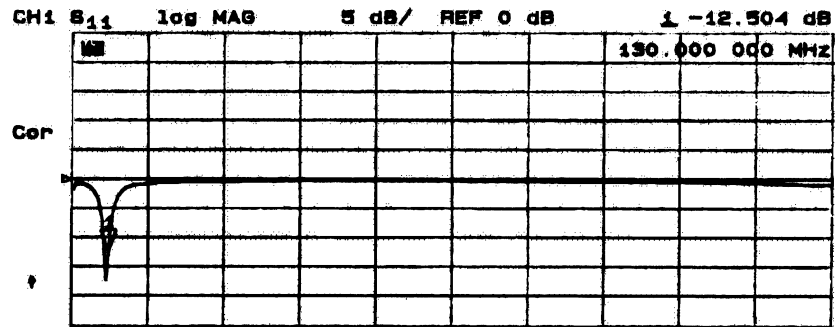

CH2 S₁₁ 1 U F8 1: 225.72 mU 149.97 °
 130.000 000 MHz

Cor MARKER 1
 130 MHz

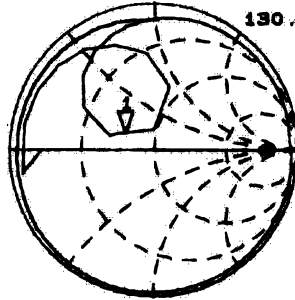

START 10.000 000 MHz STOP 2 500.000 000 MHz

IFOUT PORT EXTERNAL MATCHING NETWORK IMPEDANCE PLOT

■ TYPICAL CHARACTERISTICS (Application 1 1.9GHz, $f_{LO}=1660\text{MHz}$)

Conversion Gain , Noise Figure vs. LO Power

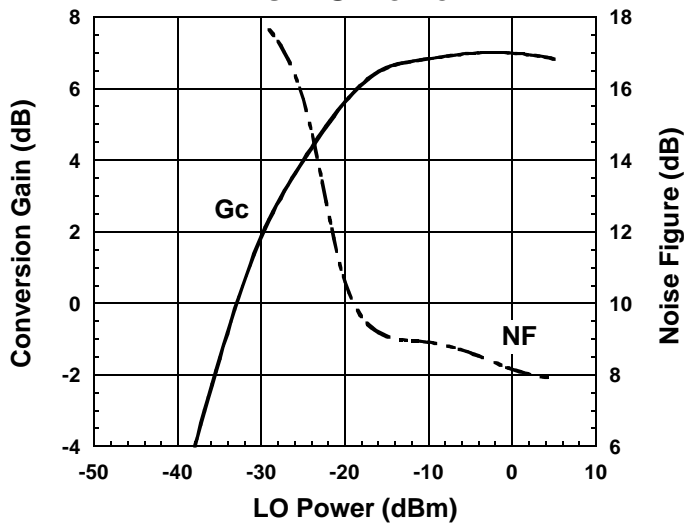

Condition
 $f_{IF}=240\text{MHz}$
 $f_{RF}=1900\text{MHz}, P_{RF}=-30\text{dBm}$
 $f_{LO}=1660\text{MHz}$
 $V_{MIX}=V_{LO}=2.7\text{V}$

IF , IM3 , IM5 vs. RF Power

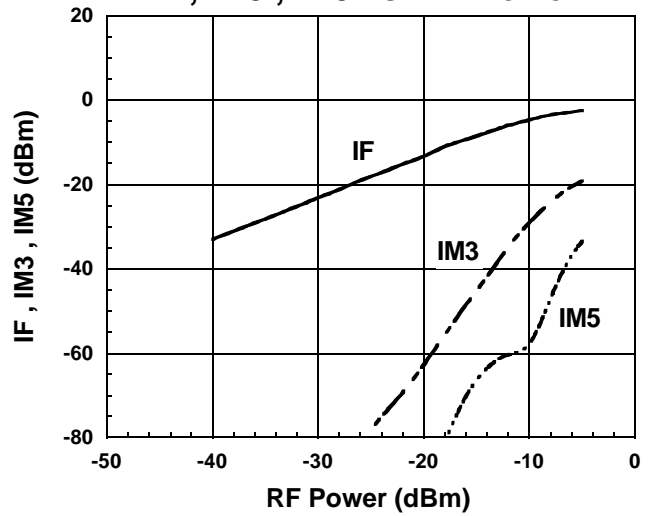

Condition
 $f_{IF}=240\text{MHz}$
 $f_{RF1}=1900.0\text{MHz}$
 $f_{RF2}=1900.1\text{MHz}$
 $f_{LO}=1660\text{MHz}, P_{LO}=-10\text{dBm}$
 $V_{MIX}=V_{LO}=2.7\text{V}$

Input-IP3 vs. LO Power

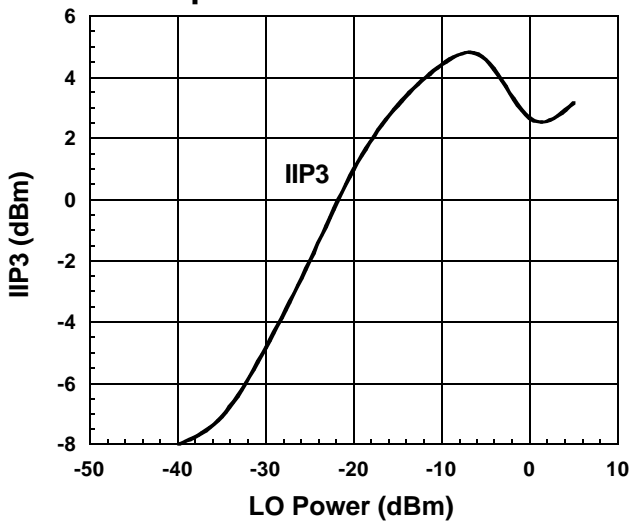

Condition
 $f_{IF}=240\text{MHz}$
 $f_{RF1}=1900.0\text{MHz}, P_{RF}=-25\text{dBm}$
 $f_{RF2}=1900.1\text{MHz}$
 $f_{LO}=1660\text{MHz}$
 $V_{MIX}=V_{LO}=2.7\text{V}$

$$IIP3 = \frac{3IF - IM3}{2} - G_c$$
 @ $P_{RF} = -25\text{dBm}$

Conversion Gain , Noise Figure , Input-IP3 vs. V_{MIX}, V_{LO}

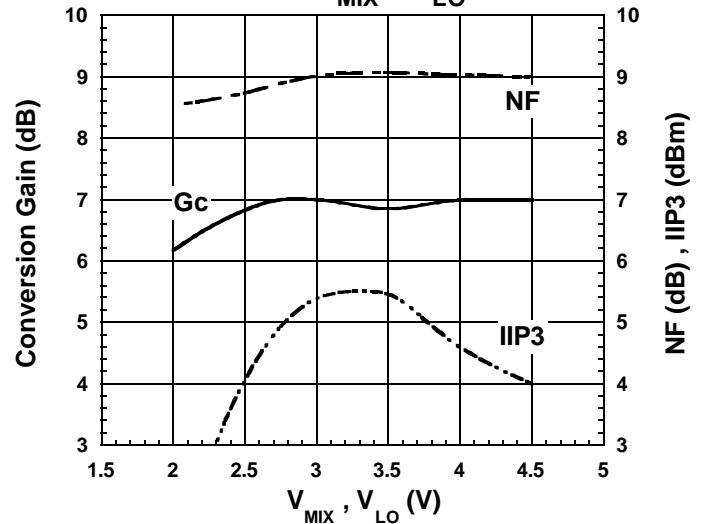

Condition
 $f_{IF}=240\text{MHz}$
 $f_{RF1}=1900.0\text{MHz}, P_{RF}=-30\text{dBm}$
 $f_{RF2}=1900.1\text{MHz}$
 $f_{LO}=1660\text{MHz}, P_{LO}=-10\text{dBm}$

$$IIP3 = \frac{3IF - IM3}{2} - G_c$$
 @ $P_{RF} = -25\text{dBm}$

NJG1553F

TYPICAL CHARACTERISTICS (Continued)

Conversion Gain vs. LO Power Temperature Response

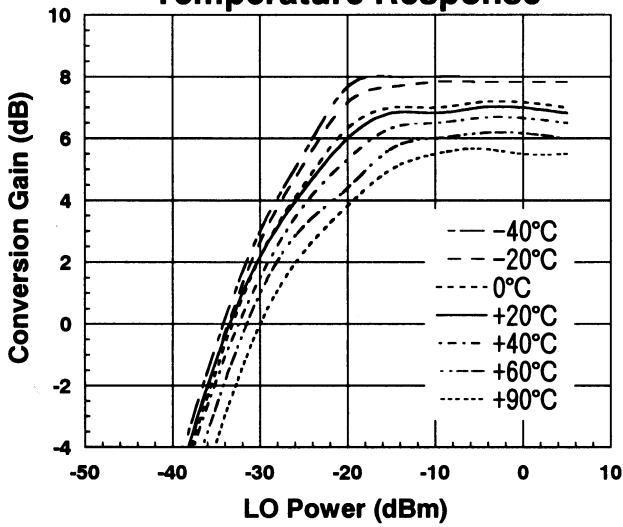

Condition
 $f_{IF}=240\text{MHz}$
 $f_{RF}=1900\text{MHz}, P_{RF}=-30\text{dBm}$
 $f_{LO}=1660\text{MHz}$
 $V_{MIX}=V_{LO}=2.7\text{V}$

Noise Figure vs. LO Power Temperature Response

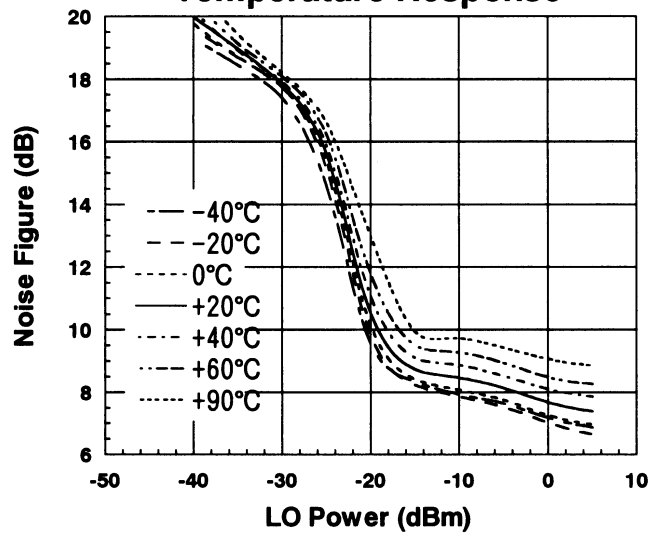

Condition
 $f_{IF}=240\text{MHz}$
 $f_{RF}=1900\text{MHz}$
 $f_{LO}=1660\text{MHz}$
 $V_{MIX}=V_{LO}=2.7\text{V}$

Input-IP3 vs. LO Power Temperature Response

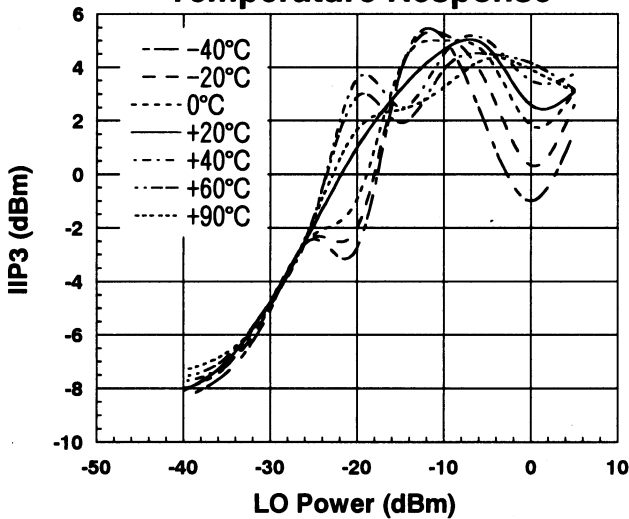

Condition
 $f_{IF}=240\text{MHz}$
 $f_{RF1}=1900.0\text{MHz}, P_{RF}=-25\text{dBm}$
 $f_{RF2}=1900.1\text{MHz}$
 $f_{LO}=1660\text{MHz}$
 $V_{MIX}=V_{LO}=2.7\text{V}$

$$IIP3 = \frac{3IF-IM3}{2} - G_c$$

@ $P_{RF}=-25\text{dBm}$

Conversion Gain , Noise Figure vs. RF Frequency

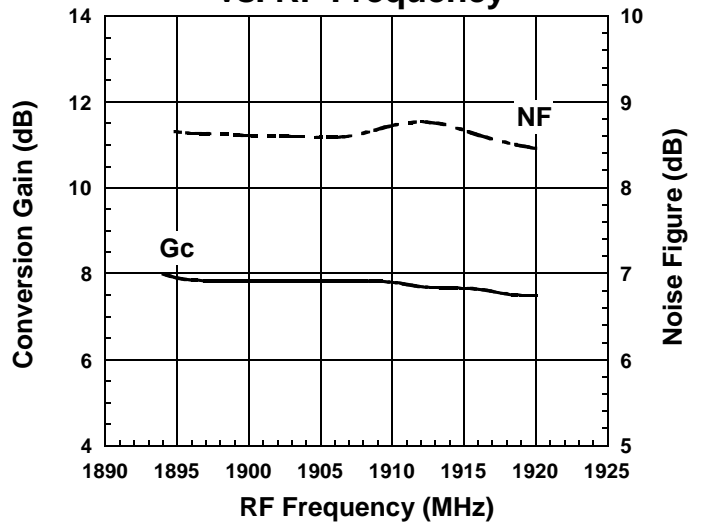

Condition
 $f_{IF}=240\text{MHz}$
 $P_{RF}=-30\text{dBm}$
 $P_{LO}=-10\text{dBm}$
 $V_{MIX}=V_{LO}=2.7\text{V}$
 Lower LOCAL

■ TYPICAL CHARACTERISTICS (Continued)

Conversion Gain vs. V_{MIX}, V_{LO}

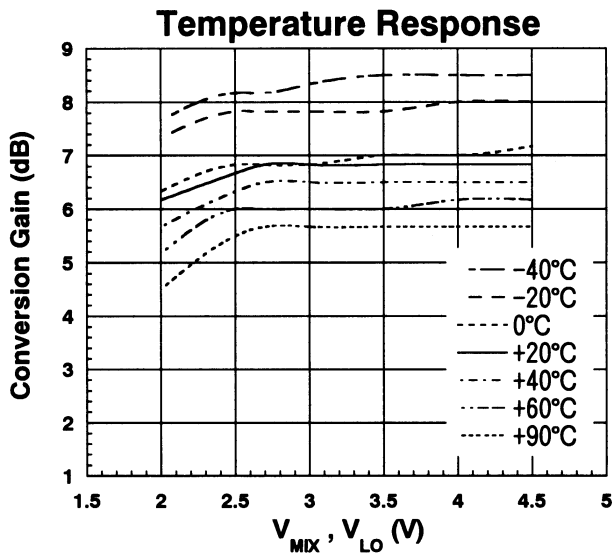

Condition
 $f_{IF}=240\text{MHz}$
 $f_{RF}=1900\text{MHz}, P_{RF}=-30\text{dBm}$
 $f_{LO}=1660\text{MHz}, P_{LO}=-10\text{dBm}$

Noise Figure vs. V_{MIX}, V_{LO}

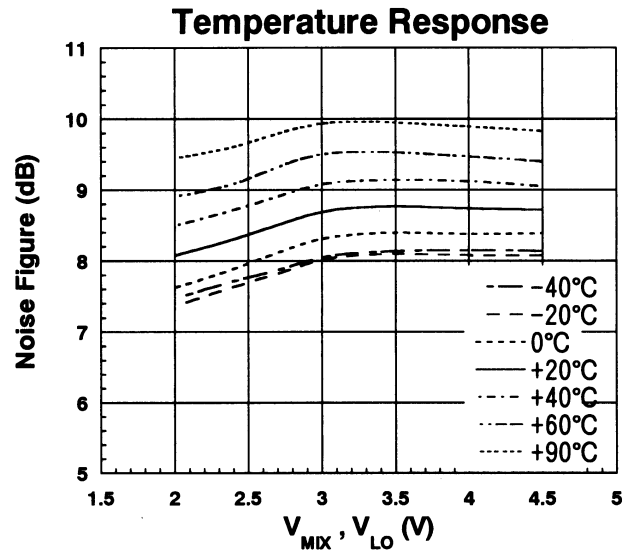

Condition
 $f_{IF}=240\text{MHz}$
 $f_{RF}=1900\text{MHz}$
 $f_{LO}=1660\text{MHz}, P_{LO}=-10\text{dBm}$

Input-IP3 vs. V_{MIX}, V_{LO}

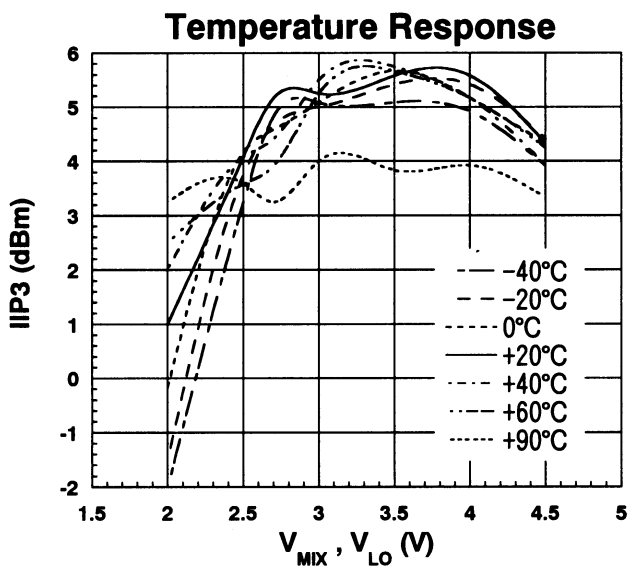

Condition
 $f_{IF}=240\text{MHz}$
 $f_{RF1}=1900.0\text{MHz}, P_{RF}=-25\text{dBm}$
 $f_{RF2}=1900.1\text{MHz}$
 $f_{LO}=1660\text{MHz}, P_{LO}=-10\text{dBm}$

$$IIP3 = \frac{3IF-IM3}{2} - G_c$$
 @ $P_{RF}=-25\text{dBm}$

NJG1553F

TYPICAL CHARACTERISTICS (Continued)

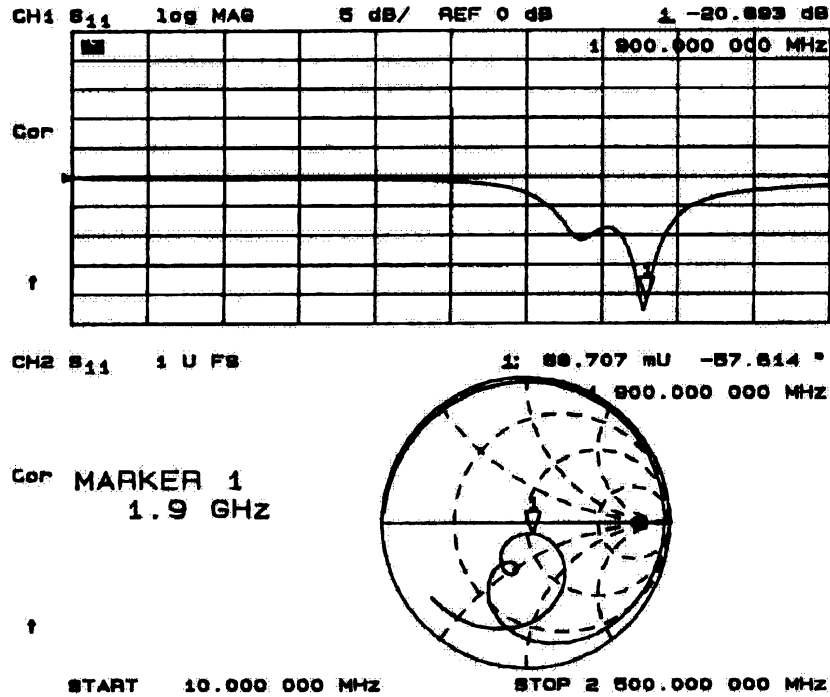

RFIN PORT EXTERNAL MATCHING NETWORK IMPEDANCE PLOT

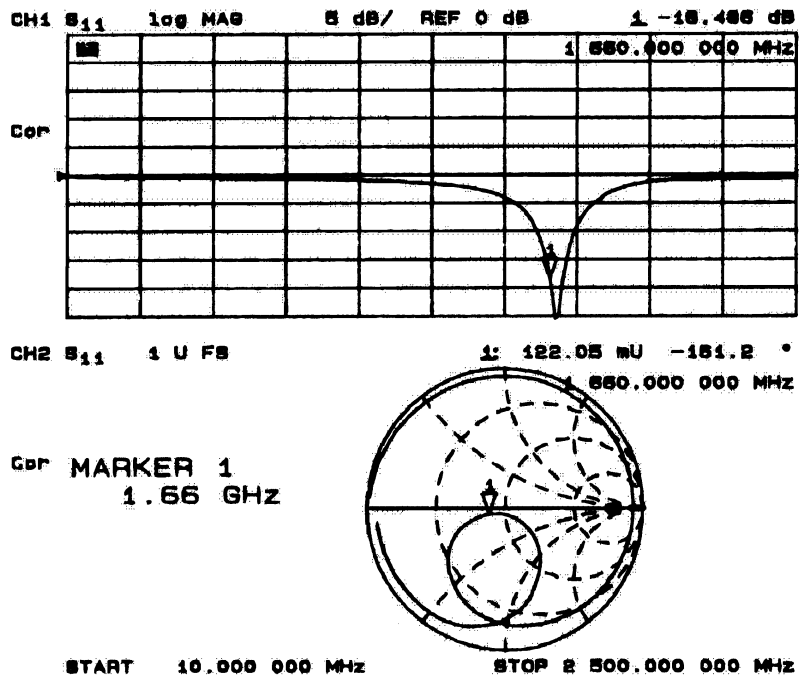

LOIN PORT EXTERNAL MATCHING NETWORK IMPEDANCE PLOT

TYPICAL CHARACTERISTICS (Continued)

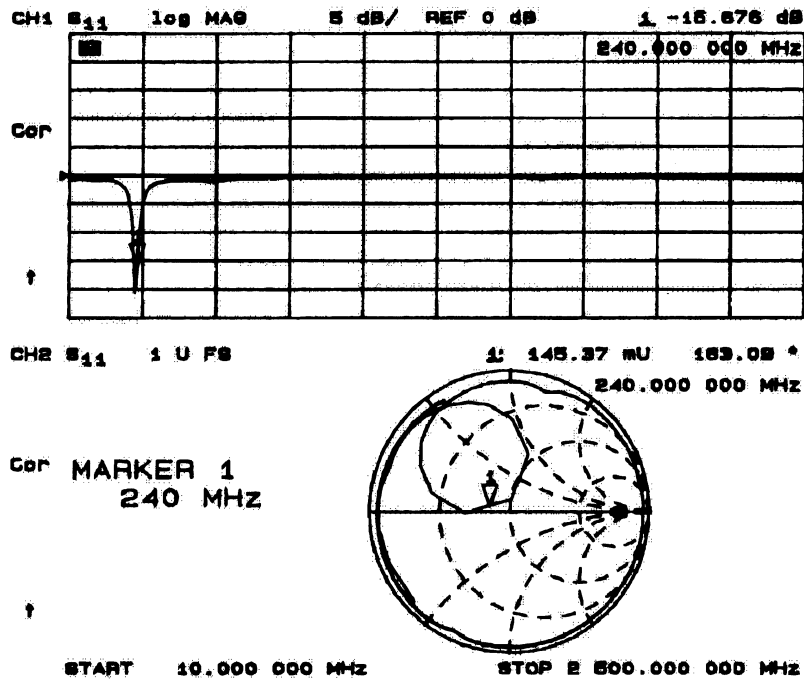

IFOUT PORT EXTERNAL MATCHING NETWORK IMPEDANCE PLOT

TYPICAL CHARACTERISTICS (Application 1 1.9GHz, $f_{LO}=2110\text{MHz}$)

Conversion Gain , Noise Figure vs. RF Frequency

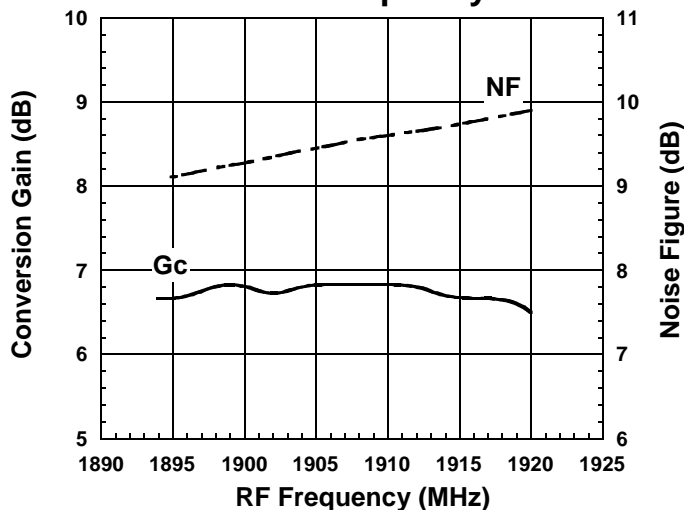

Condition
 $f_{IF}=210\text{MHz}$
 $P_{RF}=-30\text{dBm}$
 $P_{LO}=-10\text{dBm}$
 $V_{MIX}=V_{LO}=2.7\text{V}$
 Upper LOCAL

IF , IM3 vs. RF Power

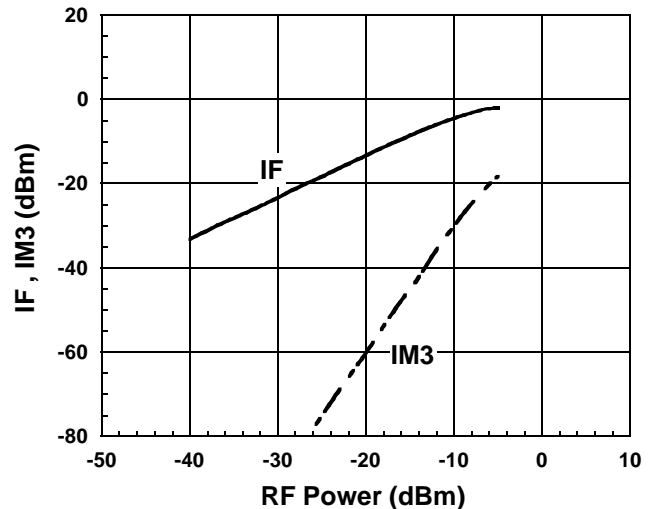

Condition
 $f_{IF}=210\text{MHz}$
 $f_{RF1}=1900.0\text{MHz}$
 $f_{RF2}=1900.1\text{MHz}$
 $f_{LO}=2110\text{MHz}, P_{LO}=-10\text{dBm}$
 $V_{MIX}=V_{LO}=2.7\text{V}$

NJG1553F

■ TYPICAL CHARACTERISTICS (Application 1 1.9GHz, $f_{LO}=1634.62\text{MHz}$)

Conversion Gain , Noise Figure vs. LO Power

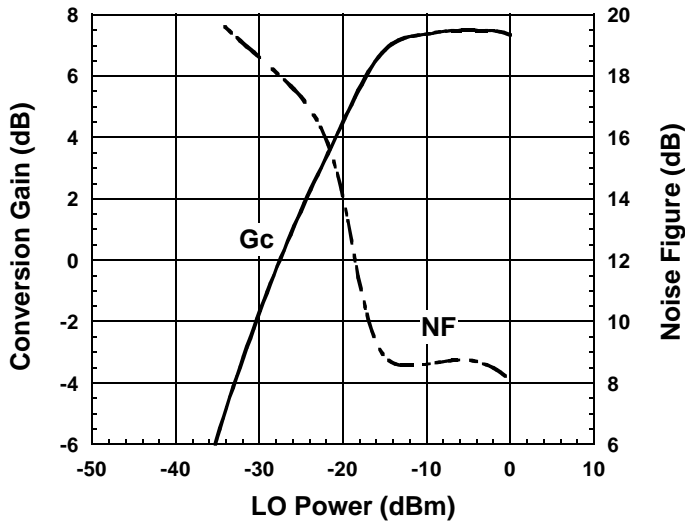

Condition
 $f_{IF}=220.38\text{MHz}$
 $f_{RF}=1855\text{MHz}, P_{RF}=-30\text{dBm}$
 $f_{LO}=1634.62\text{MHz}$
 $V_{MIX}=V_{LO}=2.7\text{V}$

IF , IM3 vs. RF Power

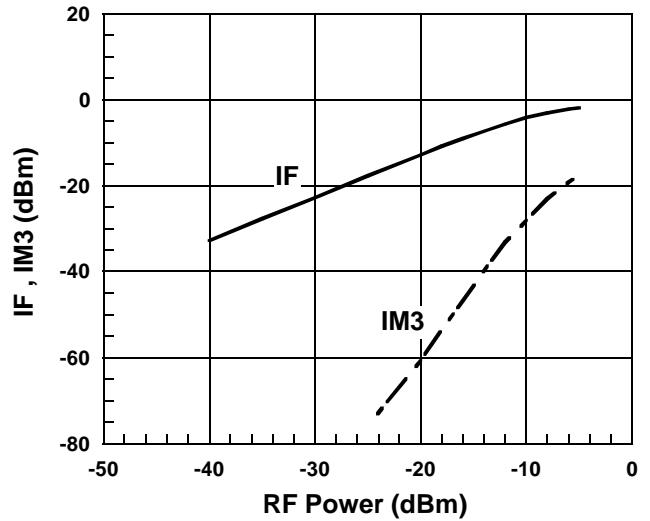

Condition
 $f_{IF}=220.38\text{MHz}$
 $f_{RF1}=1855.0\text{MHz}$
 $f_{RF2}=1855.1\text{MHz}$
 $f_{LO}=1634.62\text{MHz}, P_{LO}=-10\text{dBm}$
 $V_{MIX}=V_{LO}=2.7\text{V}$

■ TYPICAL CHARACTERISTICS (Application 1 1.9GHz, $f_{LO}=1749.62\text{MHz}$)

Conversion Gain vs. LO Power

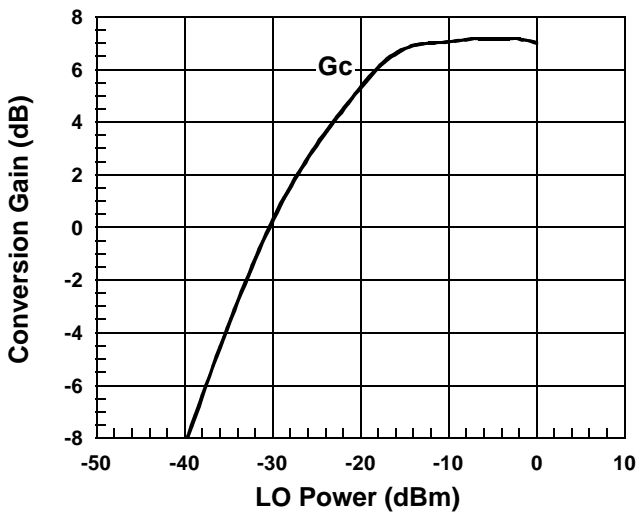

Condition
 $f_{IF}=210.38\text{MHz}$
 $f_{RF}=1960\text{MHz}, P_{RF}=-30\text{dBm}$
 $f_{LO}=1749.62\text{MHz}$
 $V_{MIX}=V_{LO}=2.7\text{V}$

IF , IM3 vs. RF Power

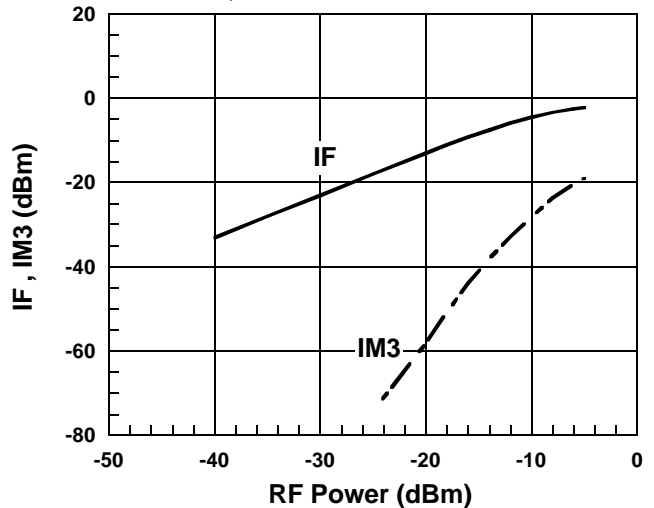

Condition
 $f_{IF}=210.38\text{MHz}$
 $f_{RF1}=1960.0\text{MHz}$
 $f_{RF2}=1960.1\text{MHz}$
 $f_{LO}=1749.62\text{MHz}, P_{LO}=-10\text{dBm}$
 $V_{MIX}=V_{LO}=2.7\text{V}$

■ TYPICAL CHARACTERISTICS (Application 1 2.1GHz, $f_{LO}=1914.62\text{MHz}$)

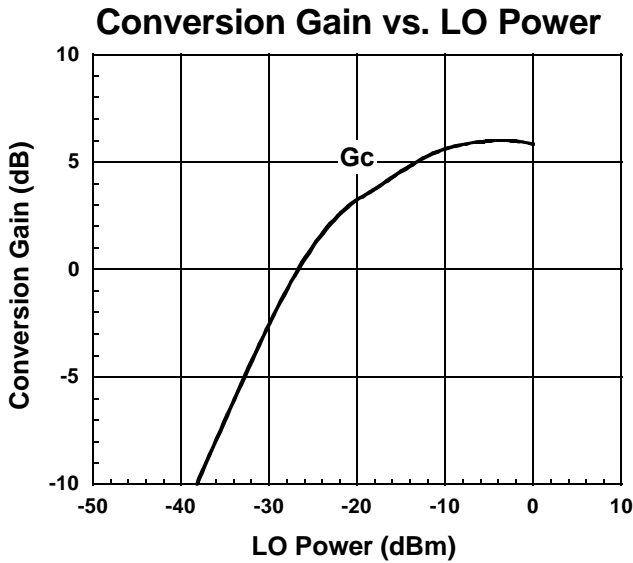

Condition
 $f_{IF}=220.38\text{MHz}$
 $f_{RF}=2135\text{MHz}, P_{RF}=-30\text{dBm}$
 $f_{LO}=1914.62\text{MHz}$
 $V_{MIX}=V_{LO}=2.7\text{V}$

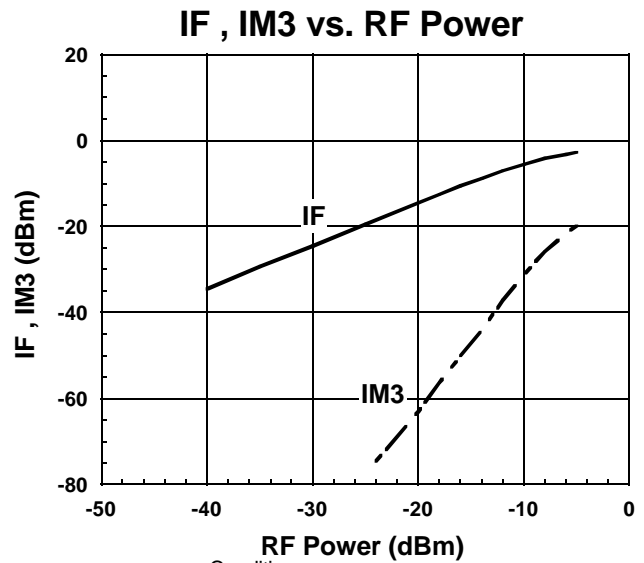

Condition
 $f_{IF}=220.38\text{MHz}$
 $f_{RF1}=2135.0\text{MHz}$
 $f_{RF2}=2135.1\text{MHz}$
 $f_{LO}=1914.62\text{MHz}, P_{LO}=-10\text{dBm}$
 $V_{MIX}=V_{LO}=2.7\text{V}$

■ TYPICAL CHARACTERISTICS (Application 2 1.9GHz, $f_{LO}=2110\text{MHz}$)

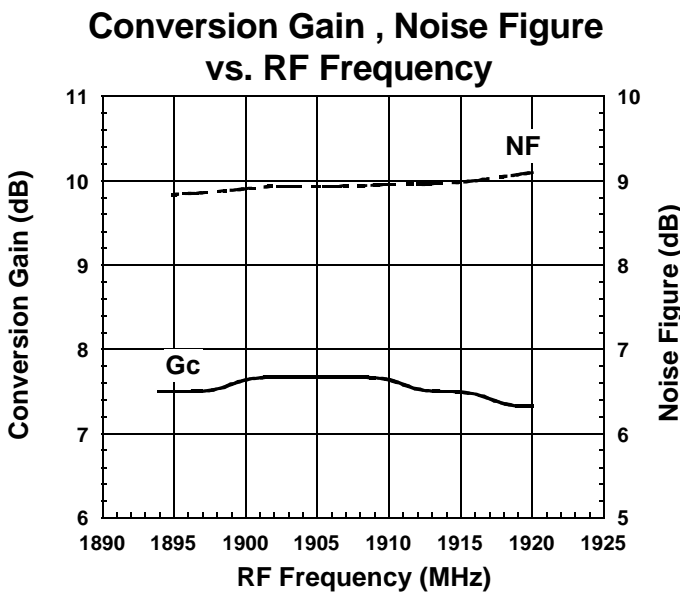

Condition
 $f_{IF}=210\text{MHz}$
 $P_{RF}=-30\text{dBm}$
 $P_{LO}=-10\text{dBm}$
 $V_{MIX}=V_{LO}=2.7\text{V}$
 Upper LOCAL

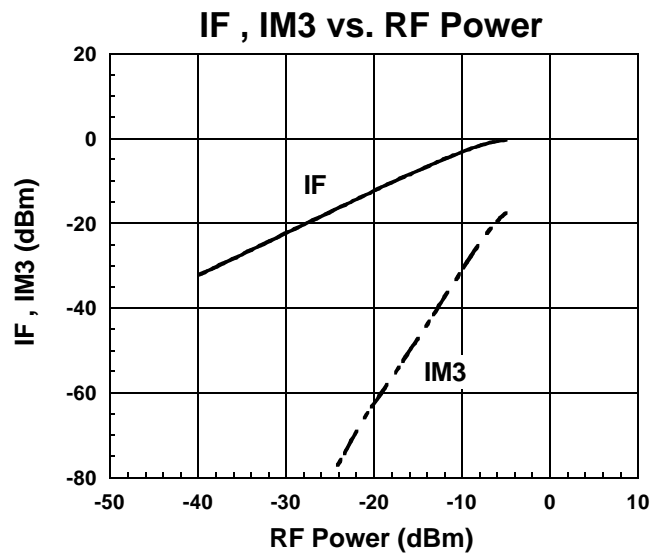

Condition
 $f_{IF}=210\text{MHz}$
 $f_{RF1}=1900.0\text{MHz}$
 $f_{RF2}=1900.1\text{MHz}$
 $f_{LO}=2110\text{MHz}, P_{LO}=-10\text{dBm}$
 $V_{MIX}=V_{LO}=2.7\text{V}$

NJG1553F

APPLICATION CIRCUIT 1

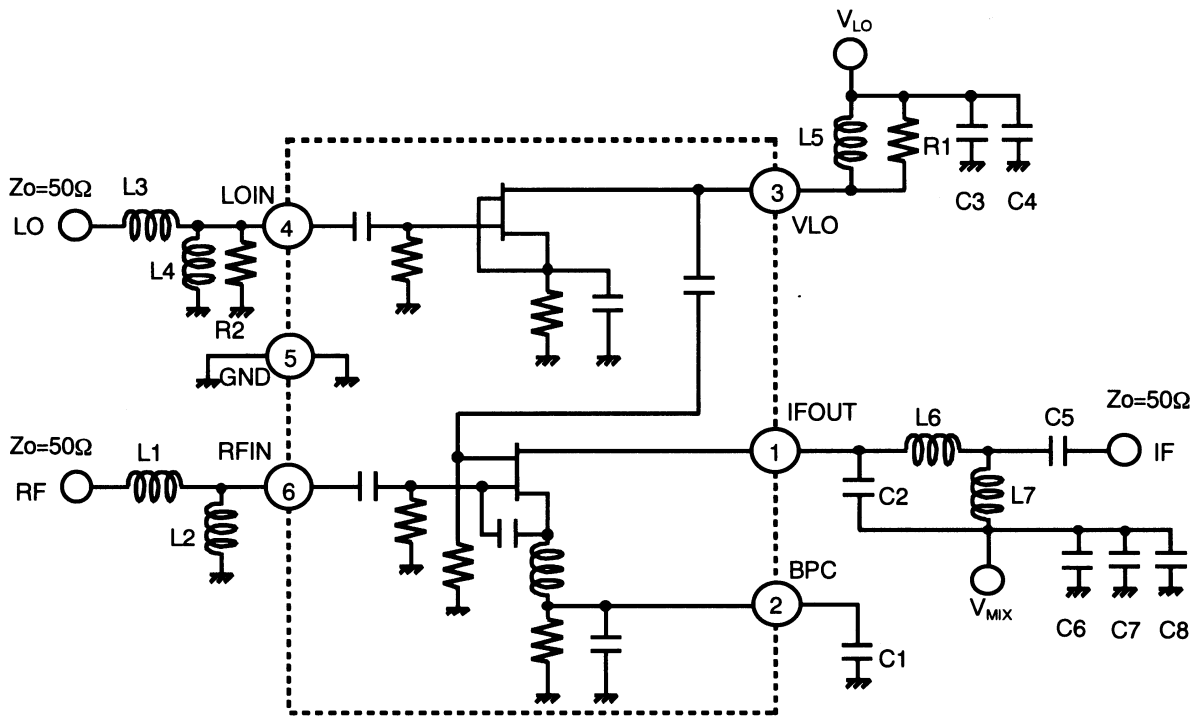

PARTS LIST 1

PART ID	1.5GHz Band		1.9GHz BAND		COMMENT
	Upper LOCAL	Lower LOCAL	Upper LOCAL		
	$f_{LO}=1619\text{MHz}$ $f_{IF}=130\text{MHz}$	$f_{LO}=1660\text{MHz}$ $f_{IF}=240\text{MHz}$	$f_{LO}=2110\text{MHz}$ $f_{IF}=210\text{MHz}$		
L1	10nH	6.8nH	4.7nH	TAIYO-YUDEN(HK1608)	
L2	8.2nH	4.7nH	3.3nH	TAIYO-YUDEN(HK1608)	
L3	12nH	12nH	6.8nH	TAIYO-YUDEN(HK1608)	
L4	12nH	10nH	5.6nH	TAIYO-YUDEN(HK1608)	
L5	6.8nH	5.6nH	3.9nH	TAIYO-YUDEN(HK1608)	
L6	100nH	39nH	47nH	TAIYO-YUDEN(HK1608)	
L7	47nH	15nH	27nH	TAIYO-YUDEN(HK1608)	
C1	1000pF	560pF	560pF	MURATA(GRM39)	
C2	11pF	8pF	8pF	MURATA(GRM39)	
C3	100pF	100pF	100pF	MURATA(GRM39)	
C4	100pF	100pF	100pF	MURATA(GRM39)	
C5	1000pF	1000pF	1000pF	MURATA(GRM39)	
C6	10pF	10pF	10pF	MURATA(GRM39)	
C7	100pF	100pF	100pF	MURATA(GRM39)	
C8	1000pF	1000pF	1000pF	MURATA(GRM39)	
R1	270Ω	270Ω	240Ω	TAMA Electronics(CRG16G)	
R2	270Ω	470Ω	430Ω	TAMA Electronics(CRG16G)	

APPLICATION CIRCUIT 1

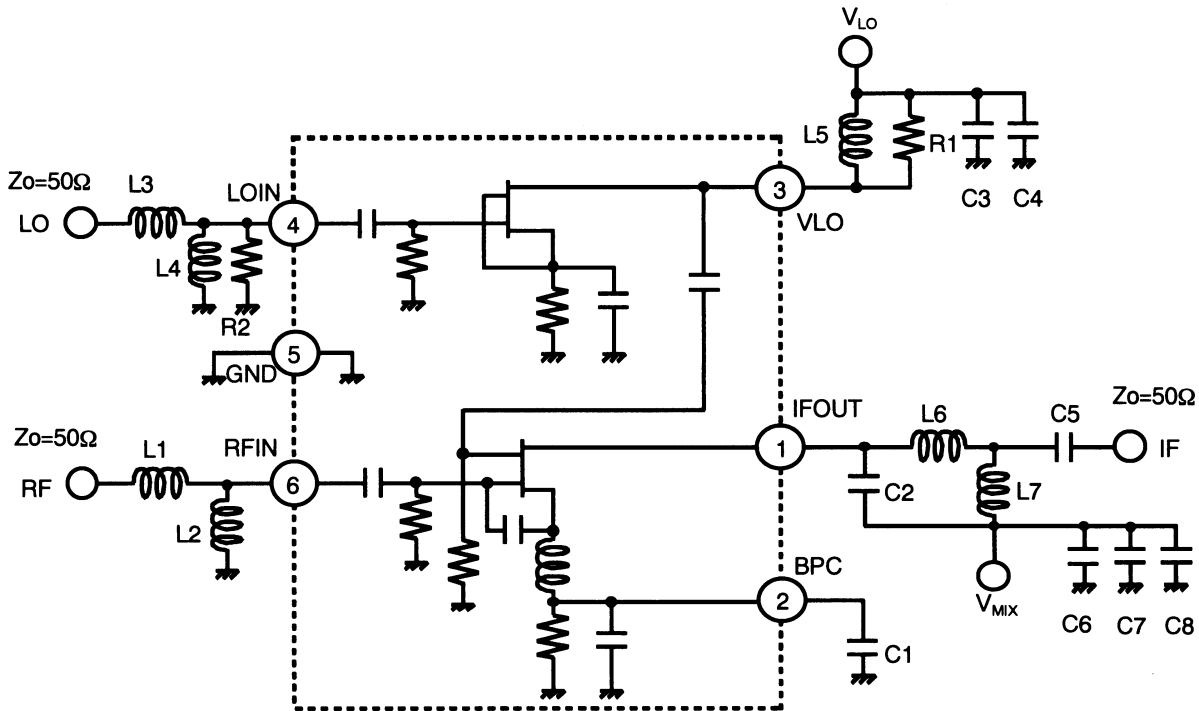

PARTS LIST 2

PART ID	1.9GHz Band		2.1GHz Band	COMMENT
	Lower LOCAL	Lower LOCAL	Lower LOCAL	
	$f_{LO}=1634.62\text{MHz}$ $f_{IF}=220.38\text{MHz}$	$f_{LO}=1749.62\text{MHz}$ $f_{IF}=210.38\text{MHz}$	$f_{LO}=1914.62\text{MHz}$ $f_{IF}=220.38\text{MHz}$	
L1	6.8nH	6.8nH	4.7nH	TAIYO-YUDEN(HK1608)
L2	4.7nH	4.7nH	3.9nH	TAIYO-YUDEN(HK1608)
L3	12nH	12nH	10nH	TAIYO-YUDEN(HK1608)
L4	10nH	8.2nH	6.8nH	TAIYO-YUDEN(HK1608)
L5	6.8nH	5.6nH	4.7nH	TAIYO-YUDEN(HK1608)
L6	39nH	39nH	39nH	TAIYO-YUDEN(HK1608)
L7	22nH	22nH	22nH	TAIYO-YUDEN(HK1608)
C1	560pF	560pF	560pF	MURATA(GRM39)
C2	8pF	8pF	8pF	MURATA(GRM39)
C3	10pF	10pF	10pF	MURATA(GRM39)
C4	100pF	100pF	100pF	MURATA(GRM39)
C5	1000pF	1000pF	1000pF	MURATA(GRM39)
C6	10pF	10pF	10pF	MURATA(GRM39)
C7	100pF	100pF	100pF	MURATA(GRM39)
C8	1000pF	1000pF	1000pF	MURATA(GRM39)
R1	240Ω	270Ω	330Ω	TAMA Electronics(CRG16G)
R2	430Ω	390Ω	470Ω	MURATA(GRM39)

NJG1553F

APPLICATION CIRCUIT 2

This circuit is purposed for improving input IP3 performance by setting mixer current to around 10mA by adding external resistance to BPC terminal.

Reference value Application 1 IIP3=+4dBm
 Application 2 IIP3=+5.1dBm

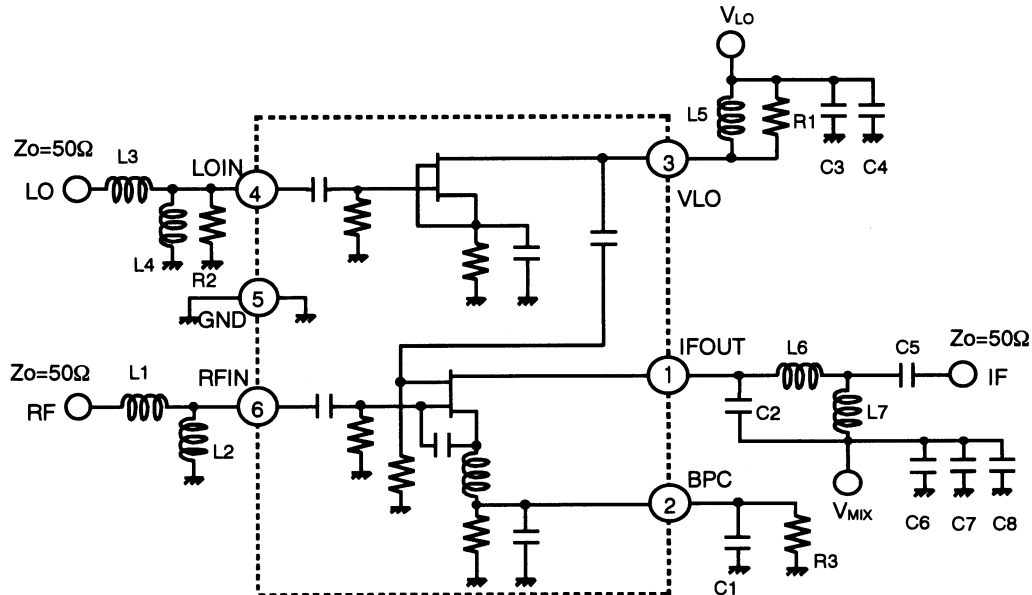

PARTS LIST

PART ID	1.9GHz Band	COMMENT
	Upper LOCAL f _{LO} =2110MHz f _{IF} =210MHz	
L1	4.7nH	TAIYO-YUDEN(HK1608)
L2	3.3nH	TAIYO-YUDEN(HK1608)
L3	6.8nH	TAIYO-YUDEN(HK1608)
L4	4.7nH	TAIYO-YUDEN(HK1608)
L5	3.9nH	TAIYO-YUDEN(HK1608)
L6	47nH	TAIYO-YUDEN(HK1608)
L7	27nH	TAIYO-YUDEN(HK1608)
C1	560pF	MURATA(GRM39)
C2	8pF	MURATA(GRM39)
C3	100pF	MURATA(GRM39)
C4	1000pF	MURATA(GRM39)
C5	1000pF	MURATA(GRM39)
C6	10pF	MURATA(GRM39)
C7	100pF	MURATA(GRM39)
C8	1000pF	MURATA(GRM39)
R1	240Ω	TAMA Electronics(CRG16G)
R2	430Ω	TAMA Electronics(CRG16G)
R3	82Ω	TAMA Electronics(CRG16G)

RECOMMENDED PCB DESIGN

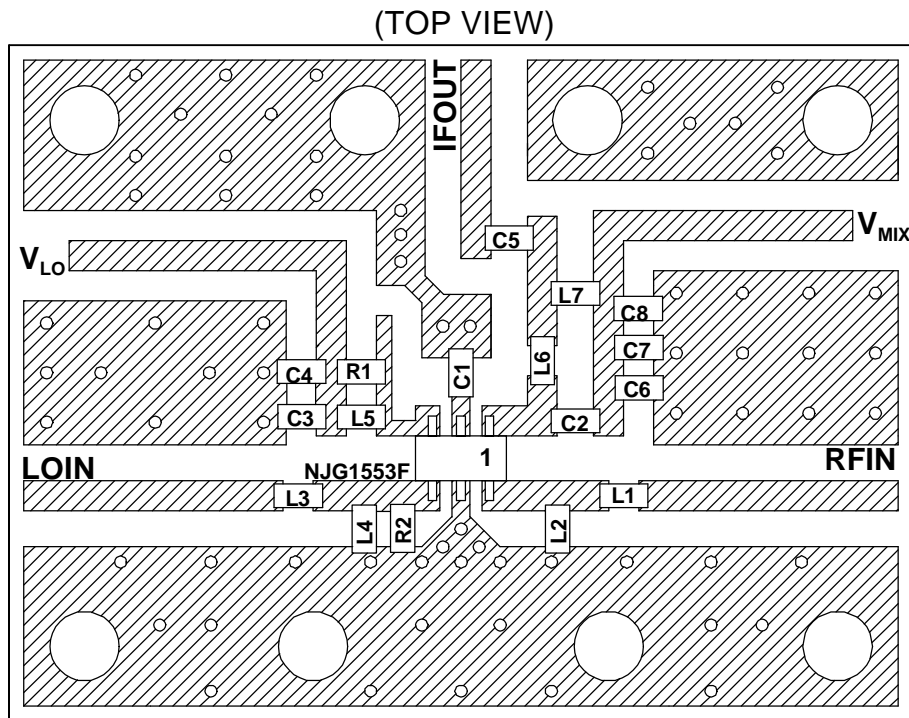

(SIZE: 22.5mm x 30mm)

PRECAUTIONS

- [1] Please locate L5 and R1 close to VLO terminal (3).
- [2] Distance from L1 and RFIN terminal (6) is 3.5mm.
- [3] Distance from L3 and LOIN terminal (4) is 3.5mm.
- [4] Please locate C1 close to BPC terminal (2).
- [5] Please locate C6, C7, C8 close to C2, L7.
- [6] Please locate C3, C4 close to R1, L5.

MEASURING BLOCK DIAGRAM

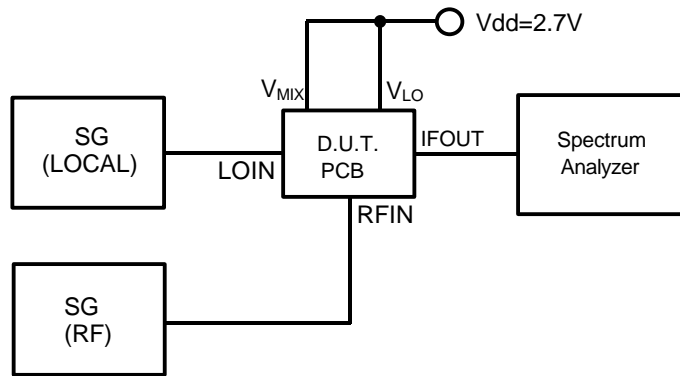

Conversion Gain Measurement Block Diagram

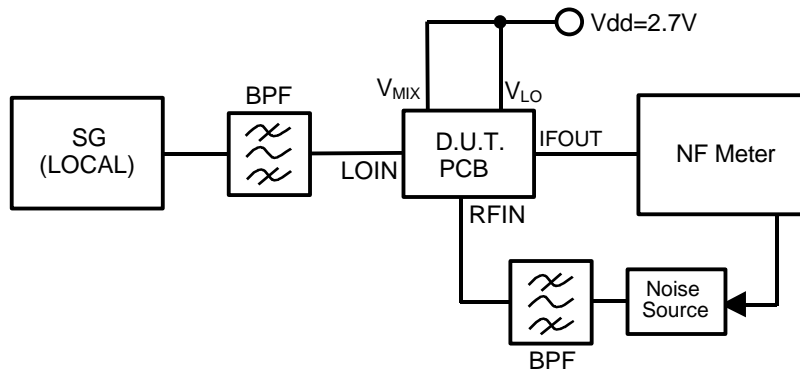

Noise Figure Measurement Block Diagram

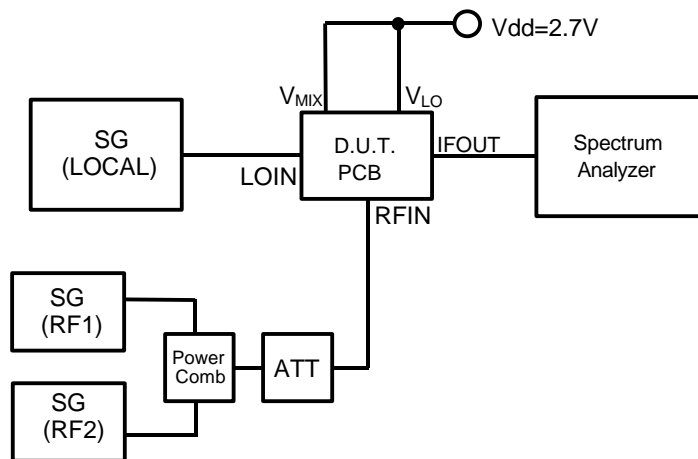

IF, IM3, IM5 Measurement Block Diagram

■PACKAGE OUTLINE (MTP6)

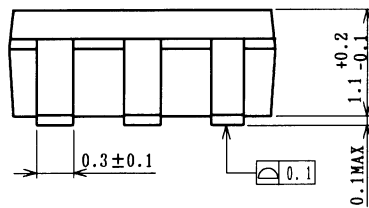
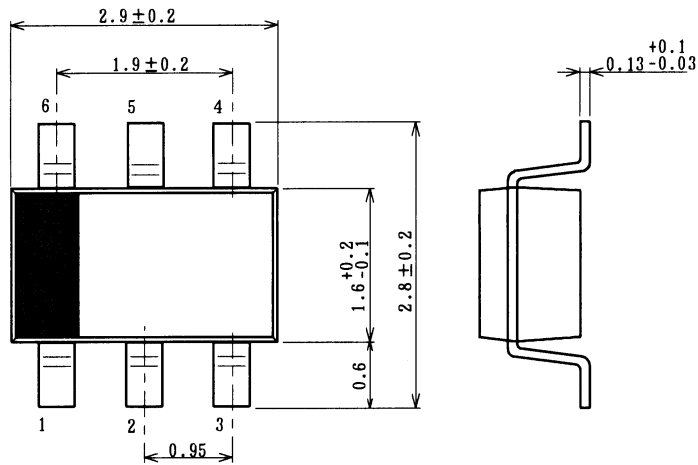

Lead material	: Copper
Lead surface finish	: Solder plating
Molding material	: Epoxy resin
Unit	: mm
Weight	: 14mg

Cautions on using this product

This product contains Gallium-Arsenide (GaAs) which is a harmful material.

- Do NOT eat or put into mouth.
- Do NOT dispose in fire or break up this product.
- Do NOT chemically make gas or powder with this product.
- To waste this product, please obey the relating law of your country.

[CAUTION]

The specifications on this databook are only given for information, without any guarantee as regards either mistakes or omissions. The application circuits in this databook are described only to show representative usages of the product and not intended for the guarantee or permission of any right including the industrial rights.

This product may be damaged with electric static discharge (ESD) or spike voltage. Please handle with care to avoid these damages.