

# TPD2005F

## HIGH-SIDE POWER SWITCH ARRAY (8 CHANNELS) for MOTORS, SOLENOIDS, and LAMP DRIVES

The TPD2005F is an 8-channel high-side switch array for vertical power MOS FET output. A monolithic power IC, it can directly drive a power load from a CMOS or TTL logic circuit (such as an MPU). It offers overcurrent and overtemperature protection functions.

### FEATURES

- A high-side switch array incorporating an N-channel power MOS FET (1.2 Ω max.) and an 8-channel charge pump.
- Can directly drive a power load from a microprocessor.
- Built-in protection against overtemperature protection and overcurrent protection.
- 8-channel access enables space-saving design.
- High operating voltage : 40 V
- Low on-resistance : 1.2 Ω max. @V<sub>DD</sub> = 12 V, I<sub>O</sub> = 0.5 A (per channel)
- Supports parallel operation.
- Low operating current : 5 mA max. @V<sub>DD</sub> = 40 V, V<sub>IN</sub> = 0 V
- Supplied in an SSOP-24 package (300 mil) in embossed taping.

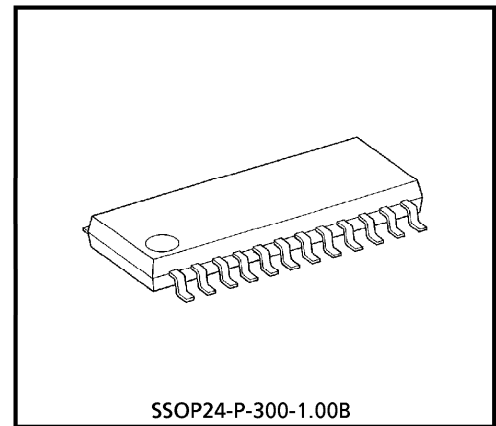

SSOP24-P-300-1.00B

Weight : 0.29 g (typ.)

### PIN ASSIGNMENT

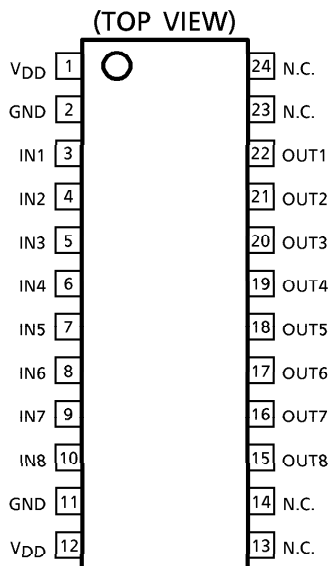

### MARKING

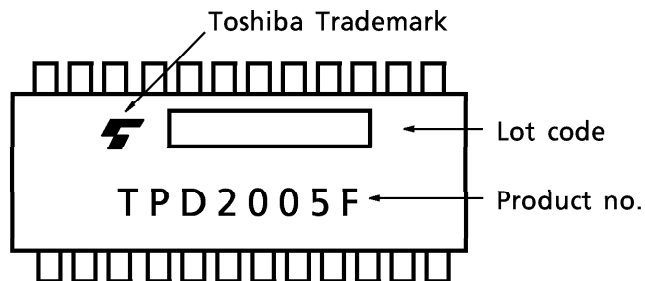

#### Lot code naming system

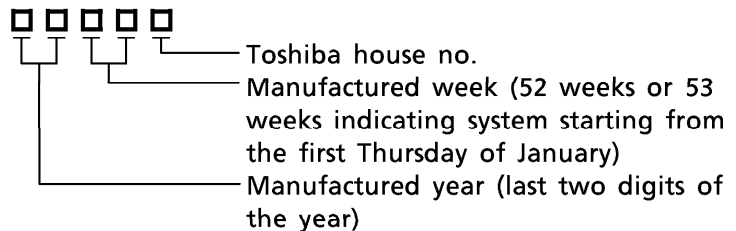

This device uses MOS structure, it is sensitive to electrostatics. Please take this into account.

980910EBA2

- TOSHIBA is continually working to improve the quality and the reliability of its products. Nevertheless, semiconductor devices in general can malfunction or fail due to their inherent electrical sensitivity and vulnerability to physical stress. It is the responsibility of the buyer, when utilizing TOSHIBA products, to observe standards of safety, and to avoid situations in which a malfunction or failure of a TOSHIBA product could cause loss of human life, bodily injury or damage to property. In developing your designs, please ensure that TOSHIBA products are used within specified operating ranges as set forth in the most recent products specifications. Also, please keep in mind the precautions and conditions set forth in the TOSHIBA Semiconductor Reliability Handbook.
- The products described in this document are subject to the foreign exchange and foreign trade laws.
- The information contained herein is presented only as a guide for the applications of our products. No responsibility is assumed by TOSHIBA CORPORATION for any infringements of intellectual property or other rights of the third parties which may result from its use. No license is granted by implication or otherwise under any intellectual property or other rights of TOSHIBA CORPORATION or others.
- The information contained herein is subject to change without notice.

BLOCK DIAGRAM

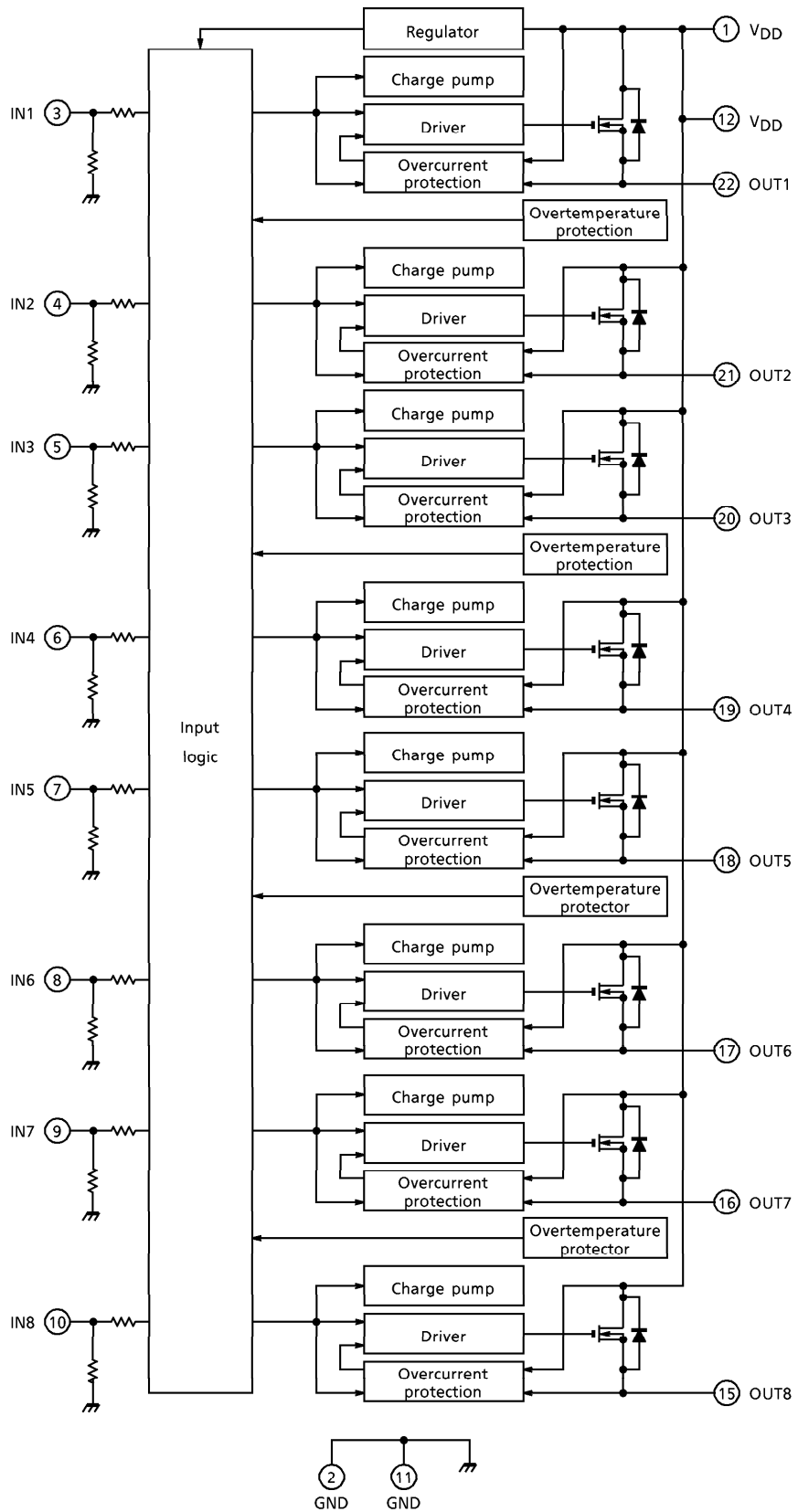

**PIN DESCRIPTION**

PIN No.	SYMBOL	DESCRIPTION
1	V <sub>DD</sub>	Power supply pin; in common with the pin no.12 internally.
2	GND	GND pin; in common with the pin no.11 internally.
3	IN1	Control input pin for channel 1 and built-in pull-down resistor (100 kΩ typ.)
4	IN2	Control input pin for channel 2 and built-in pull-down resistor (100 kΩ typ.)
5	IN3	Control input pin for channel 3 and built-in pull-down resistor (100 kΩ typ.)
6	IN4	Control input pin for channel 4 and built-in pull-down resistor (100 kΩ typ.)
7	IN5	Control input pin for channel 5 and built-in pull-down resistor (100 kΩ typ.)
8	IN6	Control input pin for channel 6 and built-in pull-down resistor (100 kΩ typ.)
9	IN7	Control input pin for channel 7 and built-in pull-down resistor (100 kΩ typ.)
10	IN8	Control input pin for channel 8 and built-in pull-down resistor (100 kΩ typ.)
11	GND	GND pin; in common with the pin no.2 internally.
12	V <sub>DD</sub>	Power supply pin; in common with the pin no.1 internally.
13	N.C.	—
14	N.C.	—
15	OUT8	Output pin for channel 8
16	OUT7	Output pin for channel 7
17	OUT6	Output pin for channel 6
18	OUT5	Output pin for channel 5
19	OUT4	Output pin for channel 4
20	OUT3	Output pin for channel 3
21	OUT2	Output pin for channel 2
22	OUT1	Output pin for channel 1
23	N.C.	—
24	N.C.	—

**TIMING CHART**

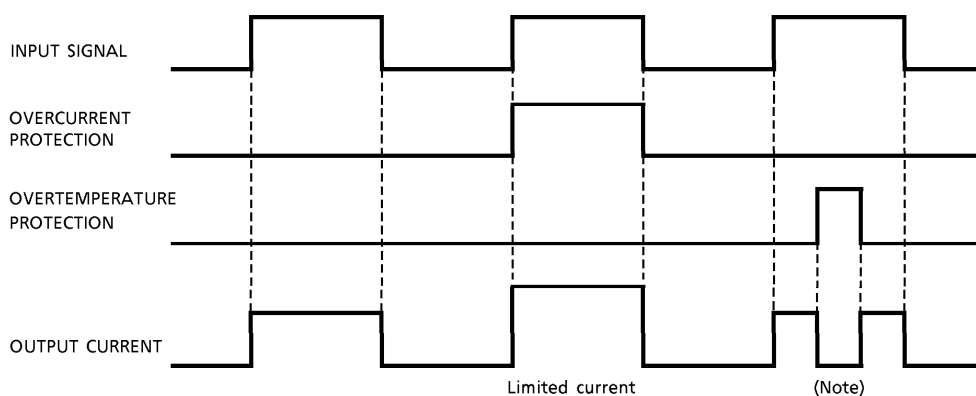

(Note) : The overheating detector circuits feature hysteresis. After overheating is detected, normal operation is restored only when the junction temperature falls by the hysteresis amount (10°C typ.) in relation to the overheating detection temperature.

**TRUTH TABLE**

INPUT SIGNAL	OUTPUT SIGNAL	STATE
L	L	Normal
H	H	
L	L	Overcurrent protection
H	Internally limited	
L	L	Overtemperature protection
H	L	

**MAXIMUM RATINGS (Ta = 25°C)**

CHARACTERISTIC	SYMBOL	RATING	UNIT
Supply Voltage	V <sub>DD</sub>	45	V
Input Voltage	V <sub>IN</sub>	-0.5~7	V
Drain-source Voltage	V <sub>DS</sub>	60	V
Output Current	I <sub>O</sub>	Internally Limited	A
Power Dissipation (Operating All Channels, Ta = 25°C)	P <sub>T</sub>	0.8	W
		1.5 (Note)	
Single Pulse Avalanche Energy	E <sub>AS</sub>	10	mJ
Operating Temperature	T <sub>opr</sub>	-40~85	°C
Junction Temperature	T <sub>j</sub>	150	°C
Storage Temperature	T <sub>stg</sub>	-55~150	°C

**THERMAL CHARACTERISTIC**

CHARACTERISTIC	SYMBOL	RATING	UNIT
Thermal Resistance Junction to Ambient (Operating All Channels, Ta = 25°C)	ΣR <sub>th(j-a)</sub>	156.3	°C/W
		83.4 (Note)	

(Note) : 60 mm × 60 mm × 1.6 t when a device is mounted on a glass epoxy PCB. (DC)

**ELECTRICAL CHARACTERISTICS** (Unless otherwise specified,  $V_{DD} = 8\sim 40\text{ V}$ ,  $T_a = 25^\circ\text{C}$ )

CHARACTERISTIC		SYMBOL	TEST CIRCUIT	TEST CONDITION	MIN	TYP.	MAX	UNIT
Operating Supply Voltage		$V_{DD}$	—	—	8	—	40	V
Supply Current		$I_{DD}$	—	$V_{DD} = 40\text{ V}$ , $V_{IN} = 0\text{ V}$	—	—	5	mA
Input Voltage	"L" level	$V_{IL}$	—	—	—	—	1.5	V
	"H" level	$V_{IH}$	—	—	3.5	—	—	
Input Current		$I_{IL}$	—	$V_{DD} = 24\text{ V}$ , $V_{IN} = 0\text{ V}$	-10	—	10	$\mu\text{A}$
		$I_{IH}$	—	$V_{DD} = 24\text{ V}$ , $V_{IN} = 5\text{ V}$	—	50	200	
Output On Resistance		$R_{DS(ON)}$	—	$V_{DD} = 12\text{ V}$ , $I_O = 0.5\text{ A}$	—	0.9	1.2	$\Omega$
Output Leakage Current		$I_{OL}$	—	$V_{DD} = 40\text{ V}$ , $V_{IN} = 0\text{ V}$	—	—	100	$\mu\text{A}$
Overcurrent Protection		$I_S$	—	—	1	—	3	A
Overtemperature Protection	Temperature	$T_{SD}$	—	—	—	160	—	$^\circ\text{C}$
	Hysteresis	$\Delta T_{SD}$	—	—	—	10	—	
Switching Time		$t_{ON}$	1	$V_{DD} = 12\text{ V}$ , $R_L = 24\ \Omega$	—	11	200	$\mu\text{s}$
		$t_{OFF}$			—	4	50	

**DESCRIPTION OF PROTECTOR CIRCUIT**

(1) Overtemperature Protection

- Four overheating detector circuits are built in. One each for channels 1 and 2 ; channels 3 and 4 ; channels 5 and 6 ; and channels 7 and 8. The circuit logic is that, when any of the four detectors detects overheating, the circuit turns the output of both channels off (for example, channels 1 and 2).
- The overheating detector circuits feature hysteresis. After overheating is detected, normal operation is restored only when the junction temperature falls by the hysteresis amount ( $10^\circ\text{C}$  typ.) in relation to the overheating detection temperature.

(2) Overcurrent Protection

- When overcurrent is detected, the overcurrent limiter function limits the output current. Normal operation is restored when the load current drops below the overcurrent detection value.

**TEST CIRCUIT**

Switching Time

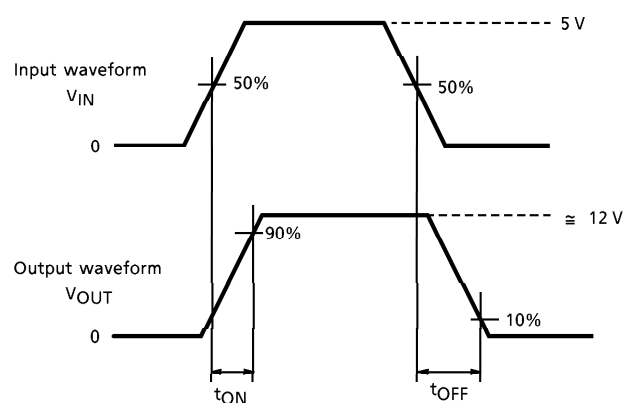
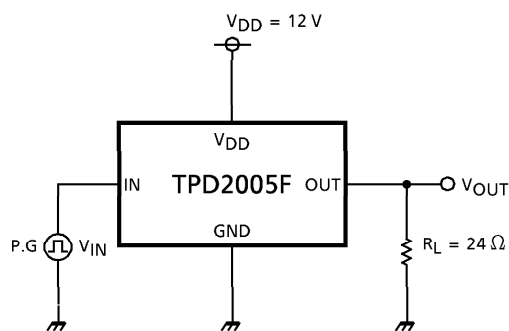

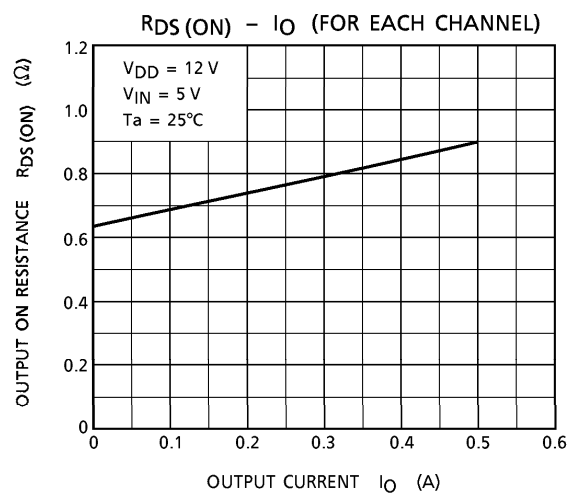
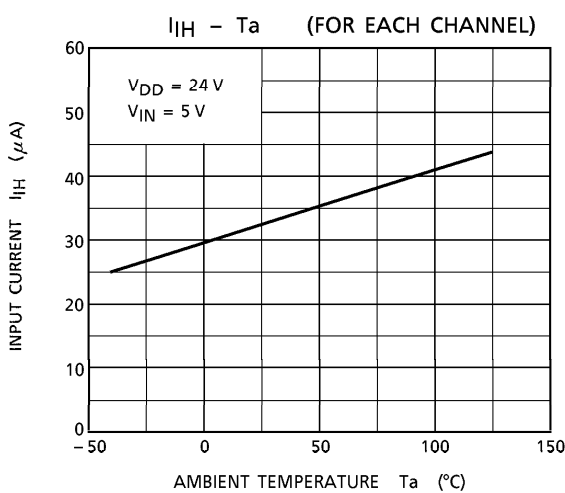
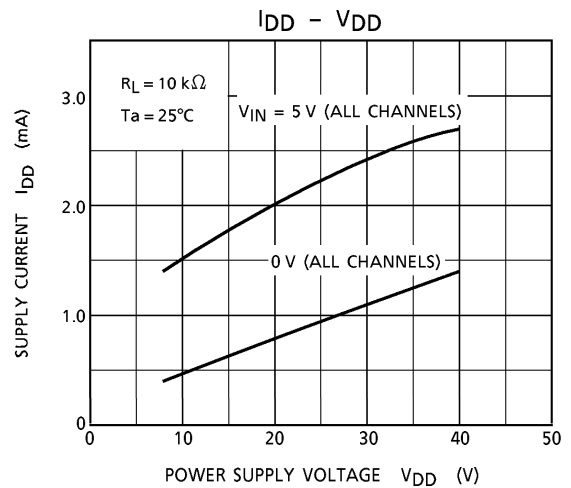
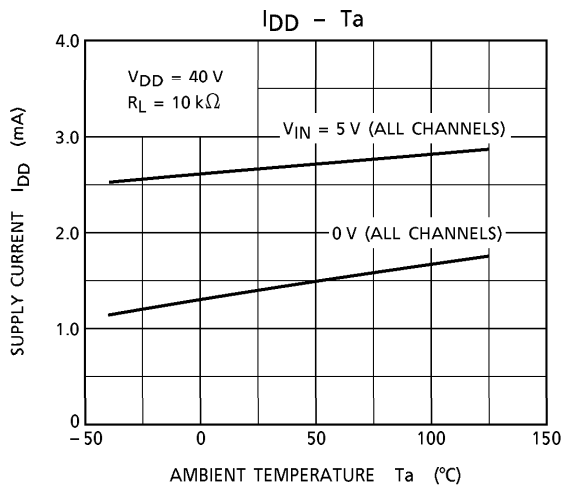
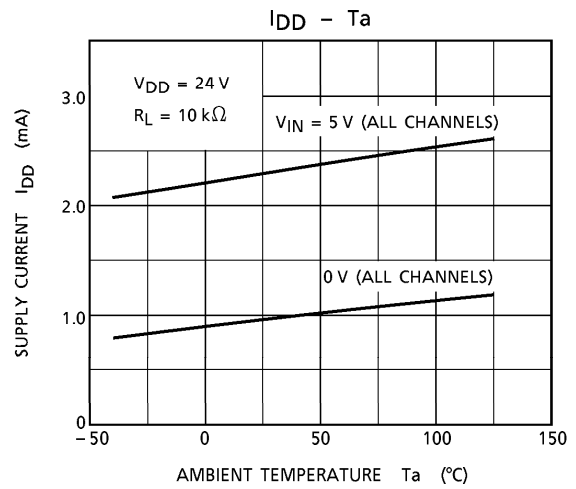
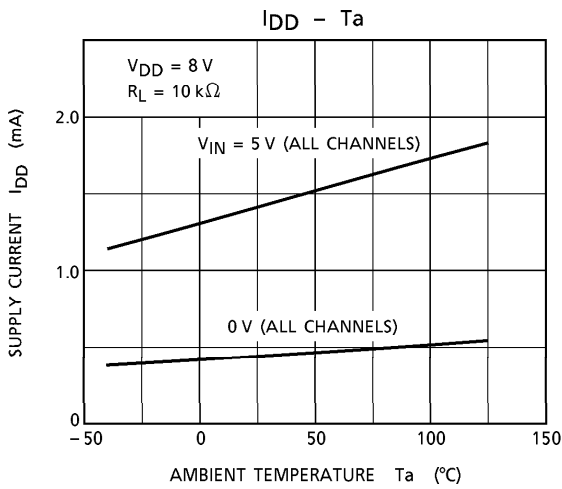

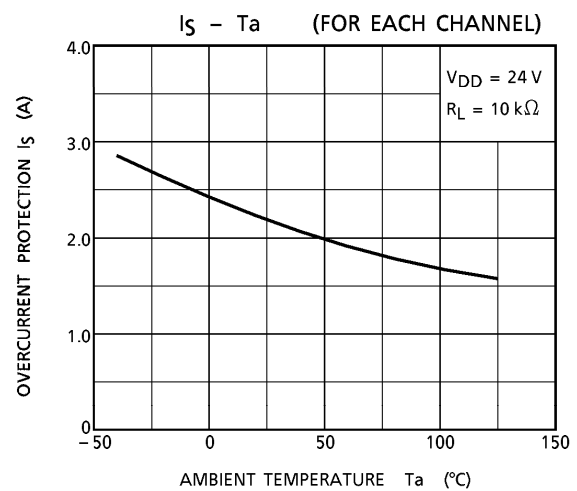
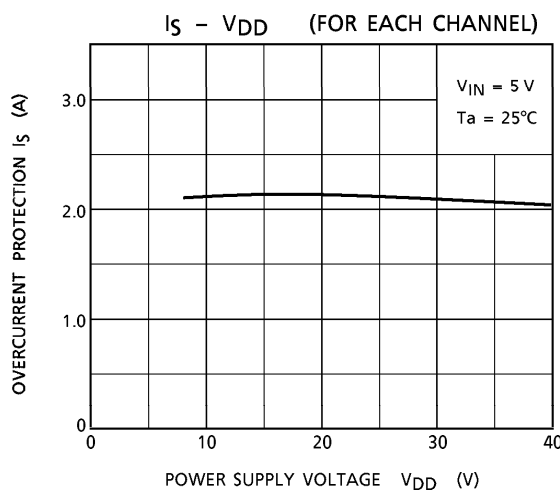
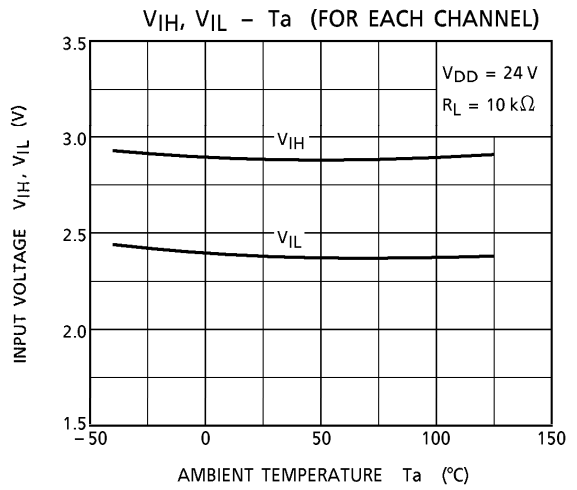
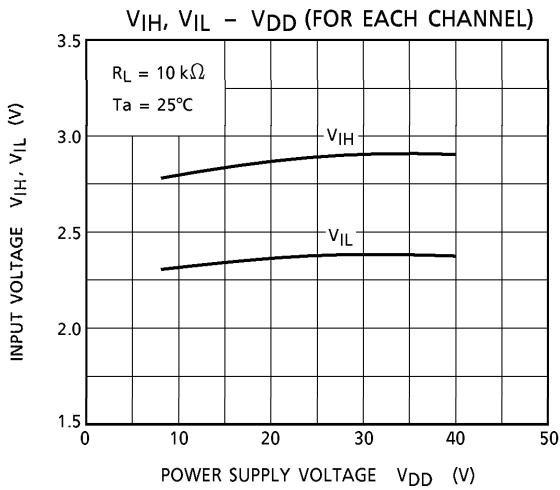
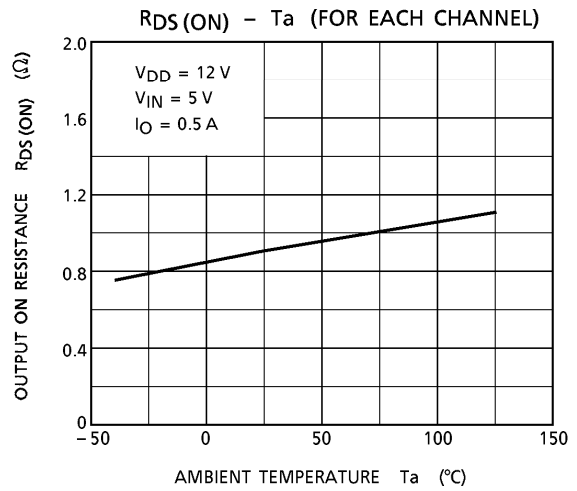
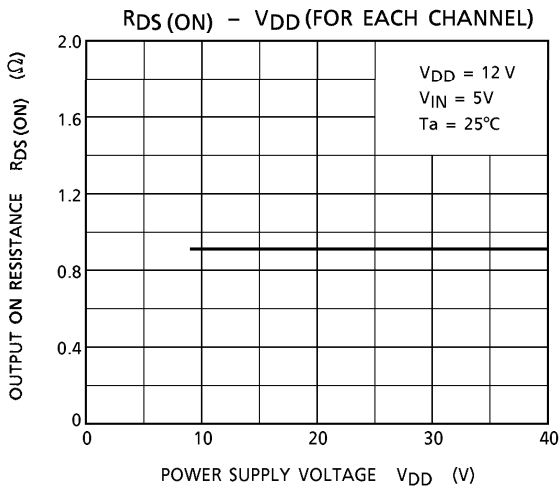

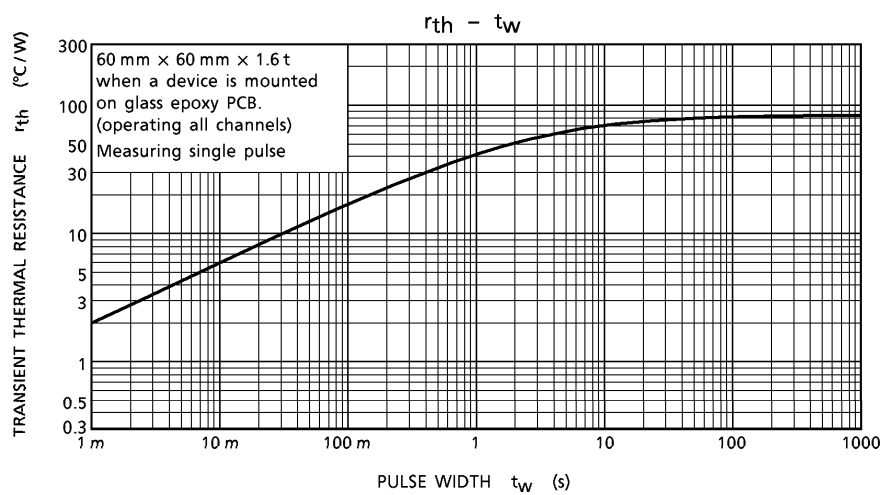
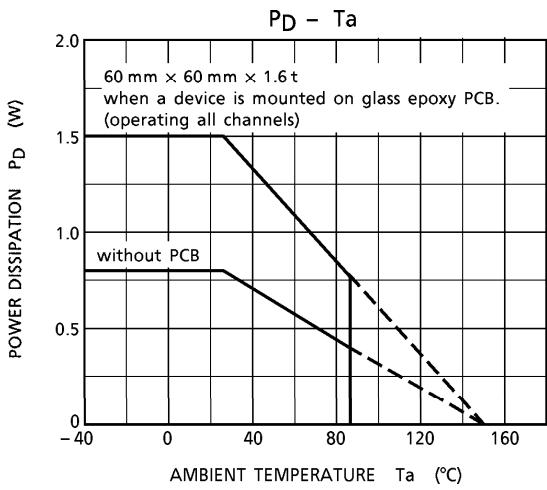
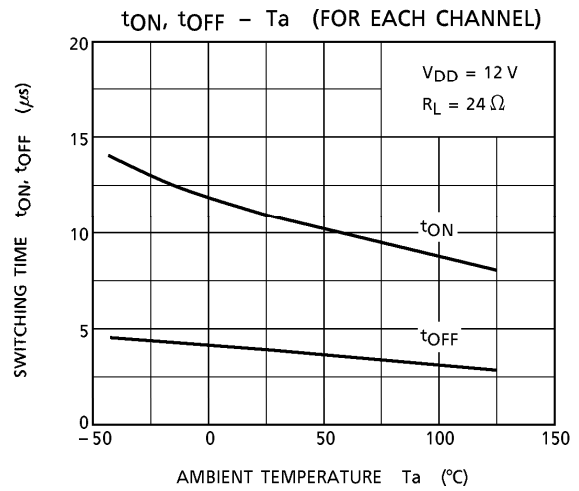
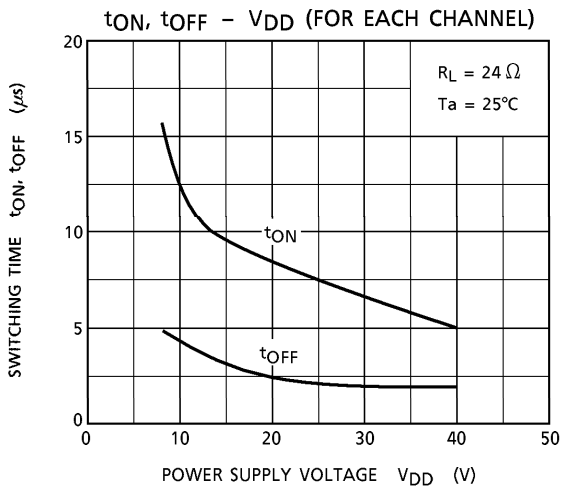



**CAUTION ON USAGE**

1. As protection against reverse connection of batteries is not provided, take protective measures using external circuits.
2. As a negative bias protector circuit is not built into the output pins, if negative bias is applied to the output pins, be sure to connect a freewheel diode between OUT and GND.

**MOISTURE-PROOF PACKING**

After the pack is opened, use the devices in a 30°C, 60% RH environment, and within the 48 hours. Embossed-tape packing cannot be baked. Devices so packed must be within their allowable time limits after unpacking, as specified on the packing.

Tape packing quantity: 500 devices/reel (EL) or 2000 devices/reel (EL1)

PACKAGE DIMENSIONS  
SSOP24-P-300-1.00B

Unit : mm

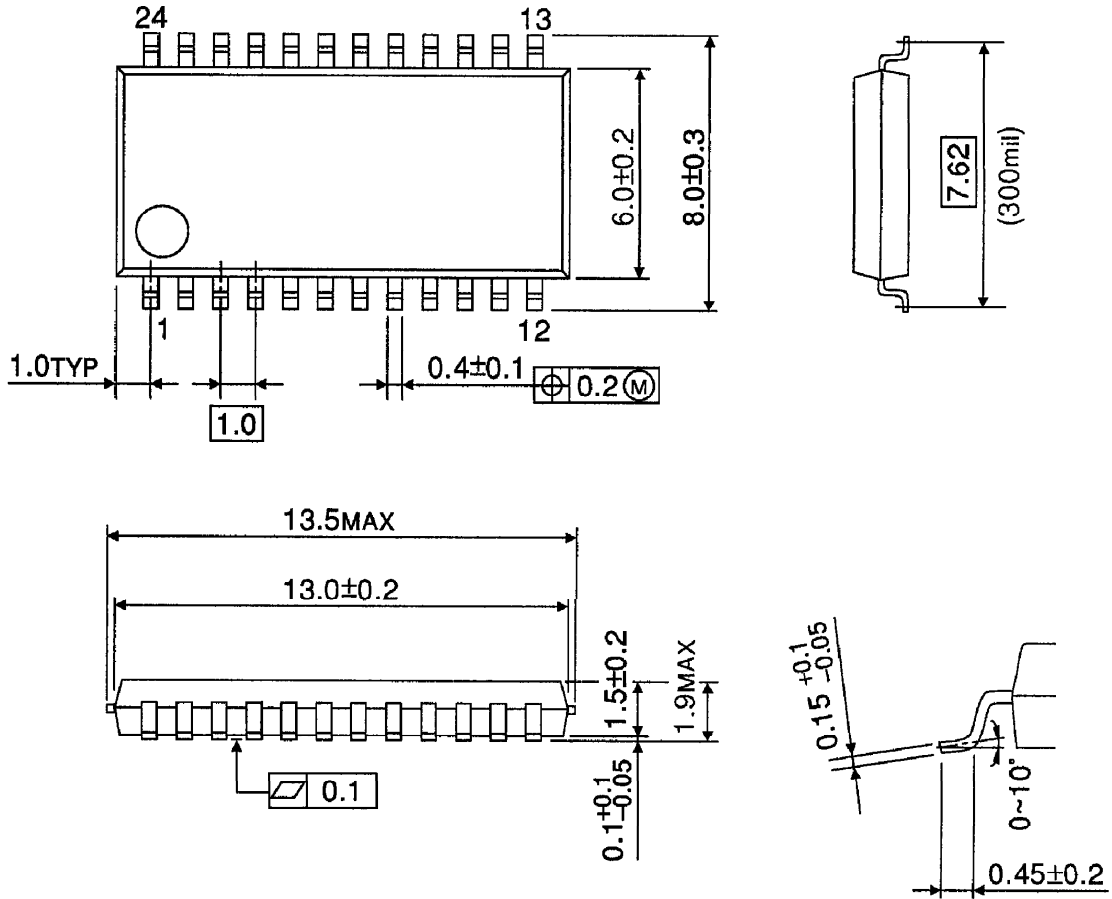

Weight : 0.29 g (typ.)