

Features

- Avalanche rugged technology.
- Low input capacitance.
- Improved gate charge.
- Low leakage current : 10uA (Max.) @ $V_{DS}=500V$.
- Low $R_{DS(ON)}$: 1.17 Ω (Typ.)

Ordering Information

Type NO.	Marking	Package Code
STK830FC	STK830	TO-220F-3SL

Outline Dimensions

unit : mm

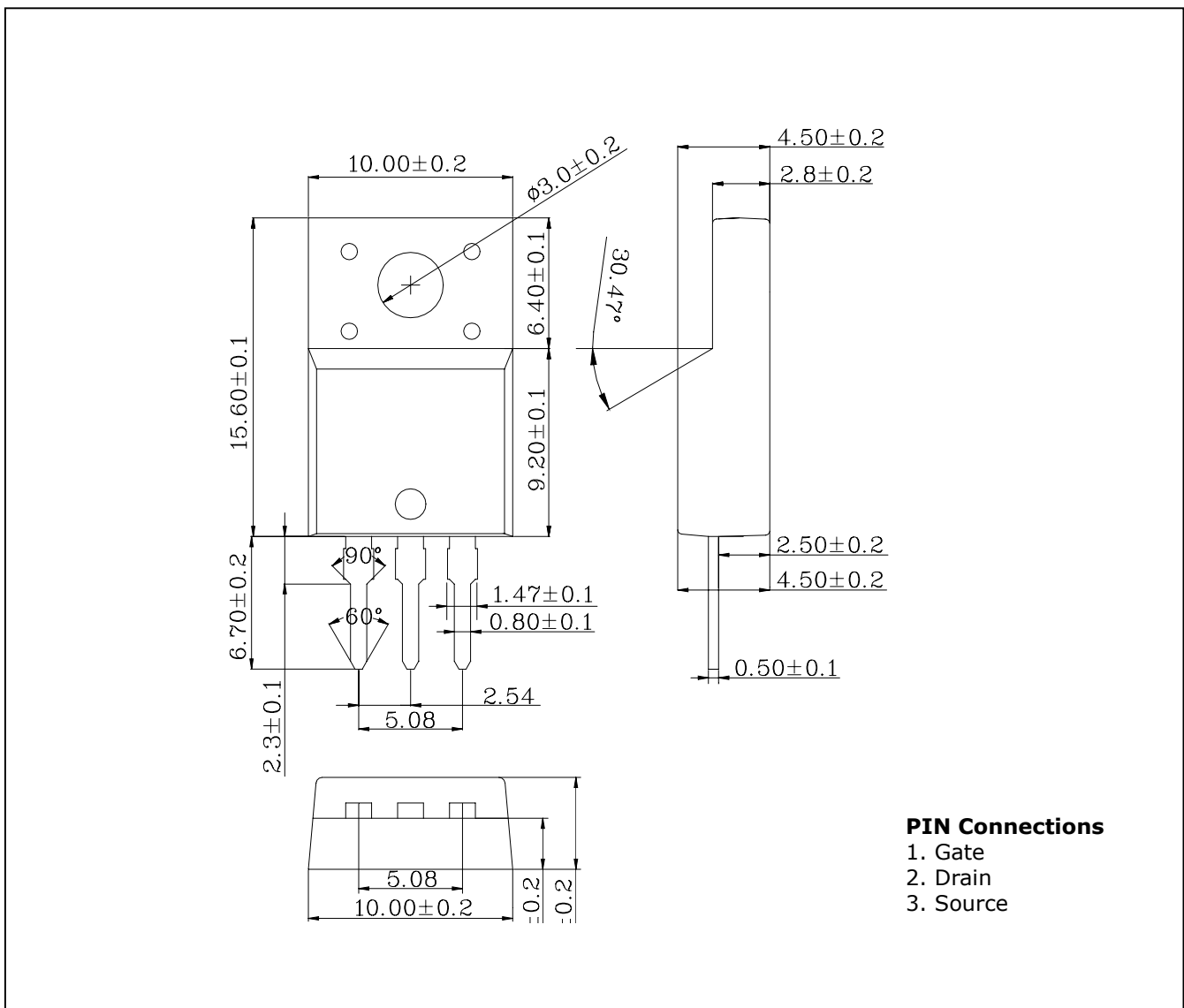

PIN Connections

1. Gate
2. Drain
3. Source

Absolute maximum ratings

Characteristic	Symbol	Rating	Unit
Drain-Source voltage	V_{DSS}	500	V
Gate-Source voltage	V_{GS}	± 30	V
Continuous Drain current ($T_c=25^\circ\text{C}$)	I_D	4.5*	A
Continuous Drain current ($T_c=100^\circ\text{C}$)	I_D	2.9*	A
Drain Current-Pulsed ①	I_{DM}	18	A
Power Dissipation ($T_c=25^\circ\text{C}$)	P_D	38	W
Linear Derating Factor		0.3	W/ $^\circ\text{C}$
Single Pulsed Avalanche Energy ②	E_{AS}	270	mJ
Avalanche current ①	I_{AR}	4.5	A
Repetitive Avalanche Energy ①	E_{AR}	7.3	mJ
Peak Diode Recovery dv/dt	dv/dt	5.5	V/ns
Operating Junction and Storage temperature range	T_J, T_{stg}	-55~150	$^\circ\text{C}$
Maximum lead temp. for soldering Purpose, 1/8" from case for 5-seconds	T_L	300	$^\circ\text{C}$

* Limited by Maximum junction Temperature

Thermal Resistance

Characteristic	Symbol	Typ.	Max	Units
Junction-to-Case	$R_{\theta JC}$		3.31	$^\circ\text{C}/\text{W}$
Case-to-Sink	$R_{\theta CS}$	0.5		
Junction-to-Ambient	$R_{\theta JA}$		62.5	

Electrical Characteristics (Tc=25°C unless otherwise specified)

Characteristic	Symbol	Test Condition	Min.	Typ.	Max.	Unit
Drain-Source breakdown voltage	BV_{DSS}	$I_D=250\mu A, V_{GS}=0$	500			V
Gate-Threshold voltage	$V_{GS(th)}$	$I_D=250\mu A, V_{DS}=5V$	2.0		4.0	V
Drain-source leakage current	I_{DSS}	$V_{DS}=500V$			10	μA
Gate-source leakage	I_{GSS}	$V_{DS}=0V, V_{GS}=\pm 30V$			± 100	nA
Drain-Source on-resistance ④	$R_{DS(on)}$	$V_{GS}=10V, I_D=2.25A$			1.5	Ω
Forward transconductance ④	g_{fs}	$V_{DS}=50V, I_D=2.25A$		3.87		S
Input capacitance	C_{iss}	$V_{GS}=0V, V_{DS}=25V, f=1MHz$		760	900	pF
Output capacitance	C_{oss}			85	100	
Reverse transfer capacitance	C_{rss}			15	22	
Turn-on delay time	$t_{d(on)}$	$V_{DD}=250V, I_D=4.5A$ $R_G=12\Omega$ ④⑤		15	40	ns
Rise time	t_r			16	40	
Turn-off delay time	$t_{d(off)}$			66	140	
Fall time	t_f			22	55	
Total gate charge	Q_g	$V_{DS}=400V, V_{GS}=10V,$ $I_D=4.5A$ ④⑤		33	43	nC
Gate-source charge	Q_{gs}			4.4		
Gate-drain("Miller")charge	Q_{gd}			16.6		

Source-Drain Diode Ratings and Characteristics

Characteristic	Symbol	Test Condition	Min	Typ	Max	Units
Continuous source current	I_S	Integral reverse pn-diode in the MOSFET			4.5	A
Pulsed-source current ①	I_{SM}				18	
Diode forward voltage ④	V_{SD}	$T_J=25^\circ C, V_{GS}=0V, I_S=4.5A$			1.4	V
Reverse recovery time	t_{rr}	$T_J=25^\circ C, I_F=4.5A$ $di_F/dt=100A/us$ ④		285		ns
Reverse recovery charge	Q_{rr}			2.0		μC

Note ;

- ① Repetitive Rating : Pulse Width Limited by Maximum Junction Temperature
- ② $L=30mH, I_{AS}=4.5A, V_{DD}=50V, R_G=27\Omega$, starting $T_J=25^\circ C$
- ③ $I_{SD} \leq 4.5A, di/dt \leq 130A/us, V_{DD} \leq BV_{DSS}$, starting $T_J=25^\circ C$
- ④ Pulse Test : Pulse Width=250us, Duty cycle $\leq 2\%$
- ⑤ Essentially independent of operating temperature

Electrical Characteristic Curves

Fig. 1 $I_D - V_{DS}$

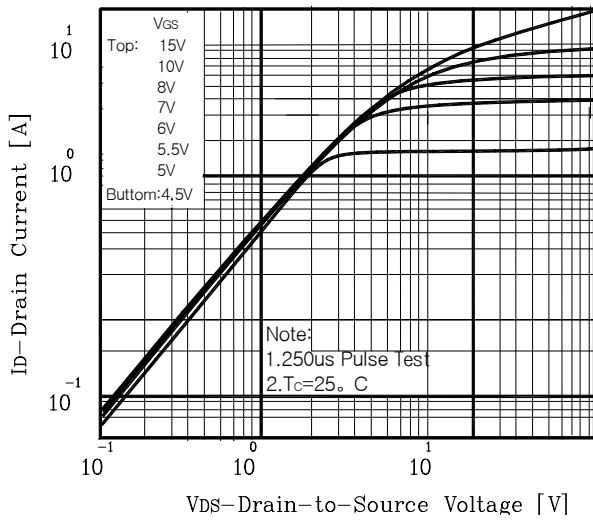

Fig. 2 $I_D - V_{GS}$

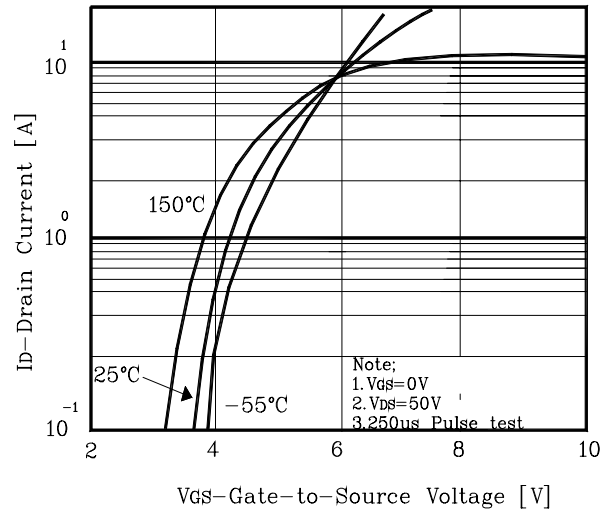

Fig. 3 $R_{DS(on)} - I_D$

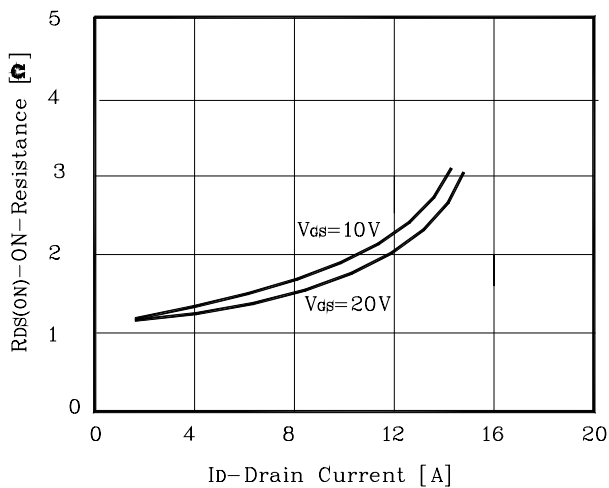

Fig. 4 $I_{DR} - V_{SD}$

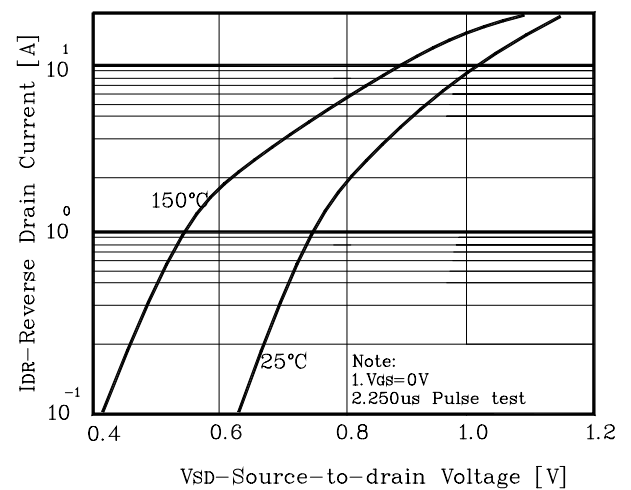

Fig. 5 Capacitance - V_{DS}

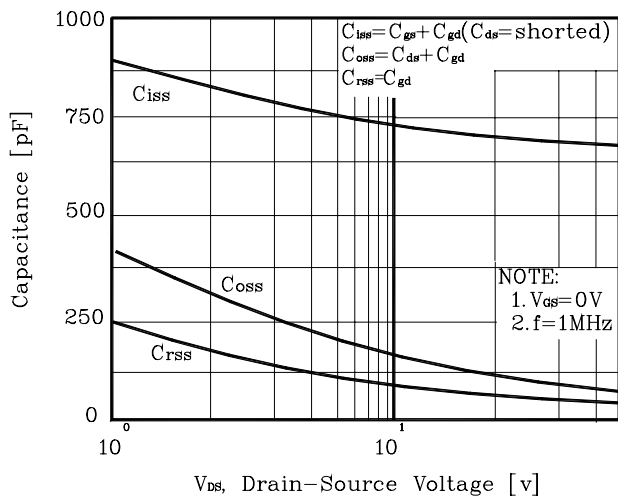

Fig. 6 $V_{GS} - Q_G$

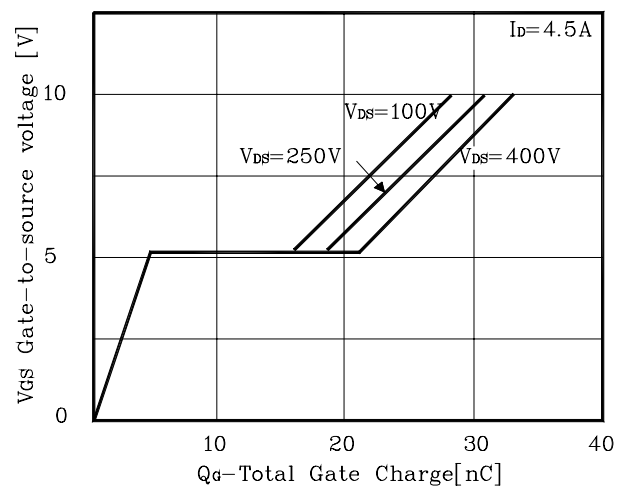

Fig. 7 $BV_{DSS} - T_J$

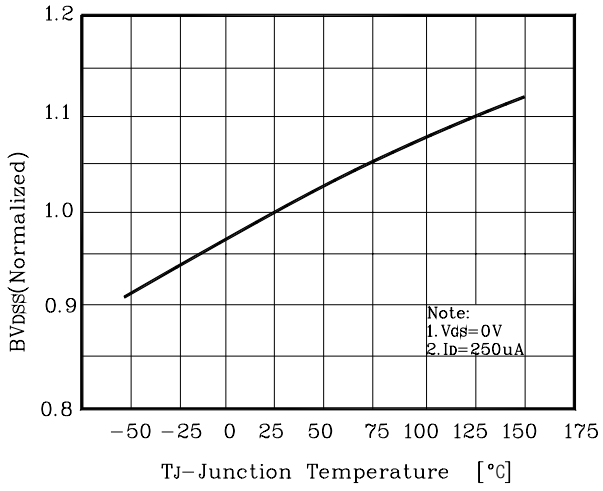

Fig. 8 $R_{DS(on)} - T_J$

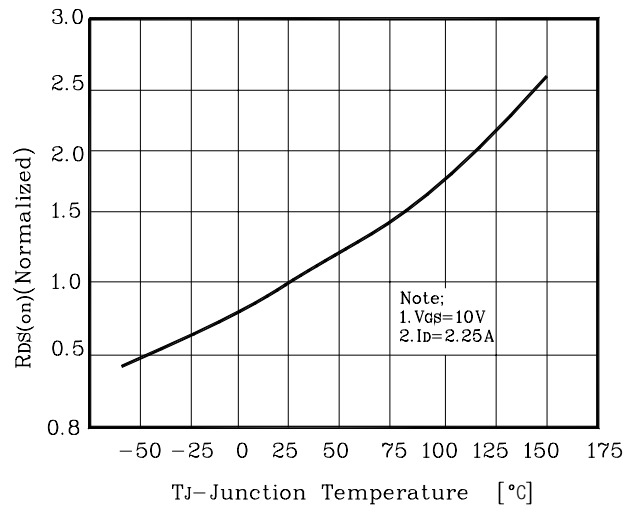

Fig. 9 $I_D - T_C$

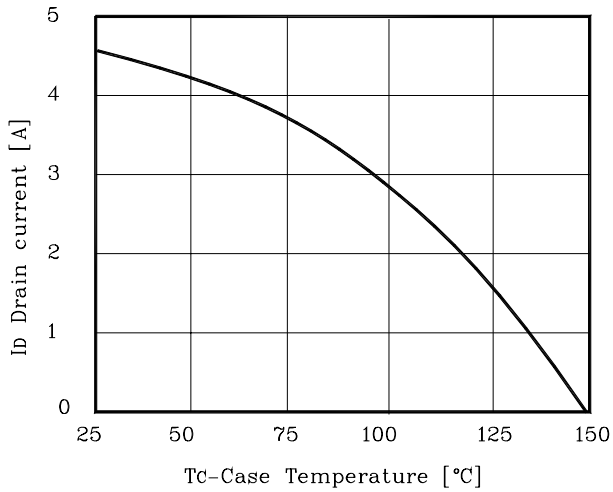

Fig. 10 Safe operating Area

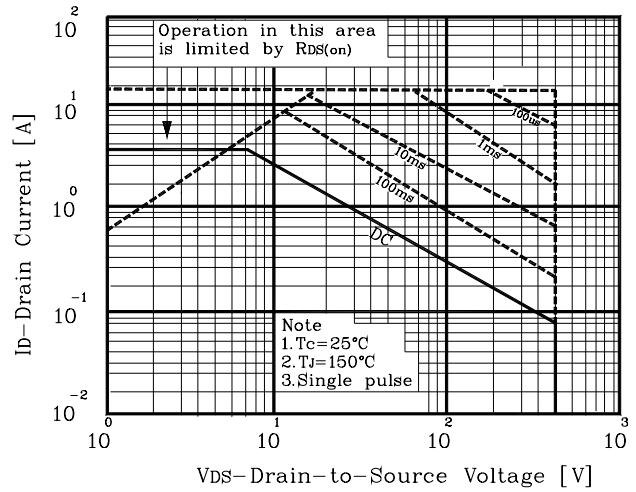

Fig. 11 Thermal Response

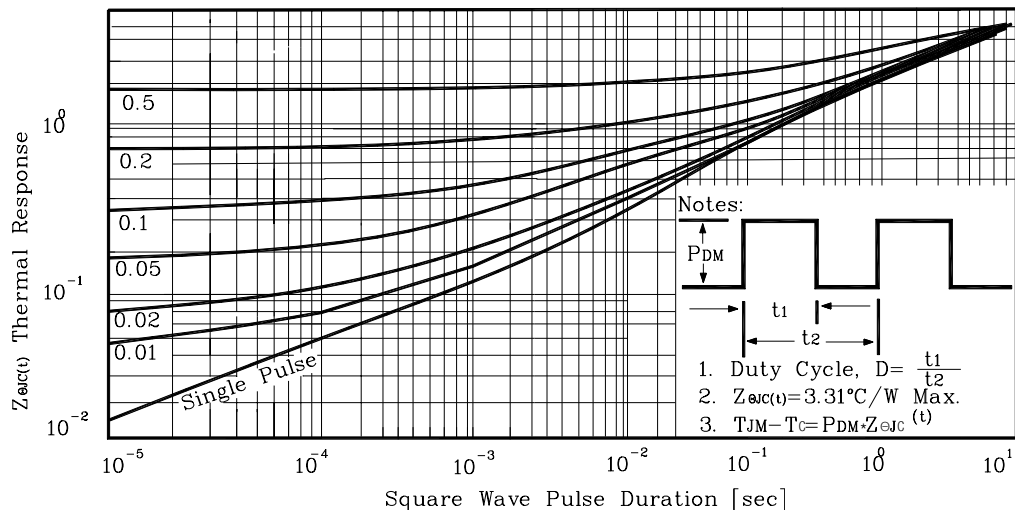

Fig. 12 Gate Charge Test Circuit & Waveform

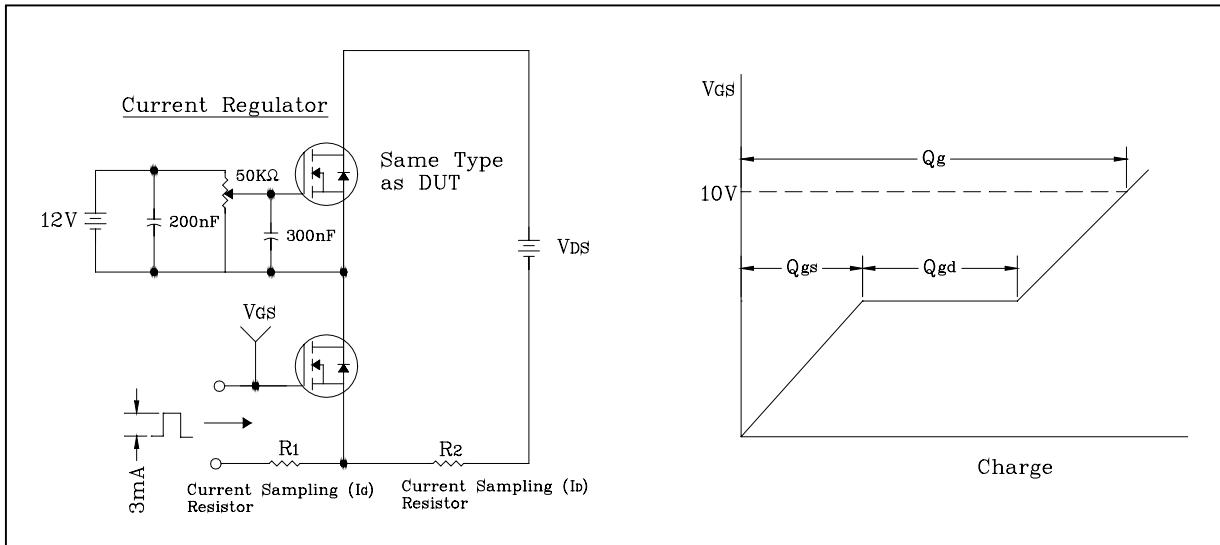

Fig. 13 Resistive Switching Test Circuit & Waveform

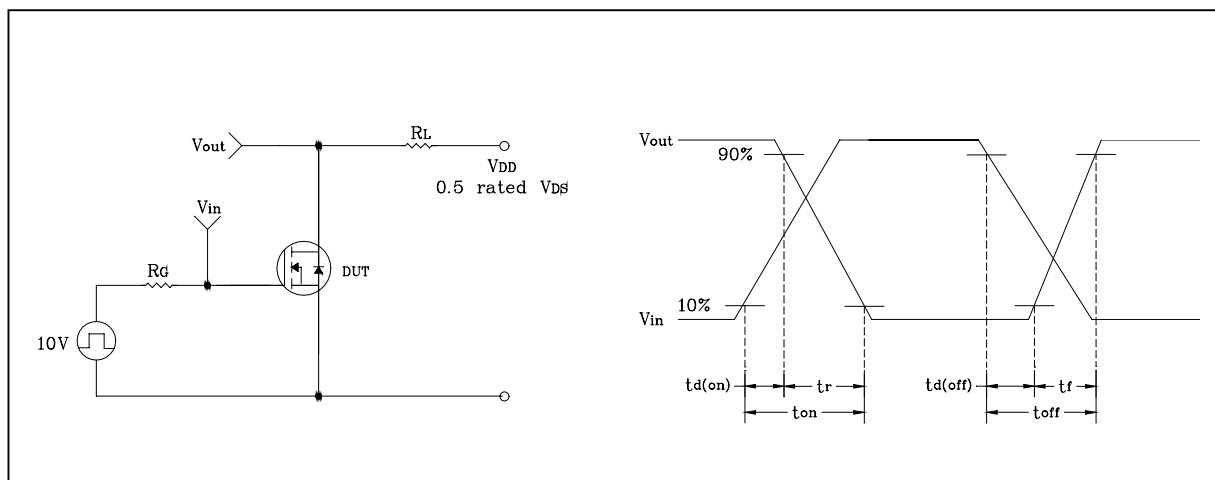

Fig. 14 Unclamped Inductive Switching Test Circuit & Waveform

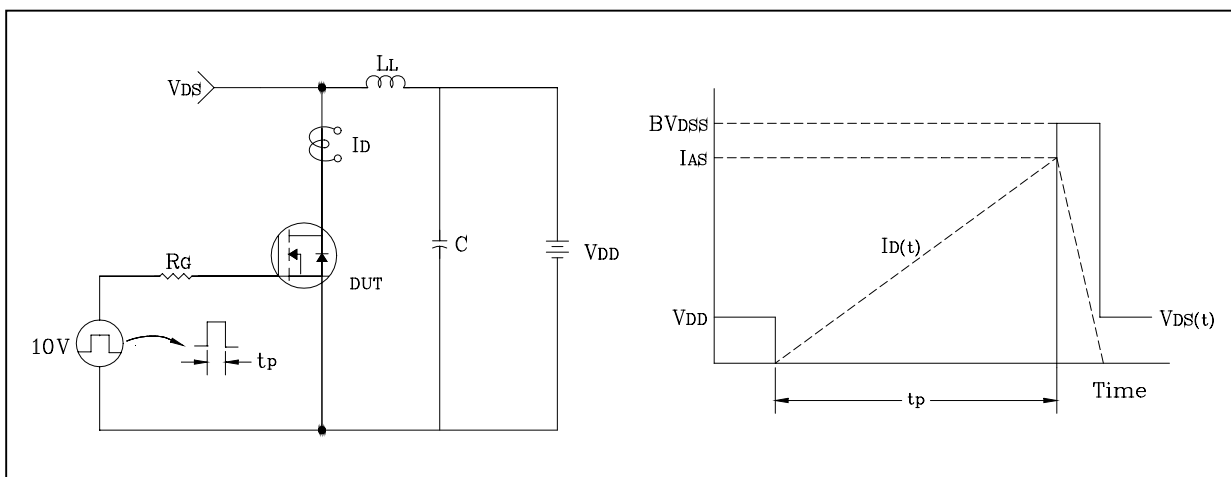
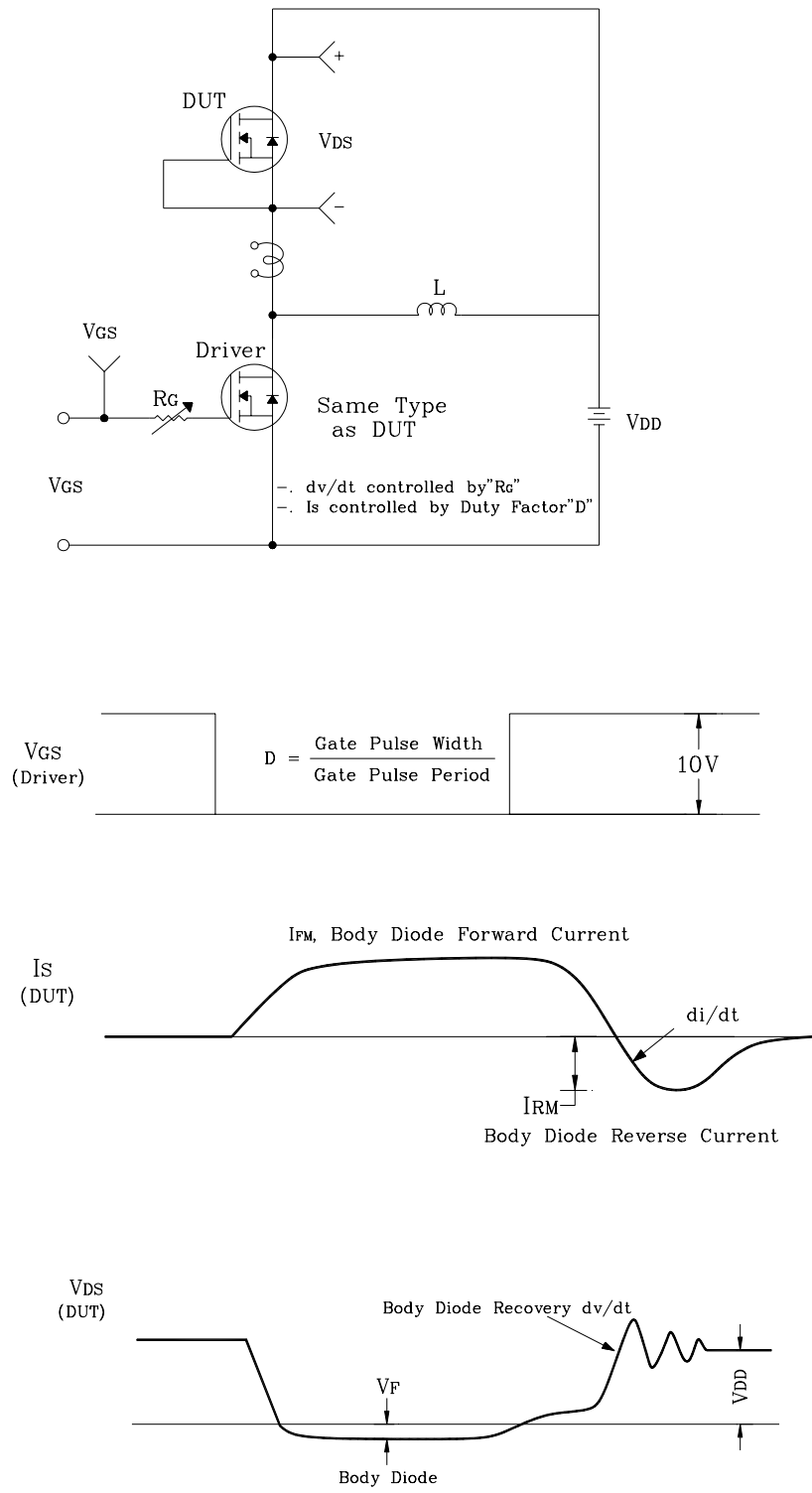

Fig. 15 Peak Diode Recovery dv/dt Test Circuit & Waveform



These AUK products are intended for usage in general electronic equipments(Office and communication equipment, measuring equipment, domestic electrification, etc.).

Please make sure that you consult with us before you use these AUK products in equipments which require high quality and/or reliability, and in equipments which could have major impact to the welfare of human life(atomic energy control, airplane, spaceship, traffic signal, combustion central, all types of safety device, etc.).

AUK cannot accept liability to any damage which may occur in case these AUK products were used in the mentioned equipments without prior consultation with AUK.