

SLOTTED SWITCH

T-41-73

MTSS12000 INFRARED LED+ PHOTO IC

APPLICATIONS

- TIMING DETECTION FOR PRINTERS, TYPEWRITERS AND FACSIMILE

FEATURES

- Optical switch edge sensor.
- Wide detection width: 5mm.
- High accuracy detection. Slit width: 0.5 mm.
- Output stays at high level when there is no interruption.
- High speed response.

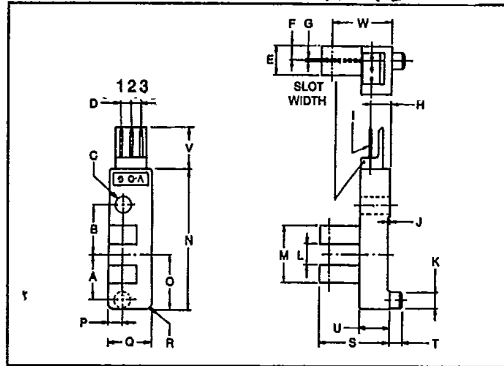

MAXIMUM RATINGS (Ta = 25°C)

CHARACTERISTIC	SYMBOL	RATING	UNIT
Supply Voltage	VCC	5	V
Output Voltage	VOUT	VCC+0.5	V
Low Level Output Current	IOL	50	mA
Operating Temperature Range	Topr	-25 ~ 75	°C
Storage Temperature Range	Tstg	-40 ~ 85	°C

SYMBOL	INCHES	MM
A	0.433 ± 0.004	11.0 ± 0.1
B	0.472 ± 0.004	12.0 ± 0.1
C	0.165 ± 0.008	4.2 ± 0.2
D	0.098	2.5
E	0.276 ± 0.008	7.0 ± 0.2
F	0.135 ± 0.006	3.5 ± 0.15
G	0.020 ± 0.004	0.5 ± 0.1
H	0.209 ± 0.039	5.3 ± 1.0
I	0.025	0.64
J	0.020	0.5
K	0.157 ± 0.006	4.0 ± 0.15
L	0.197 ± 0.008	5.0 ± 0.2
M	0.551 ± 0.008	14.0 ± 0.2
N	1.343 ± 0.008	34.1 ± 0.2
O	0.520 ± 0.008	13.2 ± 0.2
P	0.138 ± 0.059	3.5 ± 0.15
Q	0.425 ± 0.008	10.8 ± 0.2
R	R0.059	R1.5
S	0.689 ± 0.008	17.5 ± 0.2
T	0.118 ± 0.006	3.0 ± 0.15
U	0.295 ± 0.008	7.5 ± 0.2
V	0.409 ± 0.008	10.4 ± 0.2
W	0.591 ± 0.012	15.0 ± 0.3

Note 2

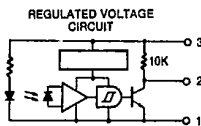
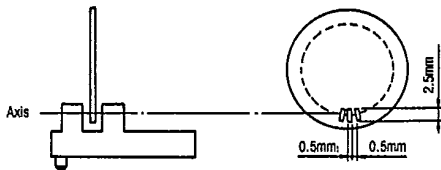

SLOTTED SWITCH

T-41-73

OUTPUT PHOTOLOGIC ($T_a = 25^\circ\text{C}$, $V_{CC} = 5 \pm 0.5\text{V}$)

CHARACTERISTIC	SYMBOL	TEST CONDITION	MIN.	TYP.	MAX.	UNIT
Supply Voltage	V_{CC}	—	4.5	5	6	V
Low Level Supply Current	I_{CCL}	—	—	—	35	mA
High Level Supply Current	I_{CCH}	—	—	—	35	mA
Low Level Output Voltage	V_{OL}	$I_{OL} = 16\text{mA}$	—	—	0.4	V
High Level Output Voltage	V_{OH}	—	(Note 1)	—	—	V
Response Frequency	f	$V_{out} = V_{CC} \times 0.8$ (Note 2)	2000	—	—	Hz

Note 1: $V_{CC} \times 0.8$.

OPTO-ELECTRICAL CHARACTERISTICS ($T_a = 25^\circ\text{C}$)

CHARACTERISTIC	SYMBOL	MIN.	TYP.	MAX.	UNIT
Supply Voltage	V_{CC}	4.5	5	5.5	V
Low Level Output Current	I_{OL} (Note 3)	—	—	16	mA
Response Frequency	f	—	—	2000	Hz
Operating Temperature	T_{opr}	-10	25	60	$^\circ\text{C}$

Note 3: V_{OL} at 0.4V.

- Output is unstable for 100 μsec after power on.
- Surge Voltage Between Pins 150V (Max.).
- Setting torque 6kg/cm (Max.).

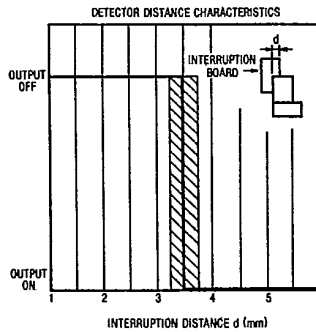
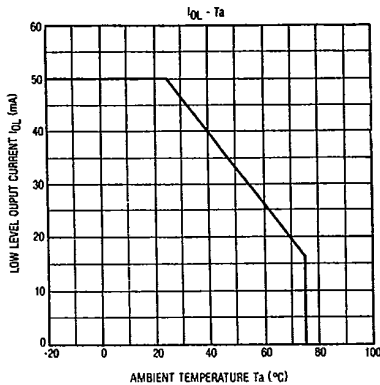

SLOTTED SWITCH

T-41-73

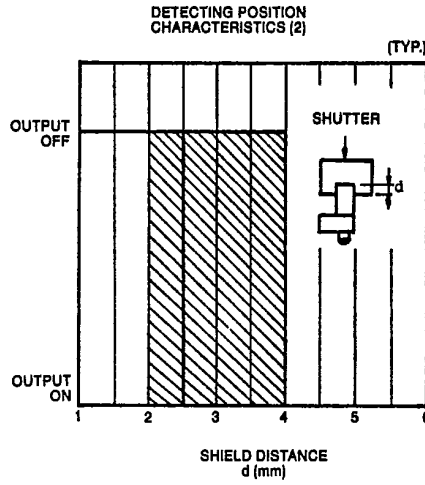
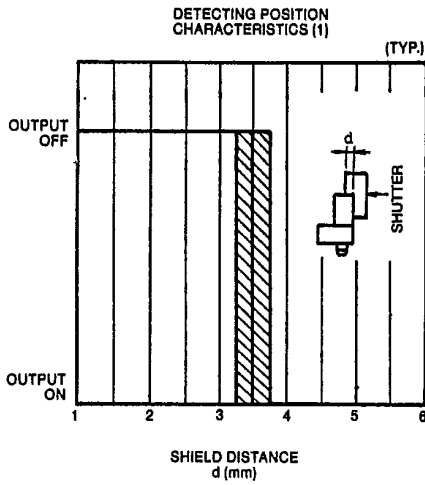

EXAMPLES FOR OPTICAL SHUTTER DESIGN
When designing the optical shutter of rotator, please refer to the following.

Unit in mm

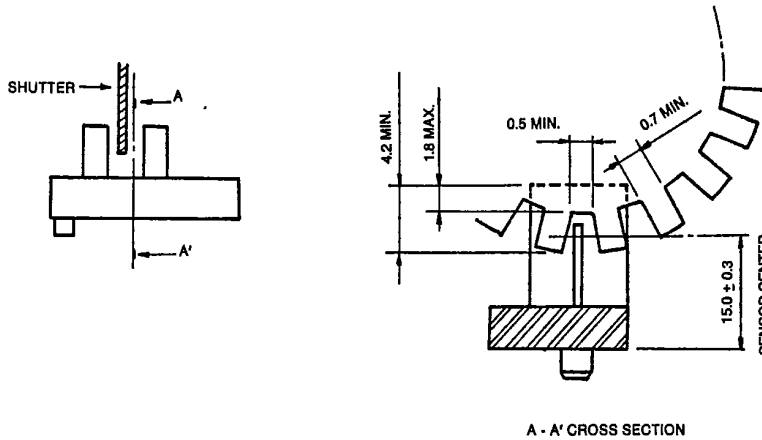

SLOTTED SWITCH

7-41-73

