

## 2.5A, 500V, 3.000 Ohm, N-Channel Power MOSFETs

These are N-Channel enhancement mode silicon gate power field effect transistors. They are advanced power MOSFETs designed, tested, and guaranteed to withstand a specified level of energy in the breakdown avalanche mode of operation. All of these power MOSFETs are designed for applications such as switching regulators, switching convertors, motor drivers, relay drivers, and drivers for high power bipolar switching transistors requiring high speed and low gate drive power. These types can be operated directly from integrated circuits.

Formerly developmental type TA17405.

### Ordering Information

PART NUMBER	PACKAGE	BRAND
IRFR420	TO-252AA	IRFR420
IRFU420	TO-251AA	IRFU420

NOTE: When ordering, use the entire part number. Add the suffix 9A to obtain the TO-252AA variant in the tape and reel, i.e., IRFR4209A.

### Features

- 2.5A, 500V
- $r_{DS(ON)} = 3.000\Omega$
- Single Pulse Avalanche Energy Rated
- SOA is Power Dissipation Limited
- Nanosecond Switching Speeds
- Linear Transfer Characteristics
- High Input Impedance
- Related Literature
  - TB334 "Guidelines for Soldering Surface Mount Components to PC Boards"

### Symbol

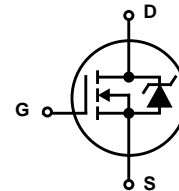

### Packaging

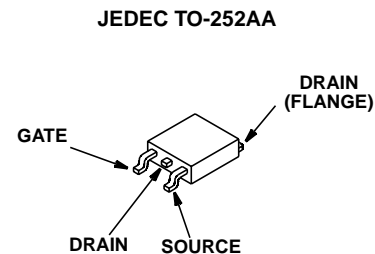
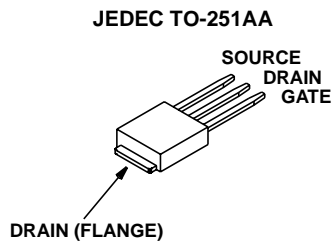

# IRFR420, IRFU420

## Absolute Maximum Ratings $T_C = 25^\circ\text{C}$ , Unless Otherwise Specified

	IRFR420, IRFU420	UNITS
Drain to Source Voltage (Note 1) . . . . .	500	V
Drain to Gate Voltage ( $R_{GS} = 20k\Omega$ ) (Note 1) . . . . .	500	V
Continuous Drain Current . . . . .	2.5	A
$T_C = 100^\circ\text{C}$ . . . . .	1.6	A
Pulsed Drain Current (Note 3) . . . . .	8	A
Gate to Source Voltage . . . . .	$\pm 20$	V
Maximum Power Dissipation . . . . .	50	W
Linear Derating Factor . . . . .	0.4	W/ $^\circ\text{C}$
Single Pulse Avalanche Energy Rating (Note 4) . . . . .	210	mJ
Operating and Storage Temperature . . . . .	-55 to 150	$^\circ\text{C}$
Maximum Temperature for Soldering		
Leads at 0.063in (1.6mm) from Case for 10s. . . . .	300	$^\circ\text{C}$
Package Body for 10s, See Techbrief 334 . . . . .	260	$^\circ\text{C}$

*CAUTION: Stresses above those listed in "Absolute Maximum Ratings" may cause permanent damage to the device. This is a stress only rating and operation of the device at these or any other conditions above those indicated in the operational sections of this specification is not implied.*

### NOTE:

- $T_J = 25^\circ\text{C}$  to  $125^\circ\text{C}$ .

## Electrical Specifications $T_C = 25^\circ\text{C}$ , Unless Otherwise Specified

PARAMETER	SYMBOL	TEST CONDITIONS	MIN	TYP	MAX	UNITS
Drain to Source Breakdown Voltage	$BV_{DSS}$	$I_D = 250\mu\text{A}$ , $V_{GS} = 0\text{V}$ (Figure 10)	500	-	-	V
Gate Threshold Voltage	$V_{GS(TH)}$	$V_{GS} = V_{DS}$ , $I_D = 250\mu\text{A}$	2.0	-	4.0	V
Zero Gate Voltage Drain Current	$I_{DSS}$	$V_{DS} = \text{Rated } BV_{DSS}$ , $V_{GS} = 0\text{V}$	-	-	25	$\mu\text{A}$
		$V_{DS} = 0.8 \times \text{Rated } BV_{DSS}$ , $V_{GS} = 0\text{V}$ , $T_J = 125^\circ\text{C}$	-	-	250	$\mu\text{A}$
On-State Drain Current (Note 2)	$I_{D(ON)}$	$V_{DS} > I_{D(ON)} \times r_{DS(ON)MAX}$ , $V_{GS} = 10\text{V}$	2.5	-	-	A
Gate to Source Leakage Current	$I_{GSS}$	$V_{GS} = \pm 20\text{V}$	-	-	$\pm 100$	nA
Drain to Source On Resistance (Note 2)	$r_{DS(ON)}$	$I_D = 1.3\text{A}$ , $V_{GS} = 10\text{V}$ (Figures 8, 9)	-	2.9	3.0	$\Omega$
Forward Transconductance (Note 2)	$g_{fs}$	$V_{DS} \geq 10\text{V}$ , $I_D = 2.0\text{A}$ (Figure 12)	1.5	2.2	-	S
Turn-On Delay Time	$t_{d(ON)}$	$V_{DD} = 250\text{V}$ , $I_D = 2.5\text{A}$ , $R_{GS} = 18\Omega$ , $R_L = 100\Omega$ , $V_{GS} = 10\text{V}$ MOSFET Switching Times are Essentially Independent of Operating Temperature	-	10	15	ns
Rise Time	$t_r$		-	12	18	ns
Turn-Off Delay Time	$t_{d(OFF)}$		-	28	42	ns
Fall Time	$t_f$		-	12	18	ns
Total Gate Charge (Gate to Source + Gate to Drain)	$Q_{g(TOT)}$		$V_{GS} = 10\text{V}$ , $I_D = 2.5\text{A}$ , $V_{DS} = 0.8 \times \text{Rated } BV_{DSS}$ $I_{G(REF)} = 1.5\text{mA}$ (Figure 14)	-	13	19
Gate to Source Charge	$Q_{gs}$	Gate Charge is Essentially Independent of Operating Temperature	-	2.2	3.3	nC
Gate to Drain "Miller" Charge	$Q_{gd}$		-	6.8	10	nC
Input Capacitance	$C_{ISS}$	$V_{DS} = 25\text{V}$ , $V_{GS} = 0\text{V}$ , $f = 1\text{MHz}$ (Figure 11)	-	350	-	pF
Output Capacitance	$C_{OSS}$		-	54	-	pF
Reverse Transfer Capacitance	$C_{RSS}$		-	9.6	-	pF
Internal Drain Inductance	$L_D$	Measured From the Drain Lead, 6.0mm (0.25in) From Package to Center of Die	-	4.5	-	nH
Internal Source Inductance	$L_S$	Measured From the Source Lead, 6.0mm (0.25in) From Package to Source Bonding Pad	-	7.5	-	nH
Thermal Resistance, Junction to Case	$R_{\theta JC}$		-	-	2.5	$^\circ\text{C/W}$
Thermal Resistance, Junction to Ambient	$R_{\theta JA}$	Mounted on FR-4 Board with Minimum Mounting pad	-	-	110	$^\circ\text{C/W}$

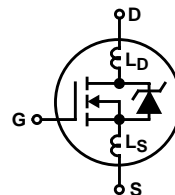

Source to Drain Diode Specifications

PARAMETER	SYMBOL	TEST CONDITIONS	MIN	TYP	MAX	UNITS
Continuous Source to Drain Current	$I_{SD}$	Modified MOSFET Symbol Showing the Integral Reverse P-N Junction Rectifier	-	-	2.5	A
Pulse Source to Drain Current (Note 3)	$I_{SDM}$		-	-	8	A
Source to Drain Diode Voltage (Note 2)	$V_{SD}$	$T_J = 25^\circ\text{C}$ , $I_{SD} = 2.5\text{A}$ , $V_{GS} = 0\text{V}$ (Figure 13)	-	-	1.6	V
Reverse Recovery Time	$t_{rr}$	$T_J = 25^\circ\text{C}$ , $I_{SD} = 2.5\text{A}$ , $dI_{SD}/dt = 100\text{A}/\mu\text{s}$	130	270	540	ns
Reverse Recovery Charge	$Q_{RR}$	$T_J = 25^\circ\text{C}$ , $I_{SD} = 2.5\text{A}$ , $dI_{SD}/dt = 100\text{A}/\mu\text{s}$	0.57	1.2	2.3	$\mu\text{C}$

NOTES:

2. Pulse test: pulse width  $\leq 300\mu\text{s}$ , duty cycle  $\leq 2\%$ .
3. Repetitive rating: pulse width limited by maximum junction temperature. See Transient Thermal Impedance curve (Figure 3).
4.  $V_{DD} = 50\text{V}$ , starting  $T_J = 25^\circ\text{C}$ ,  $L = 60\text{mH}$ ,  $R_G = 25\Omega$ , peak  $I_{AS} = 2.5\text{A}$ .

Typical Performance Curves Unless Otherwise Specified

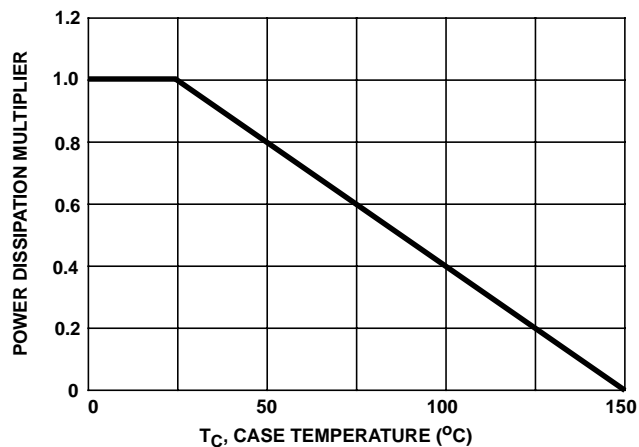

FIGURE 1. NORMALIZED POWER DISSIPATION vs CASE TEMPERATURE

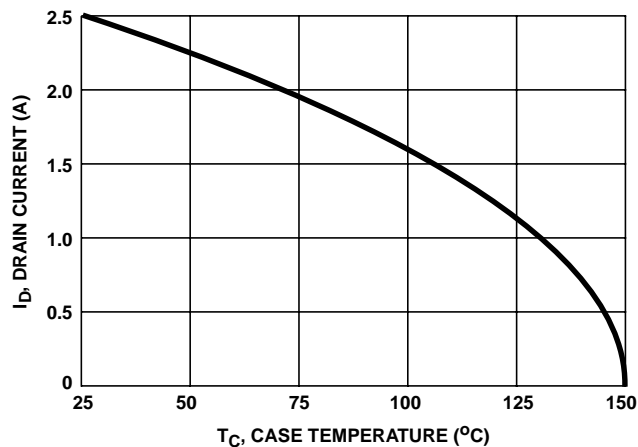

FIGURE 2. MAXIMUM CONTINUOUS DRAIN CURRENT vs CASE TEMPERATURE

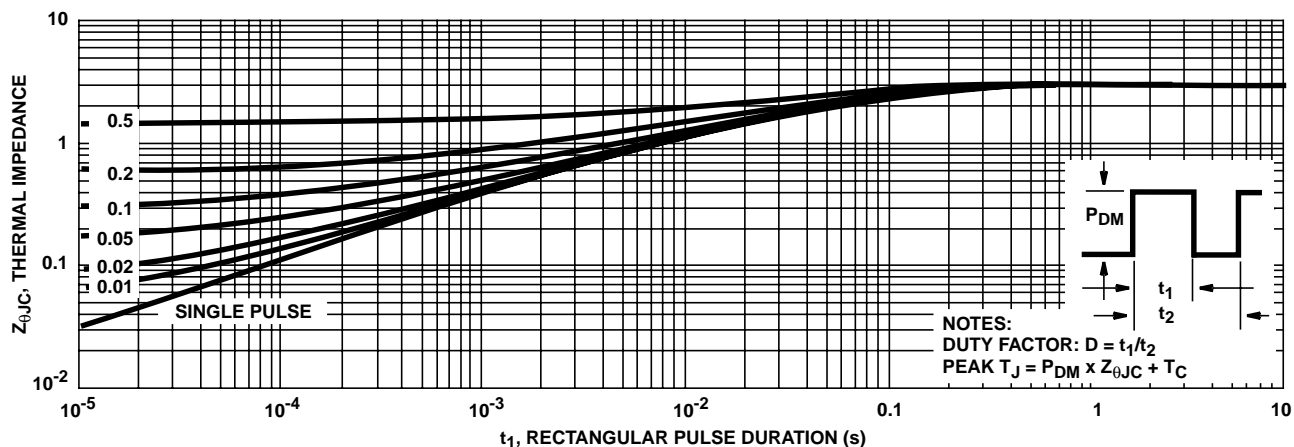

FIGURE 3. MAXIMUM TRANSIENT THERMAL IMPEDANCE

Typical Performance Curves Unless Otherwise Specified (Continued)

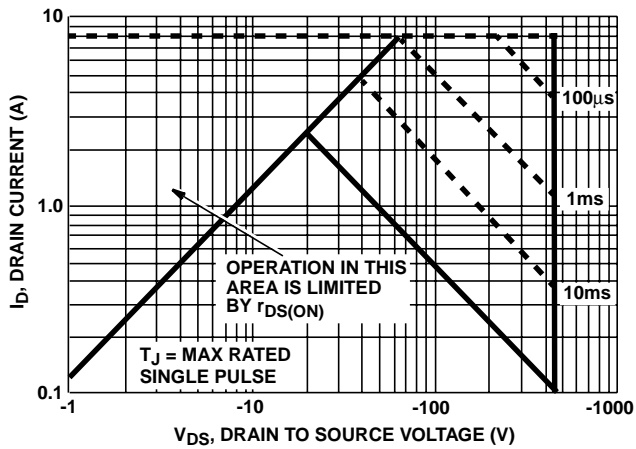

FIGURE 4. FORWARD BIAS SAFE OPERATING AREA

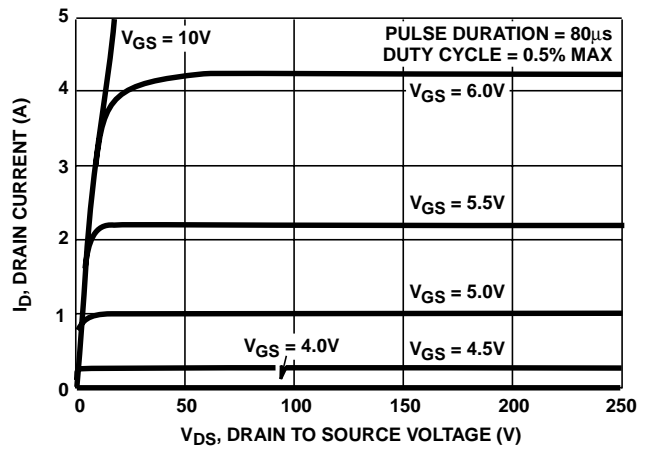

FIGURE 5. OUTPUT CHARACTERISTICS

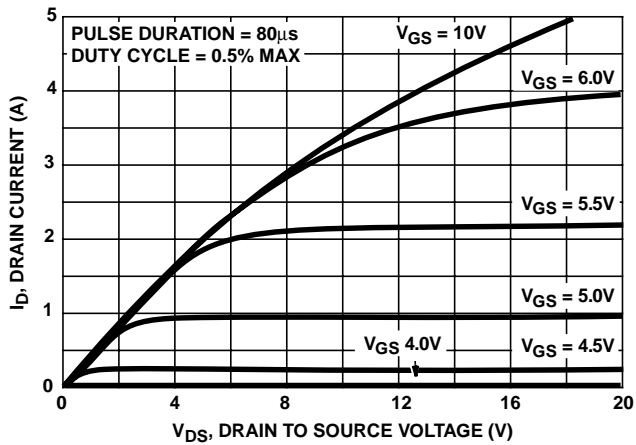

FIGURE 6. SATURATION CHARACTERISTICS

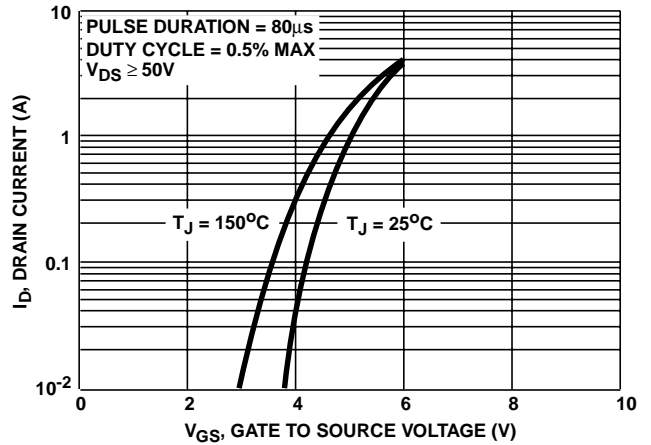

FIGURE 7. TRANSFER CHARACTERISTICS

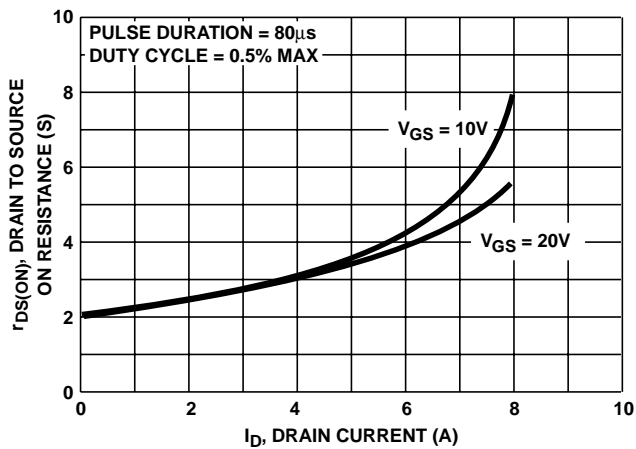

FIGURE 8. DRAIN TO SOURCE ON RESISTANCE vs GATE VOLTAGE AND DRAIN CURRENT

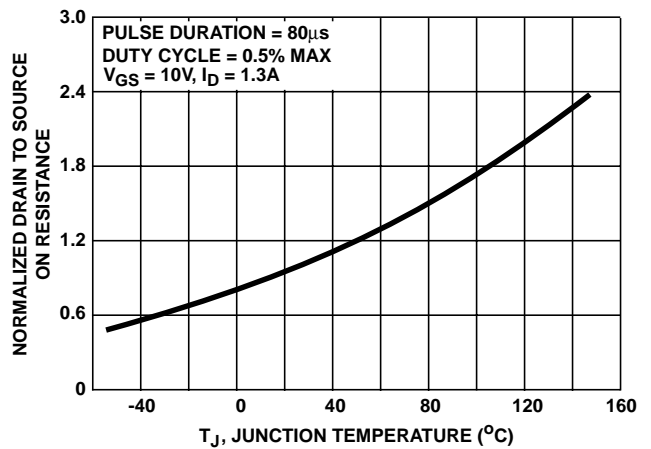

FIGURE 9. NORMALIZED DRAIN TO SOURCE ON RESISTANCE vs JUNCTION TEMPERATURE

Typical Performance Curves Unless Otherwise Specified (Continued)

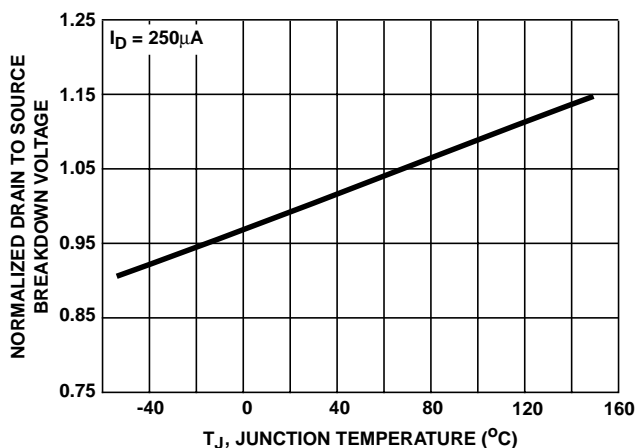

FIGURE 10. NORMALIZED DRAIN TO SOURCE BREAKDOWN VOLTAGE vs JUNCTION TEMPERATURE

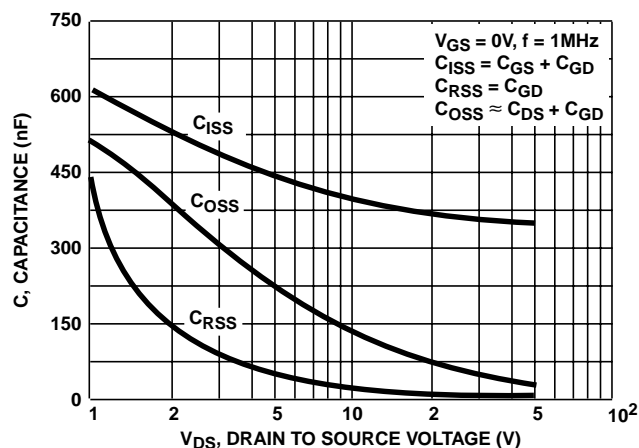

FIGURE 11. CAPACITANCE vs DRAIN TO SOURCE VOLTAGE

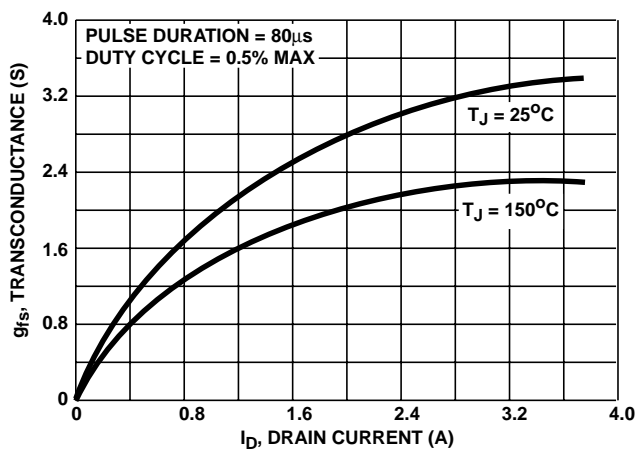

FIGURE 12. TRANSCONDUCTANCE vs DRAIN CURRENT

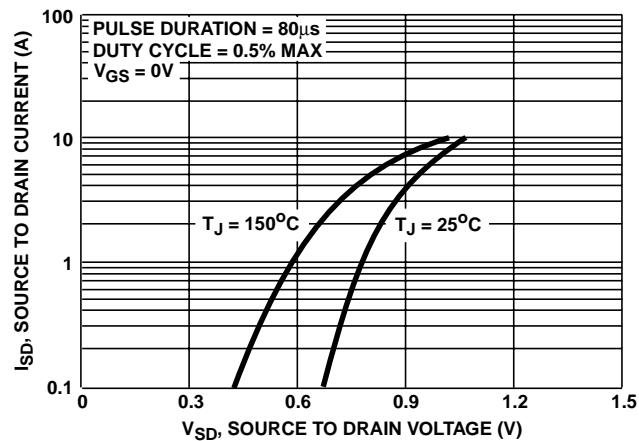

FIGURE 13. SOURCE TO DRAIN DIODE VOLTAGE

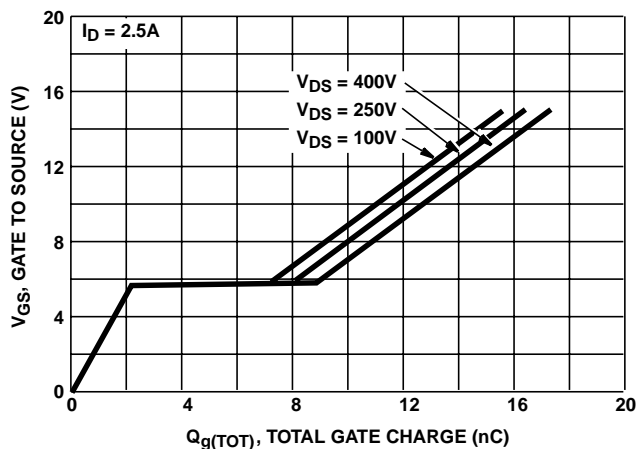

FIGURE 14. GATE TO SOURCE VOLTAGE vs GATE CHARGE

Test Circuits and Waveforms

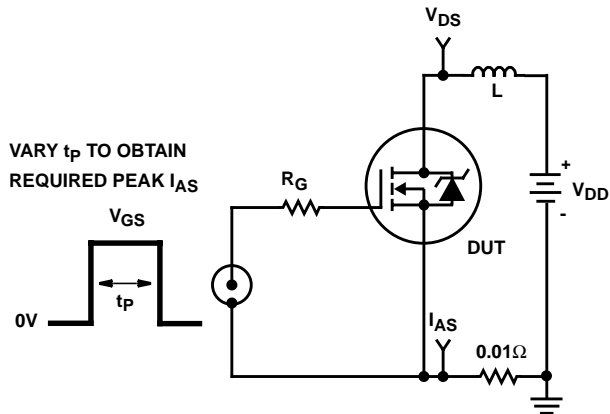

FIGURE 15. UNCLAMPED ENERGY TEST CIRCUIT

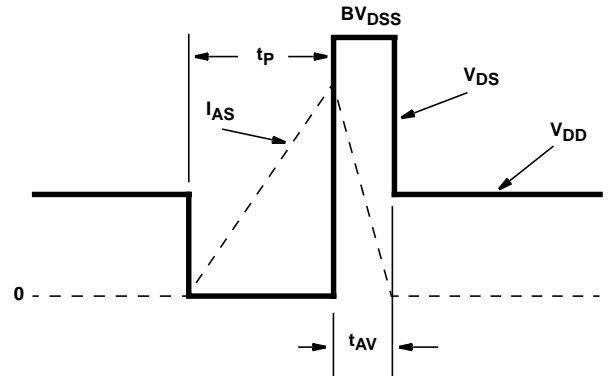

FIGURE 16. UNCLAMPED ENERGY WAVEFORMS

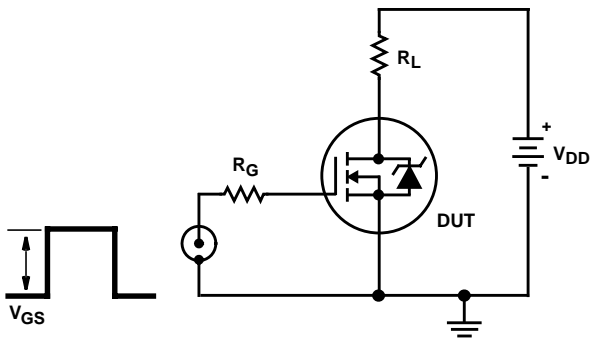

FIGURE 17. SWITCHING TIME TEST CIRCUIT

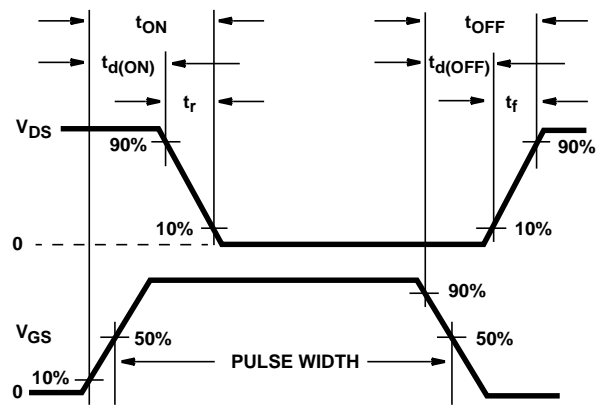

FIGURE 18. RESISTIVE SWITCHING WAVEFORMS

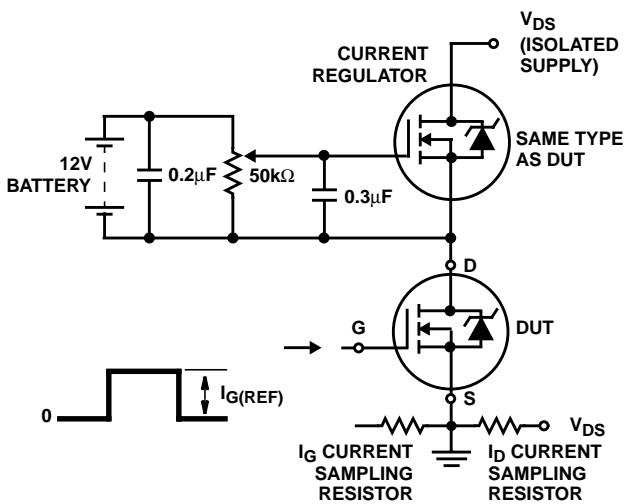

FIGURE 19. GATE CHARGE TEST CIRCUIT

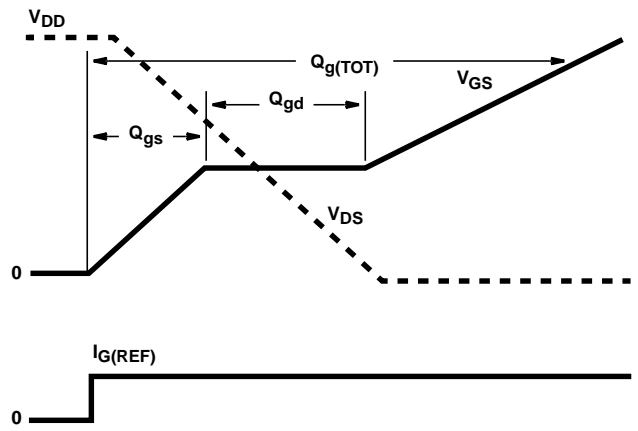

FIGURE 20. GATE CHARGE WAVEFORMS

All Intersil semiconductor products are manufactured, assembled and tested under **ISO9000** quality systems certification.

*Intersil semiconductor products are sold by description only. Intersil Corporation reserves the right to make changes in circuit design and/or specifications at any time without notice. Accordingly, the reader is cautioned to verify that data sheets are current before placing orders. Information furnished by Intersil is believed to be accurate and reliable. However, no responsibility is assumed by Intersil or its subsidiaries for its use; nor for any infringements of patents or other rights of third parties which may result from its use. No license is granted by implication or otherwise under any patent or patent rights of Intersil or its subsidiaries.*

For information regarding Intersil Corporation and its products, see web site <http://www.intersil.com>

### **Sales Office Headquarters**

#### **NORTH AMERICA**

Intersil Corporation  
P. O. Box 883, Mail Stop 53-204  
Melbourne, FL 32902  
TEL: (407) 724-7000  
FAX: (407) 724-7240

#### **EUROPE**

Intersil SA  
Mercure Center  
100, Rue de la Fusee  
1130 Brussels, Belgium  
TEL: (32) 2.724.2111  
FAX: (32) 2.724.22.05

#### **ASIA**

Intersil (Taiwan) Ltd.  
7F-6, No. 101 Fu Hsing North Road  
Taipei, Taiwan  
Republic of China  
TEL: (886) 2 2716 9310  
FAX: (886) 2 2715 3029