



CED3055L3/CEU3055L3

PRELIMINARY

Dual N-Channel Enhancement Mode Field Effect Transistor

FEATURES

- 30V , 3.7A , $R_{DS(ON)}=80m\Omega$ @ $V_{GS}=10V$.
 $R_{DS(ON)}=110m\Omega$ @ $V_{GS}=4.5V$.
- Super high dense cell design for extremely low $R_{DS(ON)}$.
- High power and current handling capability.
- TO-251 & TO-252 Package.

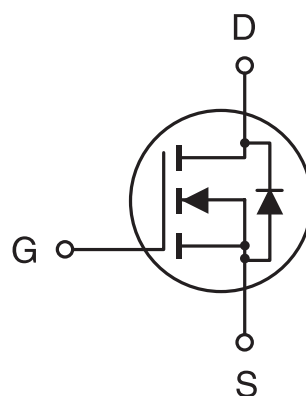

ABSOLUTE MAXIMUM RATINGS ($T_c=25^\circ\text{C}$ unless otherwise noted)

| Parameter | Symbol | Limit | Unit |
|---|----------------|------------|------------------|
| Drain-Source Voltage | V_{DS} | 30 | V |
| Gate-Source Voltage | V_{GS} | ± 20 | V |
| Drain Current-Continuous ^a @ $T_J=125^\circ\text{C}$ -Pulsed ^b | I_D | ± 3.7 | A |
| | I_{DM} | ± 15 | A |
| Drain-Source Diode Forward Current ^a | I_S | 1.2 | A |
| Maximum Power Dissipation ^a | P_D | 2 | W |
| Operating Junction and Storage Temperature Range | T_J, T_{STG} | -55 to 150 | $^\circ\text{C}$ |

THERMAL CHARACTERISTICS

| | | | |
|--|-----------------|----|--------------------|
| Thermal Resistance, Junction-to-Ambient ^a | $R_{\theta JA}$ | 78 | $^\circ\text{C/W}$ |
|--|-----------------|----|--------------------|

CED3055L3/CEU3055L3

ELECTRICAL CHARACTERISTICS (Tc=25°C unless otherwise noted)

6

| Parameter | Symbol | Condition | Min | Typ ^c | Max | Unit |
|--|---------------------|--|-----|------------------|------|------|
| OFF CHARACTERISTICS | | | | | | |
| Drain-Source Breakdown Voltage | BV _{DSS} | V _{GS} =0V, I _D =250μA | 30 | | | V |
| Zero Gate Voltage Drain Current | I _{DSS} | V _{DS} =24V, V _{GS} =0V | | | 1 | μA |
| Gate-Body Leakage | I _{GSS} | V _{GS} =±20V, V _{DS} =0V | | | ±100 | nA |
| ON CHARACTERISTICS^b | | | | | | |
| Gate Threshold Voltage | V _{GS(th)} | V _{DS} =V _{GS} , I _D =250μA | 1 | 1.6 | 3 | V |
| Drain-Source On-State Resistance | R _{DS(ON)} | V _{GS} =10V, I _D =2.2A | | 60 | 80 | mΩ |
| | | V _{GS} =4.5V, I _D =1.0A | | 80 | 110 | mΩ |
| On-State Drain Current | I _{D(ON)} | V _{DS} =10V, V _{GS} =10V | 15 | | | A |
| Forward Transconductance | g _{FS} | V _{DS} =10V, I _D =3.7A | 3 | 6 | | S |
| DYNAMIC CHARACTERISTICS^c | | | | | | |
| Input Capacitance | C _{ISS} | V _{DS} =10V, V _{GS} =0V f=1.0MHz | | 292 | 380 | pF |
| Output Capacitance | C _{OSS} | | | 120 | 160 | pF |
| Reverse Transfer Capacitance | C _{RSS} | | | 28 | 35 | pF |
| SWITCHING CHARACTERISTICS^c | | | | | | |
| Turn-On Delay Time | t _{D(ON)} | V _{DD} =10V, I _D =1A, V _{GEN} =10V, R _{GEN} =6Ω | | 15 | 20 | ns |
| Rise Time | t _r | | | 12 | 20 | ns |
| Turn-Off Delay Time | t _{D(OFF)} | | | 50 | 90 | ns |
| Fall Time | t _f | | | 15 | 50 | ns |
| Total Gate Charge | Q _g | V _{DS} =10V, I _D =3.7A, V _{GS} =10V | | 17 | 30 | nC |
| Gate-Source Charge | Q _{gs} | | | 3 | | nC |
| Gate-Drain Charge | Q _{gd} | | | 3 | | nC |

CED3055L3/CEU3055L3

ELECTRICAL CHARACTERISTICS (T_c=25°C unless otherwise noted)

| Parameter | Symbol | Condition | Min | Typ ^c | Max | Unit |
|---|-----------------|--|-----|------------------|-----|------|
| DRAIN-SOURCE DIODE CHARACTERISTICS^b | | | | | | |
| Diode Forward Voltage | V _{SD} | V _{GS} = 0V, I _s = 1.25A | | 0.8 | 1.4 | V |

6

Notes

- a. Surface Mounted on FR4 Board, t ≤ 10sec.
- b. Pulse Test: Pulse Width ≤ 300 μs, Duty Cycle ≤ 2%.
- c. Guaranteed by design, not subject to production testing.

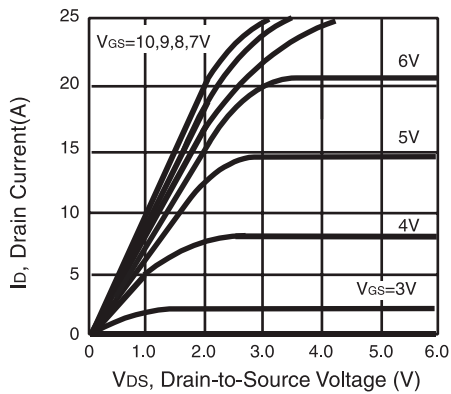

Figure 1. Output Characteristics

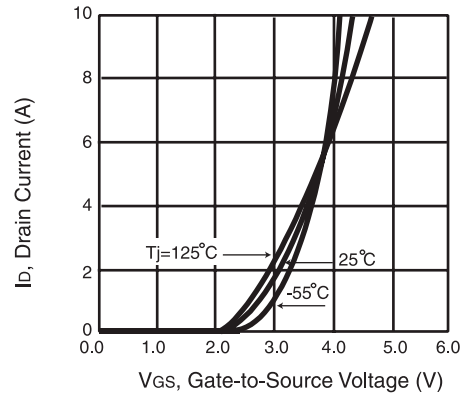

Figure 2. Transfer Characteristics

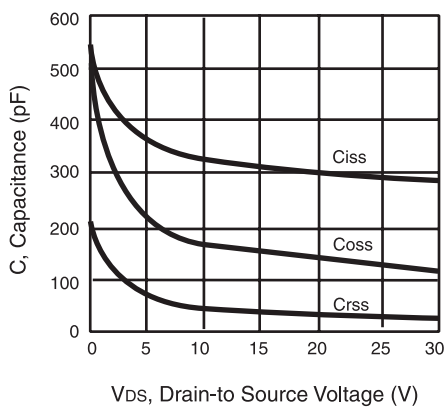

Figure 3. Capacitance

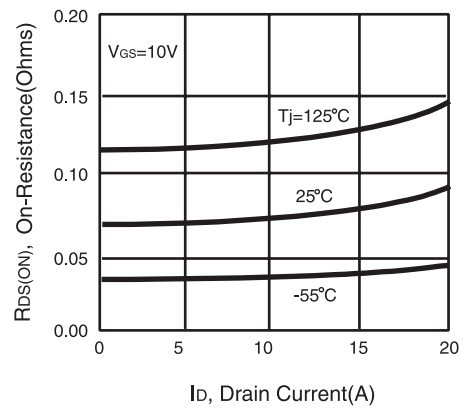

Figure 4. On-Resistance Variation with Drain Current and Temperature

CED3055L3/CEU3055L3

6

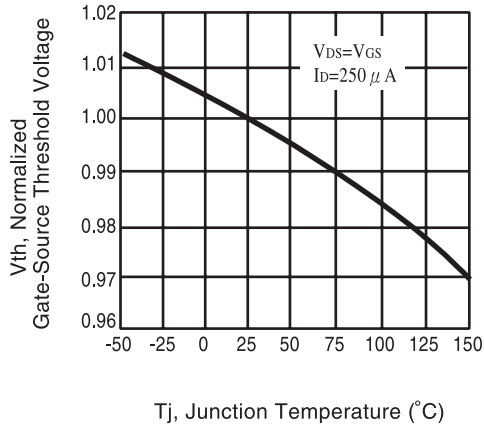

Figure 5. Gate Threshold Variation with Temperature

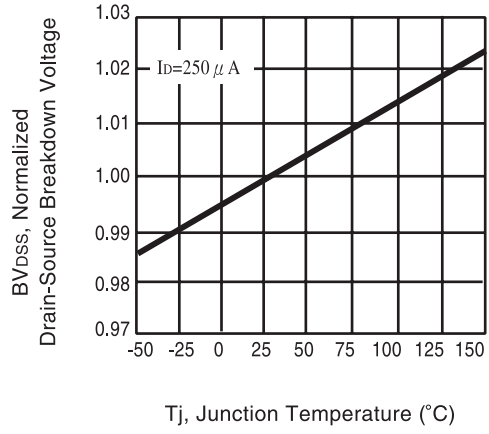

Figure 6. Breakdown Voltage Variation with Temperature

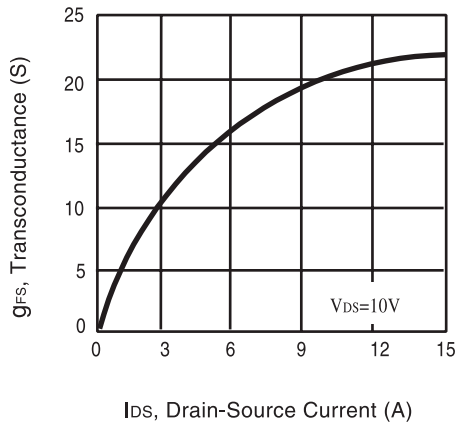

Figure 7. Transconductance Variation with Drain Current

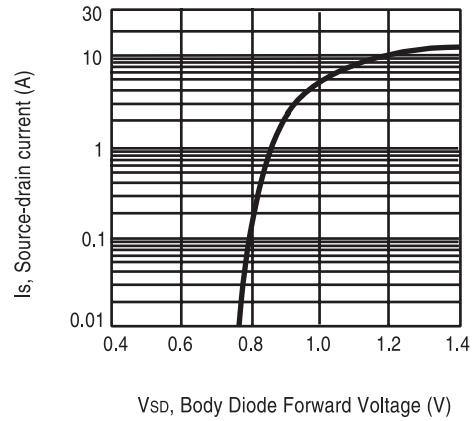

Figure 8. Body Diode Forward Voltage Variation with Source Current

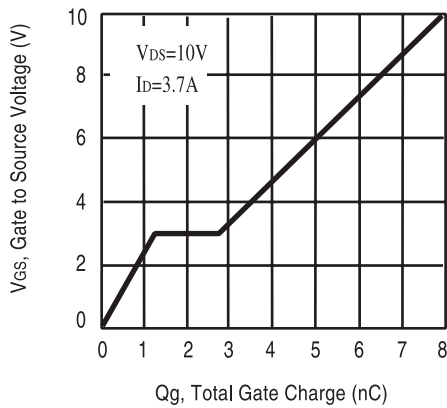

Figure 9. Gate Charge

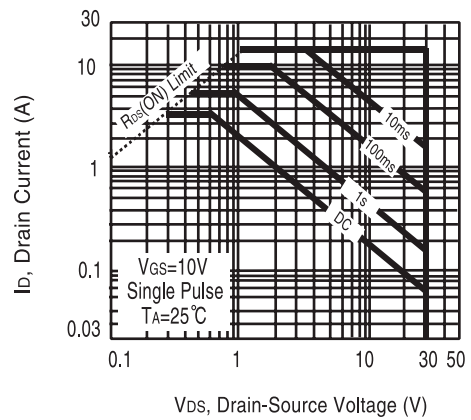

Figure 10. Maximum Safe Operating Area

CED3055L3/CEU3055L3

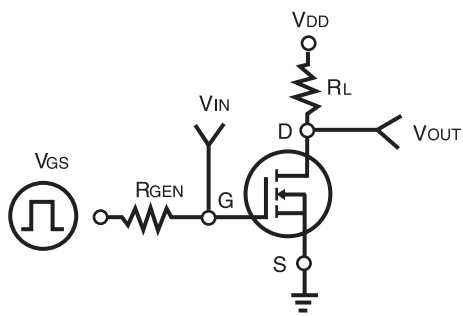

Figure 11. Switching Test Circuit

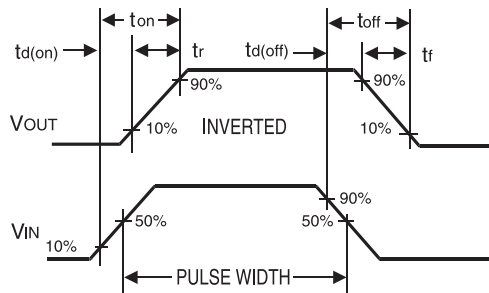

Figure 12. Switching Waveforms

6

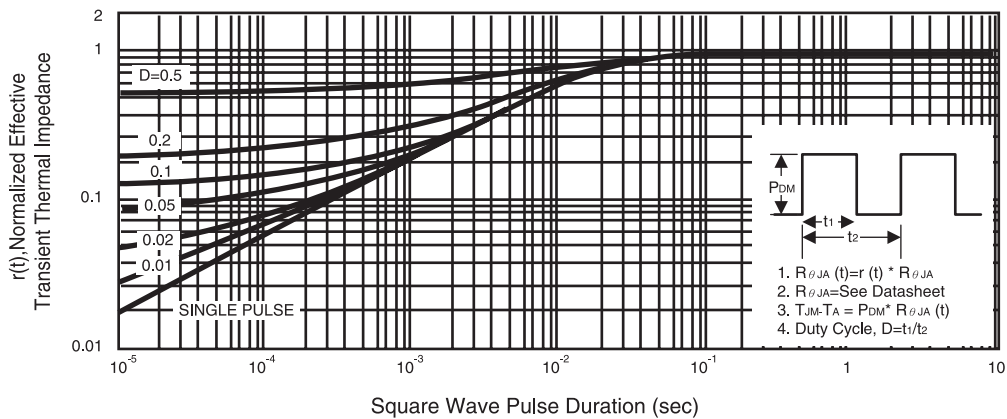

Figure 13. Normalized Thermal Transient Impedance Curve